

45 SERIES

- PRESSFIT NEON, LED & INCANDESCENT INDICATOR LIGHTS
- 5/16" DIA. MOUNTING HOLE
- WHITE NYLON HOUSING • 1/8" OR 3/16" TAB TERMINALS
- 2 TO 250 DESIGN VOLTS • FLUSH OR HI-HAT LENSES • VARIETY OF COLORS
- UL AND CSA RECOGNIZED • UL FILE E20356 • CSA FILE LR15284-17

Overview

The 45 Series Indicators feature a wide variety of lens colors and bezel variations. 45 Series Indicators are designed with 1/8" tab terminals or 3/16" tab terminals. Indicators mount into a 5/16", (7.93mm) mounting hole with a recommended panel thickness of 0.020" minimum. A speed nut, part number **8700071688**, is supplied.

Specifications

Housing: white nylon. A black housing is available.

Lens: polycarbonate.

Bezel: zinc plated brass. A black anodized bezel is available.

Incandescent AC or DC voltage options: 6, 14 and 28 volts.

Neon AC or DC voltage options: 125 and 250 volts.
Note: high brightness green and blue neon lamps supplied in green and blue neon applications.

LED DC voltage options: 2, 6, 12, 24.

Terminals:

1/8" Tabs: brass, (0.125" width x 0.020" thick).

3/16" Tabs: brass, (0.187" width x 0.020" thick). For LED units, a tin plated terminal denotes the anode (+).

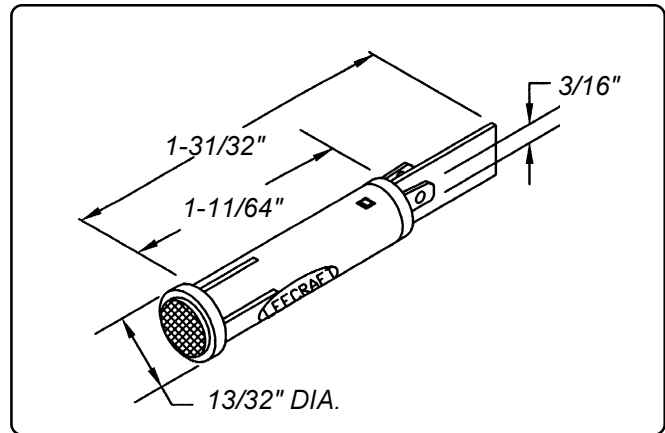

Flush Lens Style

Without bezel.

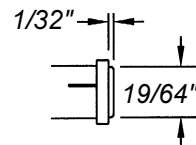

With bezel.

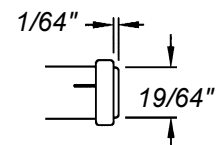

Hi-Hat Lens Style

Without bezel.

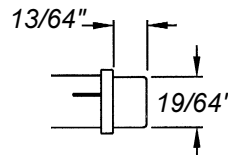

With bezel.

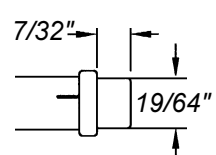

Can't find it here? We have many more standard and custom solutions.

For information phone Customer Service at 954-425-0123 or complete the "Fast FAX" form on Appendix, page A-1.

**45 Series
Units Without Bezels
White Housing
6 to 250 Design Volts
Neon or
Incandescent**

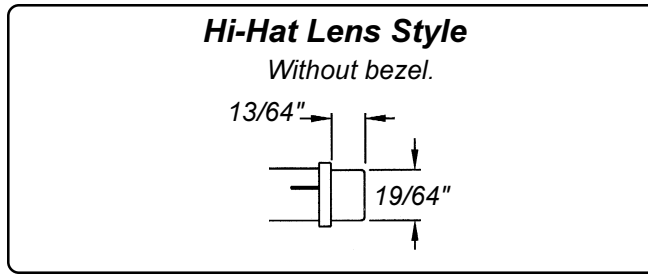

**Hi-Hat Lens
Variety of
Lens Colors
1/8" Tab Terminals or
3/16" Tab Terminals
PressFit Mounting**

Part Number 1/8" Tab Terminals	Part Number 3/16" Tab Terminals	Lens Color	Lamp Type	Design Volts	Design Watts or Amps	Life (hrs)
45N-2111	45N-2111T3	Red	Neon	125	1/3W	25,000
45HN-2111	45HN-2111T3	Red	Neon	250	1/3W	25,000
45NG1-2111	45NG1-2111T3	Red	Incandescent	6	.20A	5,000
45NG3-2111	45NG3-2111T3	Red	Incandescent	14	.10A	10,000
45NG18-2111	45NG18-2111T3	Red	Incandescent	28	.04A	7,000
45N-2112	45N-2112T3	Green	Neon	125	1/3W	25,000
45HN-2112	45HN-2112T3	Green	Neon	250	1/3W	25,000
45NG1-2112	45NG1-2112T3	Green	Incandescent	6	.20A	5,000
45NG3-2112	45NG3-2112T3	Green	Incandescent	14	.10A	10,000
45NG18-2112	45NG18-2112T3	Green	Incandescent	28	.04A	7,000
45N-2113	45N-2113T3	Amber	Neon	125	1/3W	25,000
45HN-2113	45HN-2113T3	Amber	Neon	250	1/3W	25,000
45NG1-2113	45NG1-2113T3	Amber	Incandescent	6	.20A	5,000
45NG3-2113	45NG3-2113T3	Amber	Incandescent	14	.10A	10,000
45NG18-2113	45NG18-2113T3	Amber	Incandescent	28	.04A	7,000
45N-2114	45N-2114T3	Blue	Neon	125	1/3W	25,000
45HN-2114	45HN-2114T3	Blue	Neon	250	1/3W	25,000
45NG1-2114	45NG1-2114T3	Blue	Incandescent	6	.20A	5,000
45NG3-2114	45NG3-2114T3	Blue	Incandescent	14	.10A	10,000
45NG18-2114	45NG18-2114T3	Blue	Incandescent	28	.04A	7,000
45N-2115	45N-2115T3	White	Neon	125	1/3W	25,000
45HN-2115	45HN-2115T3	White	Neon	250	1/3W	25,000
45NG1-2115	45NG1-2115T3	White	Incandescent	6	.20A	5,000
45NG3-2115	45NG3-2115T3	White	Incandescent	14	.10A	10,000
45NG18-2115	45NG18-2115T3	White	Incandescent	28	.04A	7,000
45N-2117	45N-2117T3	Clear	Neon	125	1/3W	25,000
45HN-2117	45HN-2117T3	Clear	Neon	250	1/3W	25,000
45NG1-2117	45NG1-2117T3	Clear	Incandescent	6	.20A	5,000
45NG3-2117	45NG3-2117T3	Clear	Incandescent	14	.10A	10,000
45NG18-2117	45NG18-2117T3	Clear	Incandescent	28	.04A	7,000

**45 Series
Zinc Plated Bezel
White Housing
6 to 250 Design Volts
Neon or
Incandescent**

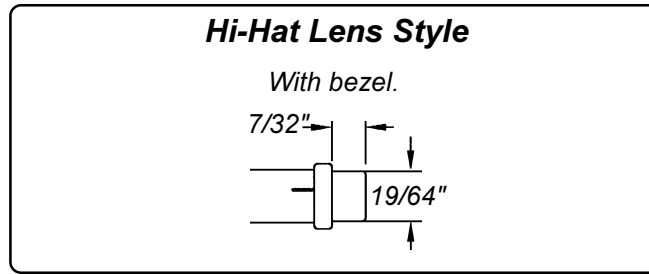

**Hi-Hat Lens
Variety of
Lens Colors
1/8" Tab Terminals or
3/16" Tab Terminals
PressFit Mounting**

Part Number 1/8" Tab Terminals	Part Number 3/16" Tab Terminals	Lens Color	Lamp Type	Design Volts	Design Watts or Amps	Life (hrs)
45RN-2111	45RN-2111T3	Red	Neon	125	1/3W	25,000
45HRN-2111	45HRN-2111T3	Red	Neon	250	1/3W	25,000
45RNG1-2111	45RNG1-2111T3	Red	Incandescent	6	.20A	5,000
45RNG3-2111	45RNG3-2111T3	Red	Incandescent	14	.10A	10,000
45RNG18-2111	45RNG18-2111T3	Red	Incandescent	28	.04A	7,000
45RN-2112	45RN-2112T3	Green	Neon	125	1/3W	25,000
45HRN-2112	45HRN-2112T3	Green	Neon	250	1/3W	25,000
45RNG1-2112	45RNG1-2112T3	Green	Incandescent	6	.20A	5,000
45RNG3-2112	45RNG3-2112T3	Green	Incandescent	14	.10A	10,000
45RNG18-2112	45RNG18-2112T3	Green	Incandescent	28	.04A	7,000
45RN-2113	45RN-2113T3	Amber	Neon	125	1/3W	25,000
45HRN-2113	45HRN-2113T3	Amber	Neon	250	1/3W	25,000
45RNG1-2113	45RNG1-2113T3	Amber	Incandescent	6	.20A	5,000
45RNG3-2113	45RNG3-2113T3	Amber	Incandescent	14	.10A	10,000
45RNG18-2113	45RNG18-2113T3	Amber	Incandescent	28	.04A	7,000
45RN-2114	45RN-2114T3	Blue	Neon	125	1/3W	25,000
45HRN-2114	45HRN-2114T3	Blue	Neon	250	1/3W	25,000
45RNG1-2114	45RNG1-2114T3	Blue	Incandescent	6	.20A	5,000
45RNG3-2114	45RNG3-2114T3	Blue	Incandescent	14	.10A	10,000
45RNG18-2114	45RNG18-2114T3	Blue	Incandescent	28	.04A	7,000
45RN-2115	45RN-2115T3	White	Neon	125	1/3W	25,000
45HRN-2115	45HRN-2115T3	White	Neon	250	1/3W	25,000
45RNG1-2115	45RNG1-2115T3	White	Incandescent	6	.20A	5,000
45RNG3-2115	45RNG3-2115T3	White	Incandescent	14	.10A	10,000
45RNG18-2115	45RNG18-2115T3	White	Incandescent	28	.04A	7,000
45RN-2117	45RN-2117T3	Clear	Neon	125	1/3W	25,000
45HRN-2117	45HRN-2117T3	Clear	Neon	250	1/3W	25,000
45RNG1-2117	45RNG1-2117T3	Clear	Incandescent	6	.20A	5,000
45RNG3-2117	45RNG3-2117T3	Clear	Incandescent	14	.10A	10,000
45RNG18-2117	45RNG18-2117T3	Clear	Incandescent	28	.04A	7,000

Indicator Lights

**45 Series
Units without Bezels
White Housing
6 to 250 Design Volts
Neon or
Incandescent**

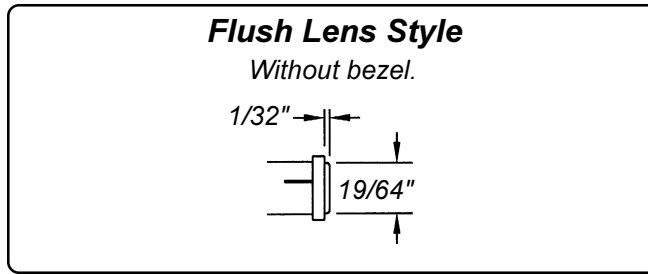

**Flush Lens
Variety of
Lens Colors
1/8" Tab Terminals or
3/16" Tab Terminals
PressFit Mounting**

Part Number 1/8" Tab Terminals	Part Number 3/16" Tab Terminals	Lens Color	Lamp Type	Design Volts	Design Watts or Amps	Life (hrs)
45N-2311	45N-2311T3	Red	Neon	125	1/3W	25,000
45HN-2311	45HN-2311T3	Red	Neon	250	1/3W	25,000
45NG1-2311	45NG1-2311T3	Red	Incandescent	6	.20A	5,000
45NG3-2311	45NG3-2311T3	Red	Incandescent	14	.10A	10,000
45NG18-2311	45NG18-2311T3	Red	Incandescent	28	.04A	7,000
45N-2312	45N-2312T3	Green	Neon	125	1/3W	25,000
45HN-2312	45HN-2312T3	Green	Neon	250	1/3W	25,000
45NG1-2312	45NG1-2312T3	Green	Incandescent	6	.20A	5,000
45NG3-2312	45NG3-2312T3	Green	Incandescent	14	.10A	10,000
45NG18-2312	45NG18-2312T3	Green	Incandescent	28	.04A	7,000
45N-2313	45N-2313T3	Amber	Neon	125	1/3W	25,000
45HN-2313	45HN-2313T3	Amber	Neon	250	1/3W	25,000
45NG1-2313	45NG1-2313T3	Amber	Incandescent	6	.20A	5,000
45NG3-2313	45NG3-2313T3	Amber	Incandescent	14	.10A	10,000
45NG18-2313	45NG18-2313T3	Amber	Incandescent	28	.04A	7,000
45N-2314	45N-2314T3	Blue	Neon	125	1/3W	25,000
45HN-2314	45HN-2314T3	Blue	Neon	250	1/3W	25,000
45NG1-2314	45NG1-2314T3	Blue	Incandescent	6	.20A	5,000
45NG3-2314	45NG3-2314T3	Blue	Incandescent	14	.10A	10,000
45NG18-2314	45NG18-2314T3	Blue	Incandescent	28	.04A	7,000
45N-2315	45N-2315T3	White	Neon	125	1/3W	25,000
45HN-2315	45HN-2315T3	White	Neon	250	1/3W	25,000
45NG1-2315	45NG1-2315T3	White	Incandescent	6	.20A	5,000
45NG3-2315	45NG3-2315T3	White	Incandescent	14	.10A	10,000
45NG18-2315	45NG18-2315T3	White	Incandescent	28	.04A	7,000
45N-2317	45N-2317T3	Clear	Neon	125	1/3W	25,000
45HN-2317	45HN-2317T3	Clear	Neon	250	1/3W	25,000
45NG1-2317	45NG1-2317T3	Clear	Incandescent	6	.20A	5,000
45NG3-2317	45NG3-2317T3	Clear	Incandescent	14	.10A	10,000
45NG18-2317	45NG18-2317T3	Clear	Incandescent	28	.04A	7,000

**45 Series
Zinc Plated Bezel
White Housing
6 to 250 Design Volts
Neon or
Incandescent**

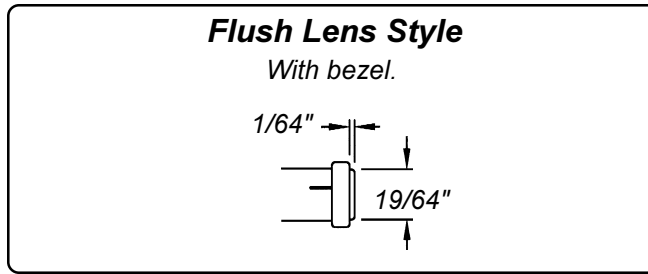

**Flush Lens
Variety of
Lens Colors
1/8" Tab Terminals
3/16" Tab Terminals
PressFit Mounting**

Part Number 1/8" Tab Terminals	Part Number 3/16" Tab Terminals	Lens Color	Lamp Type	Design Volts	Design Watts or Amps	Life (hrs)
45RN-2311	45RN-2311T3	Red	Neon	125	1/3W	25,000
45HRN-2311	45HRN-2311T3	Red	Neon	250	1/3W	25,000
45RNG1-2311	45RNG1-2311T3	Red	Incandescent	6	.20A	5,000
45RNG3-2311	45RNG3-2311T3	Red	Incandescent	14	.10A	10,000
45RNG18-2311	45RNG18-2311T3	Red	Incandescent	28	.04A	7,000
45RN-2312	45RN-2312T3	Green	Neon	125	1/3W	25,000
45HRN-2312	45HRN-2312T3	Green	Neon	250	1/3W	25,000
45RNG1-2312	45RNG1-2312T3	Green	Incandescent	6	.20A	5,000
45RNG3-2312	45RNG3-2312T3	Green	Incandescent	14	.10A	10,000
45RNG18-2312	45RNG18-2312T3	Green	Incandescent	28	.04A	7,000
45RN-2313	45RN-2313T3	Amber	Neon	125	1/3W	25,000
45HRN-2313	45HRN-2313T3	Amber	Neon	250	1/3W	25,000
45RNG1-2313	45RNG1-2313T3	Amber	Incandescent	6	.20A	5,000
45RNG3-2313	45RNG3-2313T3	Amber	Incandescent	14	.10A	10,000
45RNG18-2313	45RNG18-2313T3	Amber	Incandescent	28	.04A	7,000
45RN-2314	45RN-2314T3	Blue	Neon	125	1/3W	25,000
45HRN-2314	45HRN-2314T3	Blue	Neon	250	1/3W	25,000
45RNG1-2314	45RNG1-2314T3	Blue	Incandescent	6	.20A	5,000
45RNG3-2314	45RNG3-2314T3	Blue	Incandescent	14	.10A	10,000
45RNG18-2314	45RNG18-2314T3	Blue	Incandescent	28	.04A	7,000
45RN-2315	45RN-2315T3	White	Neon	125	1/3W	25,000
45HRN-2315	45HRN-2315T3	White	Neon	250	1/3W	25,000
45RNG1-2315	45RNG1-2315T3	White	Incandescent	6	.20A	5,000
45RNG3-2315	45RNG3-2315T3	White	Incandescent	14	.10A	10,000
45RNG18-2315	45RNG18-2315T3	White	Incandescent	28	.04A	7,000
45RN-2317	45RN-2317T3	Clear	Neon	125	1/3W	25,000
45HRN-2317	45HRN-2317T3	Clear	Neon	250	1/3W	25,000
45RNG1-2317	45RNG1-2317T3	Clear	Incandescent	6	.20A	5,000
45RNG3-2317	45RNG3-2317T3	Clear	Incandescent	14	.10A	10,000
45RNG18-2317	45RNG18-2317T3	Clear	Incandescent	28	.04A	7,000

Indicator Lights

**L45 Series
LED Indicator Lights
Zinc Plated Bezel
White Housing
2 to 24 Design Volts
PressFit Mounting**

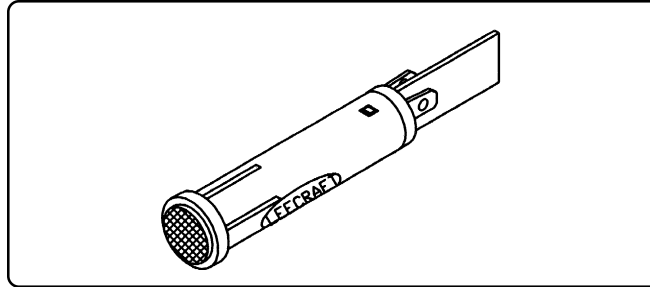

**Hi-Hat Lens or
Flush Lens
Variety of
Lens Colors
3/16" Tab Terminals
5/16" Mounting Hole**

Part Number With Hi-Hat Lens 3/16" Tab Terminals	Part Number With Flush Lens 3/16" Tab Terminals	Lens Color	DC Design Volts
L45RN-A2-2113	L45RN-A2-2313	Amber	2
L45RN-A6-2113	L45RN-A6-2313	Amber	6
L45RN-A12-2113	L45RN-A12-2313	Amber	12
L45RN-A24-2113	L45RN-A24-2313	Amber	24
L45RN-G2-2112	L45RN-G2-2312	Green	2
L45RN-G6-2112	L45RN-G6-2312	Green	6
L45RN-G12-2112	L45RN-G12-2312	Green	12
L45RN-G24-2112	L45RN-G24-2312	Green	24
L45RN-R2-2111	L45RN-R2-2311	Red	2
L45RN-R6-2111	L45RN-R6-2311	Red	6
L45RN-R12-2111	L45RN-R12-2311	Red	12
L45RN-R24-2111	L45RN-R24-2311	Red	24
L45RN-Y2-2116	L45RN-Y2-2316	Yellow	2
L45RN-Y6-2116	L45RN-Y6-2316	Yellow	6
L45RN-Y12-2116	L45RN-Y12-2316	Yellow	12
L45RN-Y24-2116	L45RN-Y24-2316	Yellow	24

Polarity Determination - Tab Terminals: One tab terminal is tin plated to denote anode (+); one tab terminal is unplated to designate the cathode (-).

