

## GaAs IR Emitting Diodes in Hermetically Sealed TO-18 Case

### Description

TSTS710. series are infrared emitting diodes in standard GaAs technology in a hermetically sealed TO-18 package. Their glass lenses provide a very high radiant intensity without external optics.

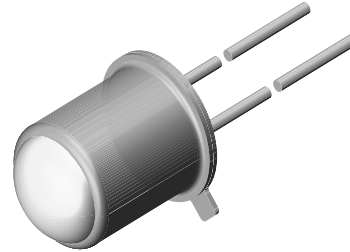

94 8483

### Features

- Very high radiant intensity
- Suitable for pulse operation
- Narrow angle of half intensity  $\phi = \pm 5^\circ$
- Peak wavelength  $\lambda_p = 950 \text{ nm}$
- High reliability
- Good spectral matching to Si photodetectors
- Lead-free device

### Applications

Radiation source in near infrared range

### Absolute Maximum Ratings

$T_{amb} = 25^\circ\text{C}$ , unless otherwise specified

Parameter	Test condition	Symbol	Value	Unit
Reverse Voltage		$V_R$	5	V
Forward current	$T_{case} \leq 25^\circ\text{C}$	$I_F$	250	mA
Peak Forward Current	$t_p/T = 0.5$ , $t_p \leq 100 \mu\text{s}$ , $T_{case} \leq 25^\circ\text{C}$	$I_{FM}$	500	mA
Surge Forward Current	$t_p \leq 100 \mu\text{s}$	$I_{FSM}$	2.5	A
Power Dissipation		$P_V$	170	mW
	$T_{case} \leq 25^\circ\text{C}$	$P_V$	500	mW
Junction Temperature		$T_j$	100	$^\circ\text{C}$
Storage Temperature Range		$T_{stg}$	- 55 to + 100	$^\circ\text{C}$
Thermal Resistance Junction/ Ambient		$R_{thJA}$	450	K/W
Thermal Resistance Junction/ Case		$R_{thJC}$	150	K/W

### Electrical Characteristics

$T_{amb} = 25^\circ\text{C}$ , unless otherwise specified

Parameter	Test condition	Symbol	Min	Typ.	Max	Unit
Forward Voltage	$I_F = 100 \text{ mA}$ , $t_p \leq 20 \text{ ms}$	$V_F$		1.3	1.7	V
Breakdown Voltage	$I_R = 100 \mu\text{A}$	$V_{(BR)}$	5			V
Junction capacitance	$V_R = 0 \text{ V}$ , $f = 1 \text{ MHz}$ , $E = 0$	$C_j$		30		pF

### Optical Characteristics

$T_{amb} = 25\text{ }^{\circ}\text{C}$ , unless otherwise specified

Parameter	Test condition	Symbol	Min	Typ.	Max	Unit
Radiant Power	$I_F = 100\text{ mA}$ , $t_p \leq 20\text{ ms}$	$\phi_e$		7		mW
Temp. Coefficient of $\phi_e$	$I_F = 100\text{ mA}$	$TK_{\phi_e}$		- 0.8		%/K
Angle of Half Intensity		$\varphi$		$\pm 5$		deg
Peak Wavelength	$I_F = 100\text{ mA}$	$\lambda_p$		950		nm
Spectral Bandwidth	$I_F = 100\text{ mA}$	$\Delta\lambda$		50		nm
Rise Time	$I_F = 1.5\text{ A}$ , $t_p/T = 0.01$ , $t_p \leq 10\text{ }\mu\text{s}$	$t_r$		400		ns
Fall Time	$I_F = 1.5\text{ A}$ , $t_p/T = 0.01$ , $t_p \leq 10\text{ }\mu\text{s}$	$t_f$		400		ns
Virtual Source Diameter		$\emptyset$		1.5		mm

### Type Dedicated Characteristics

$T_{amb} = 25\text{ }^{\circ}\text{C}$ , unless otherwise specified

Parameter	Test condition	Symbol	Min	Typ.	Max	Unit
Radiant Intensity	$I_F = 100\text{ mA}$ , $t_p = 20\text{ ms}$	$I_e$	10		50	mW/sr
		$I_e$	12.5		25	mW/sr
		$I_e$	20		40	mW/sr
		$I_e$	32		64	mW/sr

### Typical Characteristics ( $T_{amb} = 25\text{ }^{\circ}\text{C}$ unless otherwise specified)

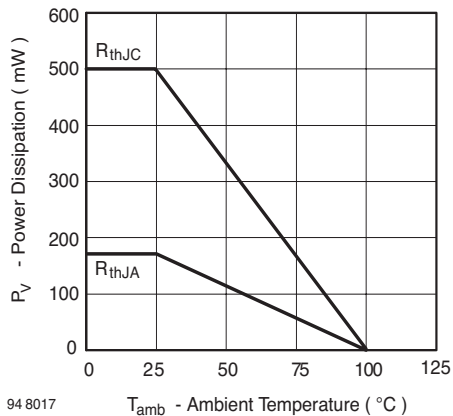

Figure 1. Power Dissipation vs. Ambient Temperature

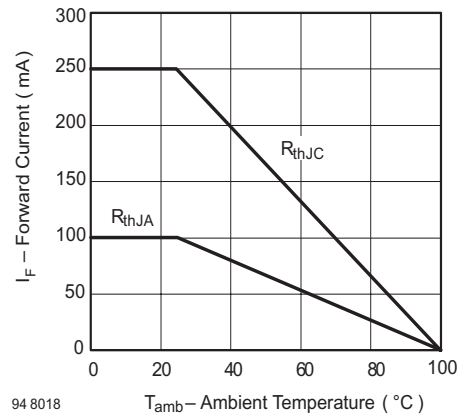
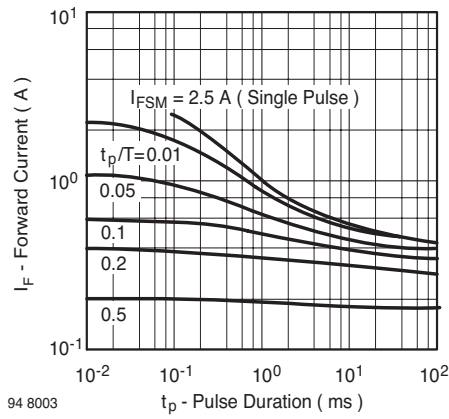
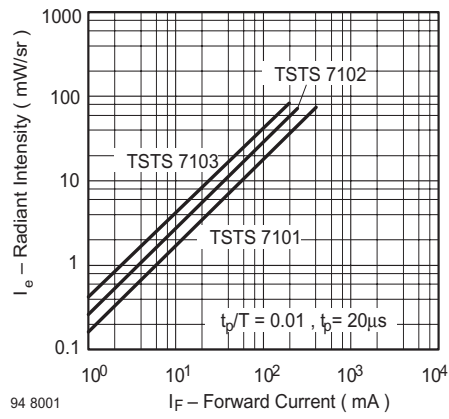

Figure 2. Forward Current vs. Ambient Temperature



94 8003

Figure 3. Pulse Forward Current vs. Pulse Duration



94 8001

Figure 6. Radiant Intensity vs. Forward Current

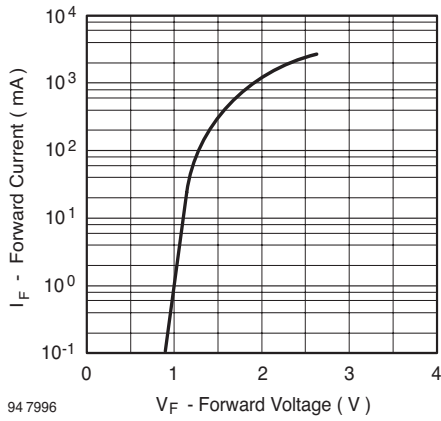

94 7996

Figure 4. Forward Current vs. Forward Voltage

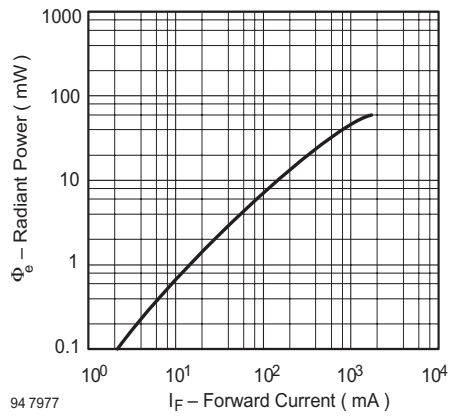

94 7977

Figure 7. Radiant Power vs. Forward Current

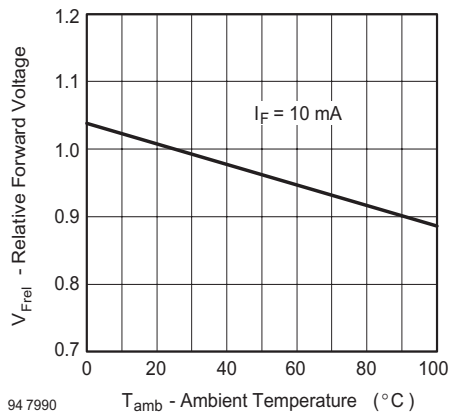

94 7990

Figure 5. Relative Forward Voltage vs. Ambient Temperature

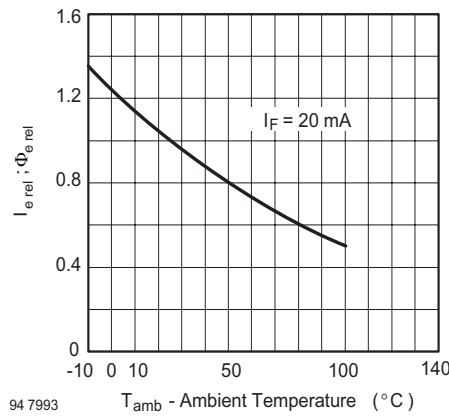

94 7993

Figure 8. Rel. Radiant Intensity/Power vs. Ambient Temperature

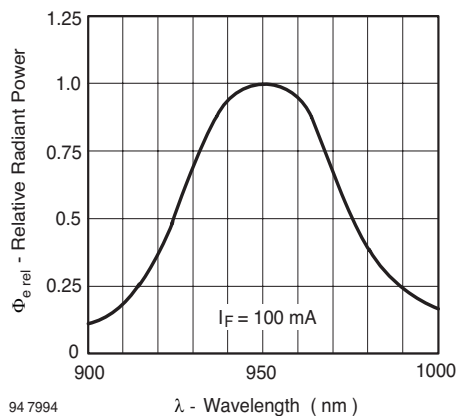

Figure 9. Relative Radiant Power vs. Wavelength

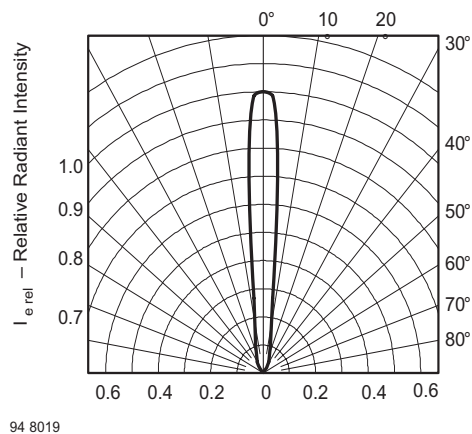
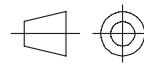
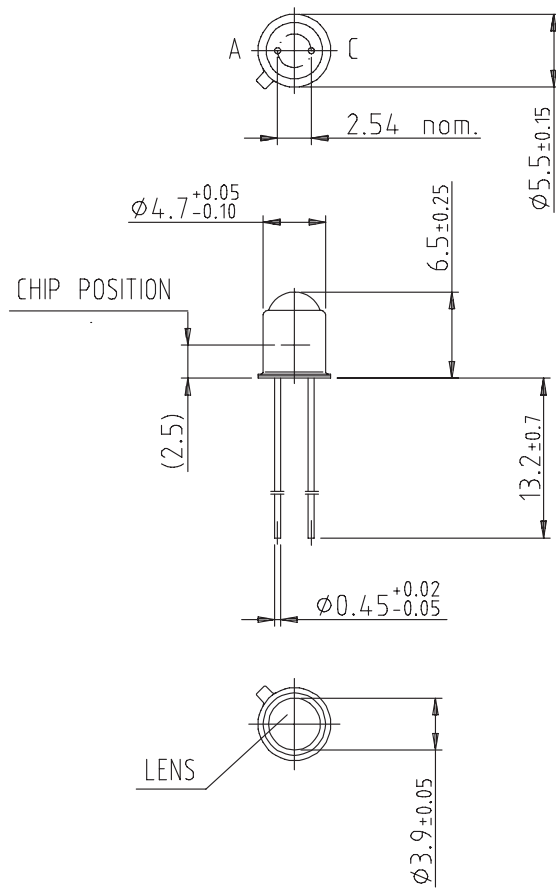

Figure 10. Relative Radiant Intensity vs. Angular Displacement

## Package Dimensions in mm



technical drawings  
according to DIN  
specifications

14486

### Ozone Depleting Substances Policy Statement

It is the policy of **Vishay Semiconductor GmbH** to

1. Meet all present and future national and international statutory requirements.
2. Regularly and continuously improve the performance of our products, processes, distribution and operating systems with respect to their impact on the health and safety of our employees and the public, as well as their impact on the environment.

It is particular concern to control or eliminate releases of those substances into the atmosphere which are known as ozone depleting substances (ODSs).

The Montreal Protocol (1987) and its London Amendments (1990) intend to severely restrict the use of ODSs and forbid their use within the next ten years. Various national and international initiatives are pressing for an earlier ban on these substances.

**Vishay Semiconductor GmbH** has been able to use its policy of continuous improvements to eliminate the use of ODSs listed in the following documents.

1. Annex A, B and list of transitional substances of the Montreal Protocol and the London Amendments respectively
2. Class I and II ozone depleting substances in the Clean Air Act Amendments of 1990 by the Environmental Protection Agency (EPA) in the USA
3. Council Decision 88/540/EEC and 91/690/EEC Annex A, B and C (transitional substances) respectively.

**Vishay Semiconductor GmbH** can certify that our semiconductors are not manufactured with ozone depleting substances and do not contain such substances.

**We reserve the right to make changes to improve technical design  
and may do so without further notice.**

Parameters can vary in different applications. All operating parameters must be validated for each customer application by the customer. Should the buyer use Vishay Semiconductors products for any unintended or unauthorized application, the buyer shall indemnify Vishay Semiconductors against all claims, costs, damages, and expenses, arising out of, directly or indirectly, any claim of personal damage, injury or death associated with such unintended or unauthorized use.

Vishay Semiconductor GmbH, P.O.B. 3535, D-74025 Heilbronn, Germany  
Telephone: 49 (0)7131 67 2831, Fax number: 49 (0)7131 67 2423