

DESCRIPTION

- 250 MHz SAW bandpass filter with 80 MHz bandwidth.
- 5 x 5 mm LCC package.
- RoHS compliant.

TYPICAL PERFORMANCE

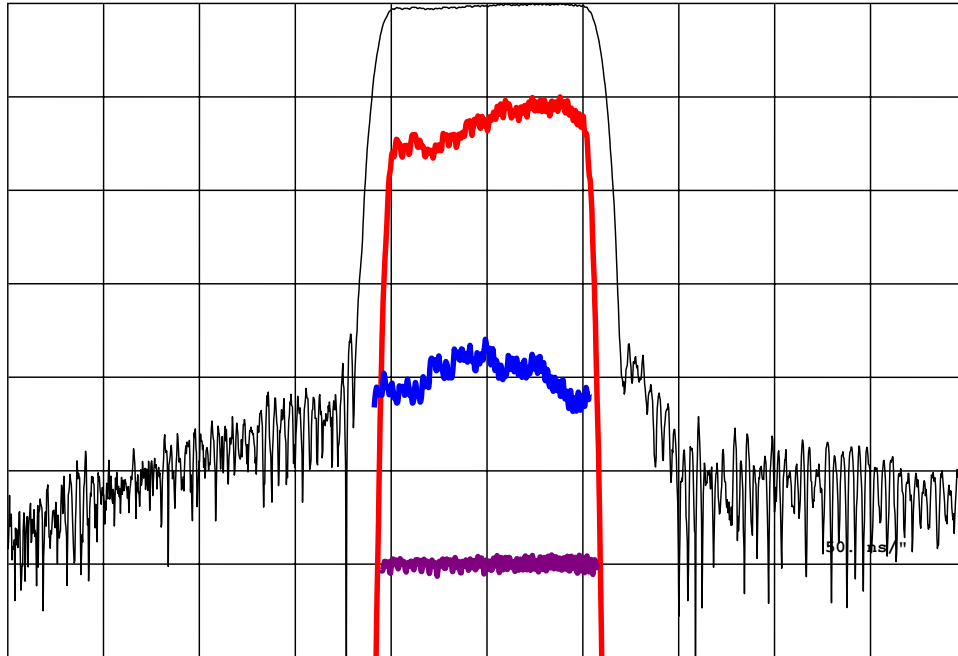

Horizontal: Frequency : 40 MHz/div
 Vertical from Top: Relative Magnitude : 10 dB/div
 Relative magnitude : 1 dB/div
 Phase Linearity : 5 deg/div
 Group Delay Deviation : 50 ns/div

S11 (50 to 450 MHz)

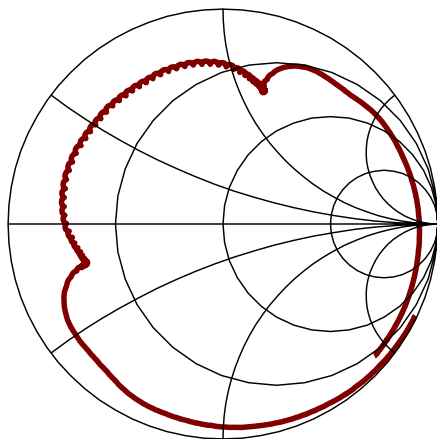

S22 (50 to 450 MHz)

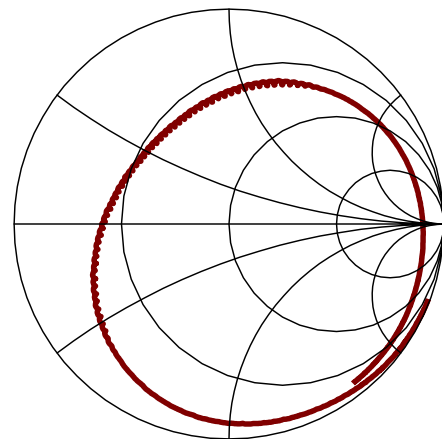

SPECIFICATION

Parameter ²	Min	Typ	Max	Units
Center Frequency (Fc) ¹	-	250	-	MHz
Minimum Insertion Loss	-	19.4	20.5	dB
1 dB Bandwidth	80.0	84.0	-	MHz
Lower 33 dB Band Edge ²	192.5	195.8	-	MHz
Upper 33 dB Band Edge ²	-	304.6	307.5	MHz
Rejection (0.3 to 30 MHz)	30	40	-	dB
Rejection (30 MHz to 150 MHz)	40	48	-	dB
Rejection (150 to 186 MHz)	38	40	-	dB
Rejection (186 to 192.5 MHz)	33	35	-	dB
Rejection (307.5 to 316 MHz)	33	35	-	dB
Rejection (316 to 320 MHz)	38	41	-	dB
Rejection (320 to 500 MHz)	40	45	-	dB
Passband Ripple (210 to 290 MHz) ³	-	0.7	1.0	dB p-p
Passband Ripple (209 to 291 MHz) ³	-	0.8	1.5	dB p-p
Phase Linearity (210 to 290 MHz) ³	-	4.5	8	deg p-p
Group Delay Deviation (210 to 290 MHz) ³	-	25	50	ns p-p
Source and Load Impedance	-	50	-	Ω
Ambient Temperature (Tref)	-	25	-	$^{\circ}$ C

- Notes:
1. Average of the lower and upper 3 dB frequencies.
 2. All dB levels are relative to the insertion loss.
 3. These specifications apply over the full operating temperature range.
 4. Typical change of filter frequency response with temperature is $\Delta f = (T - T_{ref}) * Tc * Fc$, in ppm.

MAXIMUM RATINGS

Parameter	Min	Typ	Max	Units
Storage Temperature Range	-40	25	85	$^{\circ}$ C
Operating Temperature Range (T)	-20	25	85	$^{\circ}$ C
Temperature Coefficient of Frequency (Tc) ⁴	-	-74	-	ppm/ $^{\circ}$ C
Input Power Level	-	10	13	dBm

MATCHING CIRCUIT

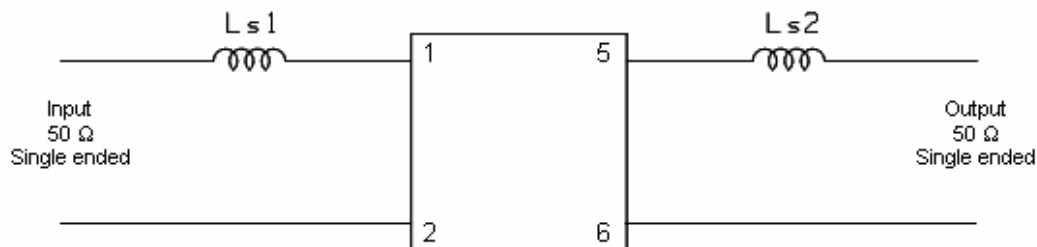

Typical component values:

$$L_{s1} = 47 \text{ nH}$$

$$L_{s2} = 68 \text{ nH}$$

Notes:

1. Recommend use of 2% tolerance matching components. Inductor Q=45.
2. Component values are for reference only and may change depending on board layout.

PACKAGE OUTLINE

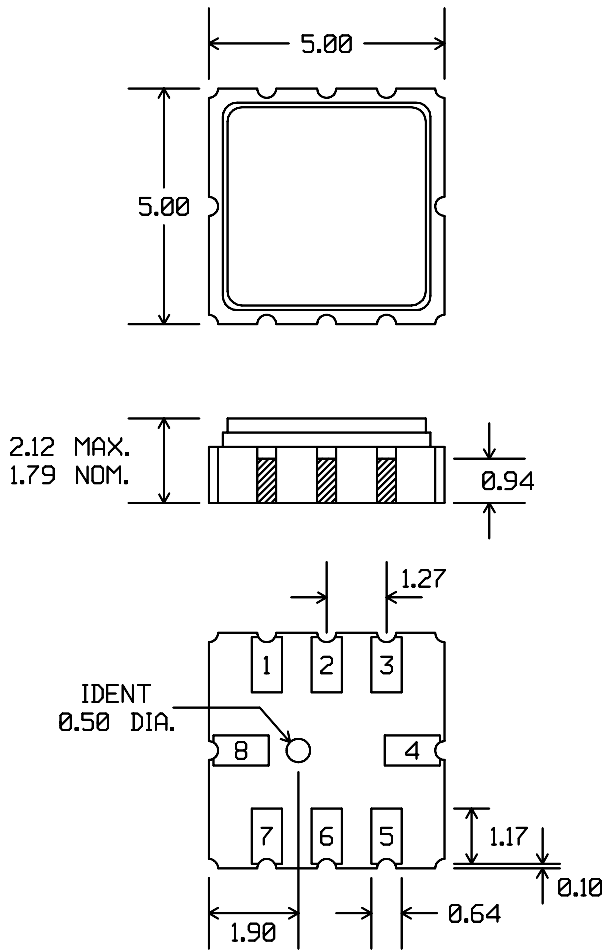

Package Material:
Body: Al_2O_3 ceramic
Lid: Kovar, Ni plated
Terminations: Au plating 1 μ m min,
over a 1.3-8.9 μ m Ni plating

SUGGESTED FOOTPRINT

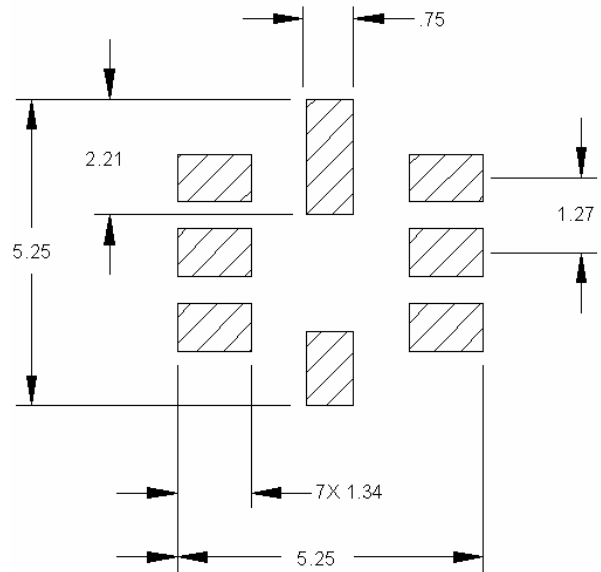

Units: mm

Tolerances are ± 0.15 mm except where indicated.

Pad Configuration:

- Input: 1
- Input return: 2
- Output: 5
- Output return: 6
- Ground: 3,4,7,8

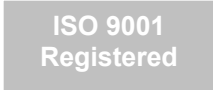

All specifications are believed to be accurate and reliable. However, Spectrum Microwave reserves the right to make changes without notice.
© 2010 All rights reserved.