

DC-DC Converter DATA Sheet

MPDTY321S

1. Features

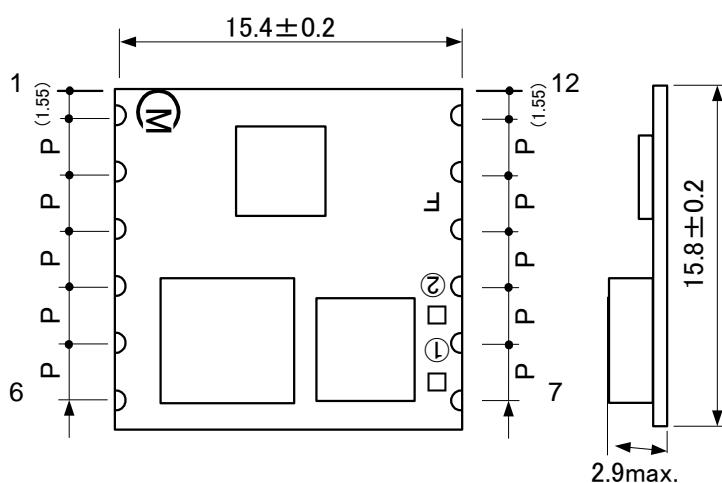

- Up to 4A output current, very small & low profile non-isolated POL.
- Wide adjustable output voltage range by connecting external resistance (0.8V to 3.3V).
- Wide operating temperature (-40°C to +85°C) .
- ON/OFF function, Output voltage sense function, Over-current function are built in.

2. Appearance, Dimensions



P=2.54 ±0.2mm
Tolerance is not accumulated.

Marking

- (1) Pin No.1 Marking / MFG ID 
- (2) Parts No. F
- (3) Lot No. 

① Production Year

② Production Month (1,2,3,...9,O,N,D)

Flux may expand on PCB and attach onto the area where the marking is printed with laser.
In the case the marking become darker in color since flux is unreflecting.
It may be a little hard to read, however, the marking is not deleted nor blurred.

Note:

1. This datasheet is downloaded from the website of Murata Manufacturing co., Ltd. Therefore, it's specifications are subject to change or our products in it may be discontinued without advance notice. Please check with our sales representatives or product engineers before ordering.
2. This datasheet has only typical specifications because there is no space for detailed specifications. Therefore, please approve our product specifications or transact the approval sheet for product specifications before ordering.

Pin Number and Function

Pin No.	Symbol	Function
1	VAR	Vout Adjustment
2	FT	Output Trim
3,9,10,11	GND	GND
4,5	Vout	Output
6	+Sense	Output +Sense
7,8	Vin	Input Voltage
12	ON/OFF	Remote ON/OFF

3. Block Diagram

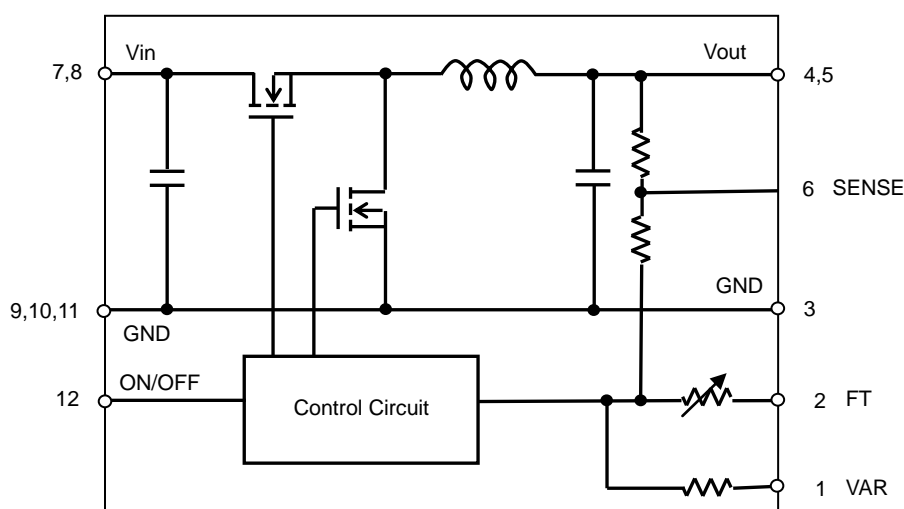

4. Environmental Conditions

4.1 Operating Temperature Range	-40°C ~ +85°C
4.2 Storage Temperature Range	-40°C ~ +85°C
4.3 Operating Humidity Range	20% ~ 85% (No water condenses in any cases.)
4.4 Storage Humidity Range	10% ~ 90% (No water condenses in any cases.)

5. Absolute Maximum Rating

Item	Unit	Absolute Rating	Remarks
Input Voltage Range	V	-0.3V~6.3V	
VAR Pin, ON/OFF Pin Voltage Range	V	-0.3V~Vin+0.3V	

※No voltage, no matter how instantaneous, shall be applied beyond the absolute maximum voltage rating to this product. If you apply any voltage over this limit the product characteristics will deteriorate or the product itself will be destroyed. Even though it may continue operating for a while after the over-voltage event, its life will likely be shortened significantly. Reliability and life of the module may degrade similarly if the maximum operating voltage rating is continuously exceeded. This product is designed to operate within the maximum operating voltage rating specification.

 **Note:**

- This datasheet is downloaded from the website of Murata Manufacturing co., ltd. Therefore, it's specifications are subject to change or our products in it may be discontinued without advance notice. Please check with our sales representatives or product engineers before ordering.
- This datasheet has only typical specifications because there is no space for detailed specifications. Therefore, please approve our product specifications or transact the approval sheet for product specifications before ordering.

6. Characteristics

6. 1 Electrical Characteristics (Ta=25 °C)

Item	Symbol	Condition	Value			Unit	
			Min.	Typ.	Max.		
Input Voltage Range	Vin		4.5	5.0	5.5	V	
UVLO Threshold	UVLO		-	4.3	-	V	
Output Voltage Adjustable Range	Vout		0.8	-	3.3	V	
Output Voltage Tolerance	Vo tol	Vin=4.5~5.5V Iout=0~4A	Vout=0.8~0.9V FT=Open	-2.0	-	+2.0	%Vo
			Vout=0.9~1.8V FT=Short	-1.5	-	+1.5	
			Vout=1.8~3.3V FT=Short	-2.0	-	+2.0	
Output Current	Iout	See the thermal derating curve in section 6.2.	0	-	4	A	
Ripple Voltage	Vrpl	Vin =4.5~5.5V, Iout=0~4A BW=20MHz	Vout=0.8~1.2V	-	15	30	mV(pp)
			Vout=1.2~3.3V	-	25	50	
Efficiency	EFF	Vin =5.0V, Iout=4A	Vout=1.2V	-	85	-	%
			Vout=2.5V	-	91	-	
			Vout=3.3V	-	93	-	
Operating Frequency	Frq		-	600	-	kHz	
ON/OFF pin High Voltage	VIH	ON/OFF pin is pulled up to Vin inside of the DC-DC converter. If ON/OFF pin is left open, the DC-DC converter shall be "ON". This pin will be pulled down to GND inside the DC-DC converter when UVLO events occur. Please do NOT connect this pin to power supply with low impedance line, so as not to damage the converter.					
ON/OFF pin Low Voltage	VIL	If ON/OFF pin is connected to GND, the DC-DC Converter shall be "OFF".	OFF	0	-	0.3	V
Short Circuit Protection	SCP	If output is shorted to GND , DC-DC converter shall be operated in a hiccup mode. After the short circuit event has cleared, the output is automatically brought back into regulation.		-	6.5	-	A
Additional Output Capacitor	Cout	When input voltage is ideal voltage source		47	-	1000	μF
Rising Overshoot	Vover			-	-	+10	%
Output Delay	Td	Output voltage 0-10% (remote on)		0.1	-	8	msec
Output Rise Time	Tr	Output voltage 10-90%		1	-	10	msec

※Caution

The above electrical characteristics are guaranteed with the condition that the impedance of the input voltage source is sufficiently low as shown in section 9. Connecting an input inductance or using an input power supply with output inductance may cause an unstable operation of this device. Please check the proper operation of this device with the peripheral circuits on your system.

It is strongly recommended that on/off terminal should be used when you turn on/off this product.

Characteristics may be affected by turning input voltage on/off. Please check product operation on your application with turning input voltage on/off.

⚠ Note:

- This datasheet is downloaded from the website of Murata Manufacturing co., ltd. Therefore, it's specifications are subject to change or our products in it may be discontinued without advance notice. Please check with our sales representatives or product engineers before ordering.
- This datasheet has only typical specifications because there is no space for detailed specifications. Therefore, please approve our product specifications or transact the approval sheet for product specifications before ordering.

6. 2 Thermal Derating

MPDTY321S
 (Vin=4.5~5.5V, Vout=0.8~3.3V,
 Air Flow: 0~0.2m/s)

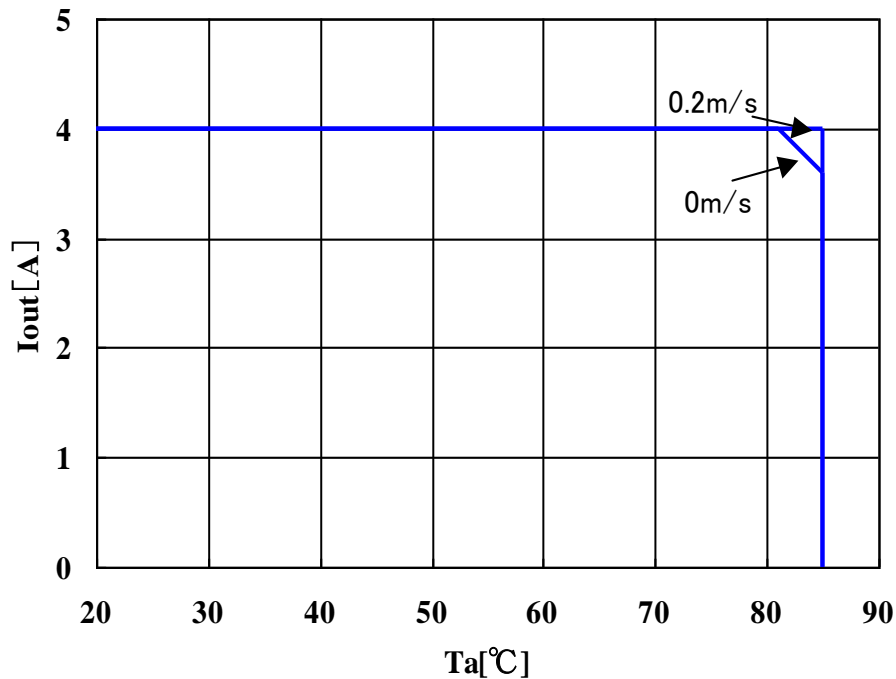

The above derating limits apply to this product soldered directly to 101.6*180mm*1.6mm PCB (double-sided, with 70um copper). Any adjacent parts of high temperature may cause overheating. For reliable operation, please ensure that the FET temperature of this product is maintained below 120°C and the inductor temperature is below 106°C.

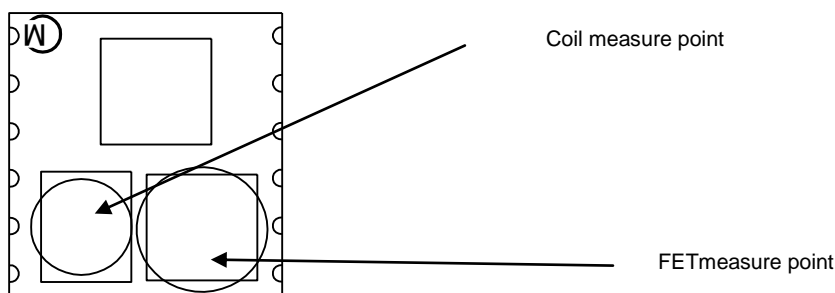

Note:

1. This datasheet is downloaded from the website of Murata Manufacturing co., ltd. Therefore, it's specifications are subject to change or our products in it may be discontinued without advance notice. Please check with our sales representatives or product engineers before ordering.
2. This datasheet has only typical specifications because there is no space for detailed specifications. Therefore, please approve our product specifications or transact the approval sheet for product specifications before ordering.

7. Operation in information

7.1 Output Voltage Adjustment

The output voltage can be adjusted ranging from 0.8V to 3.3 V by connecting resistors between VAR-pin(1pin) to GND-pin.

The following equation gives the required external-resistor value to adjust the output voltage to V_{oadj} . It is strictly recommended to evaluate the characteristics of DC-DC converter at your board conditions.

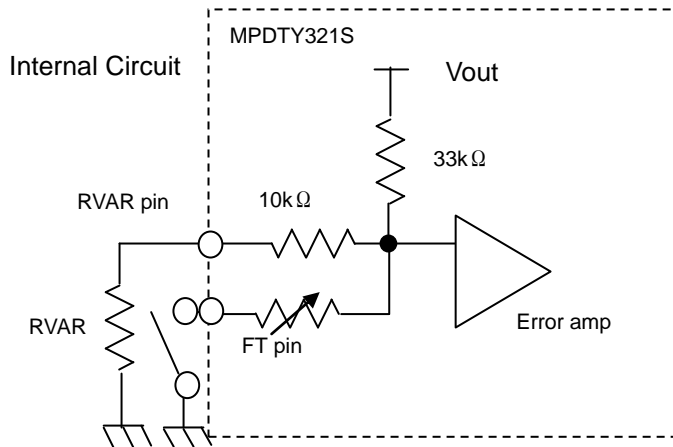

(a) $0.8 \leq V_{out} < 0.9V$ (FT-pin : OPEN)

$$RVAR = \frac{26400}{V_{oadj}[V] - 0.8[V]} - 10000 \quad [\Omega]$$

(b) $0.9 \leq V_{out} \leq 3.3V$ (FT-pin : SHORT to GND)

$$RVAR = \frac{26400}{V_{oadj}[V] - 0.9[V]} - 10000 \quad [\Omega]$$

<RVAR Calculation Example>

Vo-adj [V]	Calculated RVAR[Ω]	RVAR Example	FT pin
3.3	1000	1.0kΩ	Short to GND
2.5	6500	4.3kΩ + 2.2kΩ	Short to GND
2.0	14000	13kΩ + 1kΩ	Short to GND
1.8	19333	18kΩ + 1.3kΩ	Short to GND
1.5	34000	33kΩ + 1kΩ	Short to GND
1.2	78000	7.5kΩ + 3kΩ	Short to GND
1.1	122000	120kΩ + 2kΩ	Short to GND
0.9	Open	Open	Short to GND
0.8	Open	Open	Open

7.2 ON/OFF control

ON/OFF function

Using the ON/OFF feature, the operation of this product can be disabled without removal of the input voltage.

Internal Circuit

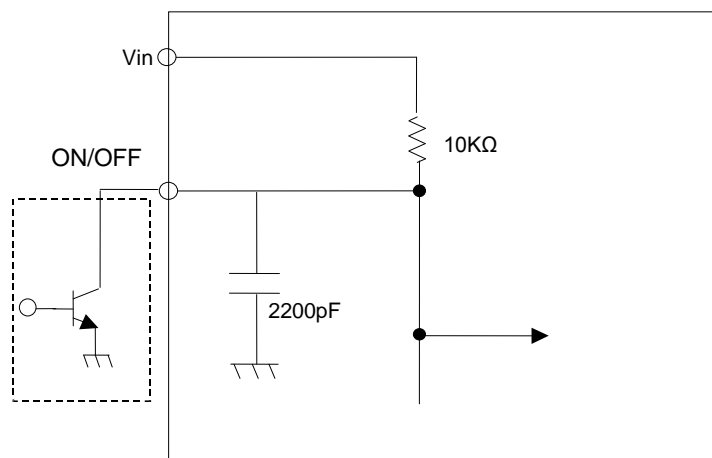

⚠ Note:

- This datasheet is downloaded from the website of Murata Manufacturing co., ltd. Therefore, it's specifications are subject to change or our products in it may be discontinued without advance notice. Please check with our sales representatives or product engineers before ordering.
- This datasheet has only typical specifications because there is no space for detailed specifications. Therefore, please approve our product specifications or transact the approval sheet for product specifications before ordering.

ON/OFF Control Operation

When ON/OFF-pin(12pin) is left open

When ON/OFF-pin(12pin) is connected to GND

..... Output Voltage =ON

..... Output Voltage=OFF

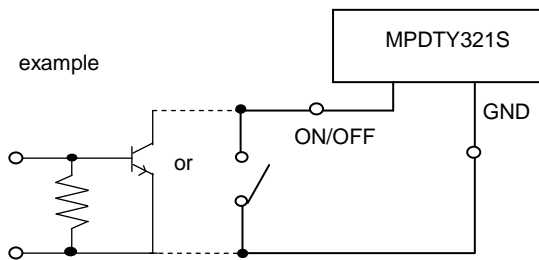
**< Caution >**

ON/OFF pin is pulled up inside of the DC-DC converter, so voltage appears up to V_{in} at ON/OFF pin.

ON/OFF pin will be pulled down to GND inside the DC-DC converter when UVLO events occur.

Please do NOT connect this pin to power supply, so as not to damage the converter.

ON/OFF pin of MPDTY321S can be connected each other. The maximum number is up to 20pcs.

7. 3. Parallel Operation.

This product is incapable of parallel operation

7. 4. Output voltage sensing

By connecting SENSE-pin to the load, output voltage drop in wiring shall be compensated.

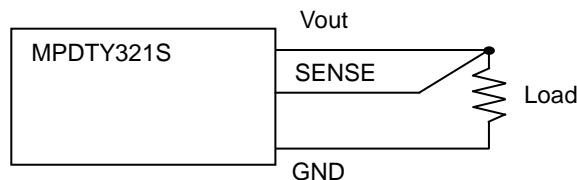

Please do NOT connect SENSE-pin to the output of LC filter that is set to the Vout line. When using this way, this product will not operate properly.

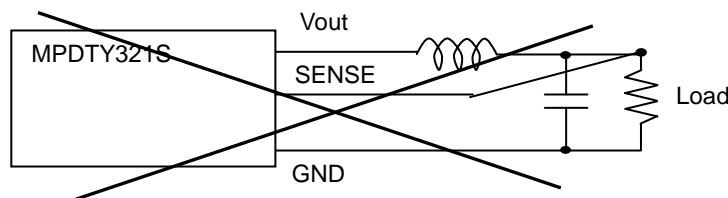
**※Caution**

Please connect SENSE-pin to Vout-pin nearby the product, if sense function is not used.

7. 5. External Output Bias Condition

External bias voltage level. Less than V_{oadj}

External bias current level. Less than DC7A

External output bias measurement condition

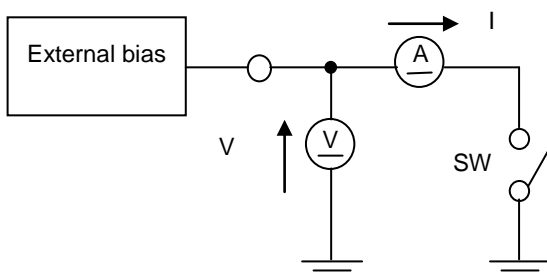

External bias voltage shall be measured when SW left open.

External bias current shall be measured when SW left short.

⚠ Note:

1. This datasheet is downloaded from the website of Murata Manufacturing co., ltd. Therefore, it's specifications are subject to change or our products in it may be discontinued without advance notice. Please check with our sales representatives or product engineers before ordering.
2. This datasheet has only typical specifications because there is no space for detailed specifications. Therefore, please approve our product specifications or transact the approval sheet for product specifications before ordering.

7. 6. Input External capacitor

It is recommended to connect a low-impedance electrolytic capacitor of 22 μ F or more at Vin terminal. Smaller input capacitor may leads to an unstable operation of this product caused by input voltage fluctuation. Please check the proper operation of it on your product when smaller input capacitor is used.

Using ceramic capacitors as input capacitor may cause an increase of output voltage, because input ripple current flows through the external input capacitor and wiring resistance. This phenomenon is affected by the position of external capacitors, the value of external capacitors and voltage difference between Vin and Vout. Using low-impedance electrolytic capacitor will ease this problem. Please check the proper operation of it on your product when ceramic input capacitor is used.

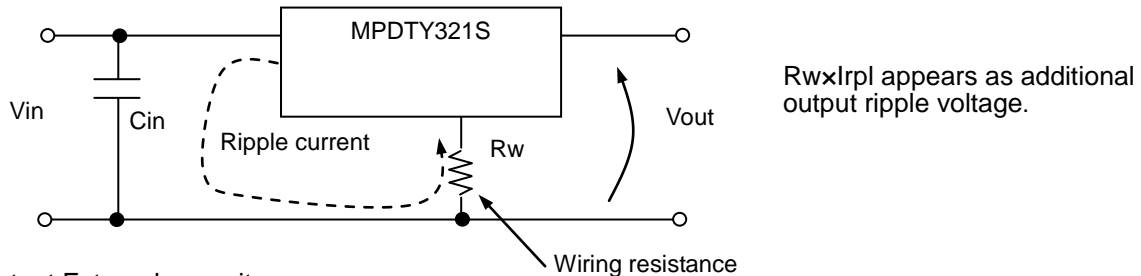

7. 7. Output External capacitor

Ceramic capacitors are recommended as output external capacitor. Using ceramic capacitors, small output variation and small ripple voltage are realized.

Output capacitor should be within 47 μ F to 1000 μ F. Output capacitor shall be placed near the output terminal. When using plural capacitors, please make sure to place a capacitor of at least 47 μ F near the output terminal, and place other capacitors near the load.

When using LC output filter, please make sure to place a capacitor of at least 47 μ F near the output terminal.

8. Reliability

8.1 Humidity

According to JIS-C-0022.

40 \pm 2 $^{\circ}$ C, 90 to 95%RH, 100 hours. Leave for 4 hours at room temperature.

No damage in appearance and no deviation from electrical characteristics (section 6.1.).

8.2 Temperature Cycles

Repeat cycle 5 times. Leave 2 hours at room temp.

No damage in appearance and no deviation from electrical characteristics (section 6.1.).

Step	Condition	Time
1	-40 $^{\circ}$ C \pm 3 $^{\circ}$ C	30 minutes
2	Room Temp.	5-10 minutes
3	+85 $^{\circ}$ C \pm 2 $^{\circ}$ C	30 minutes
4	Room Temp.	5-10 minutes

8.3 Vibration

10 to 55Hz, 1.5mm amplitude (1minute cycle), 1 hour for each of X, Y, Z directions.

No damage in appearance and no deviation from electrical characteristics (section 6.1.).

8.4 Mechanical Shock

20G, 1 time for each X, Y, Z directions.

No damage in appearance and no deviation from electrical characteristics (section 6.1.).

8.5 Solderability of Leads

The side through-hole terminal will be immersed in the isopropyl alcohol (JIS-K-1522) with Rosin (JIS-K-5902) solution (the concentration of Rosin will be allowed 10wt%~35wt%, and normally approx. 25wt% will be used without any specific requirement.).

Then the terminal will be immersed in the solder H63A (JIS-Z-3282) solution at the temperature of 230 $^{\circ}$ C \pm 5 $^{\circ}$ C for 5 \pm 1 seconds, and pulled up completely. The solder will adhere to over three-quarter of the terminal.

Note:

- This datasheet is downloaded from the website of Murata Manufacturing co., ltd. Therefore, it's specifications are subject to change or our products in it may be discontinued without advance notice. Please check with our sales representatives or product engineers before ordering.
- This datasheet has only typical specifications because there is no space for detailed specifications. Therefore, please approve our product specifications or transact the approval sheet for product specifications before ordering.

9. Test Circuit

In the following test circuit, the initial values under item 6.1. should be met.

9.1. General Measure Circuit

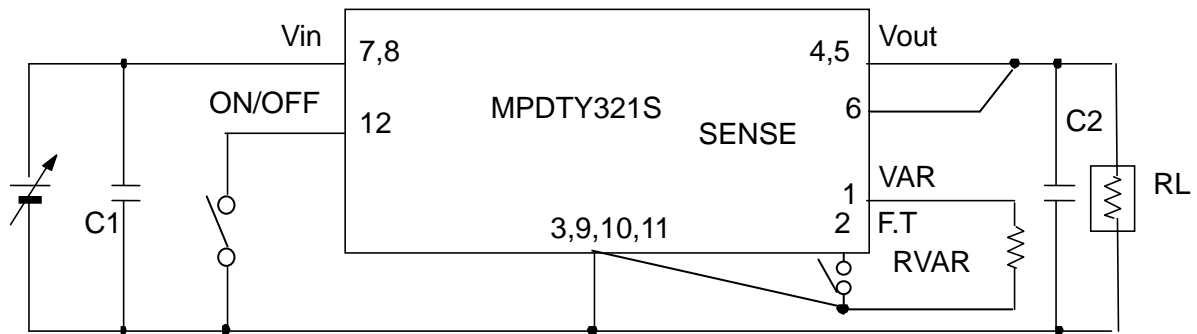

C1 : 22 μ F/10V Ceramic Capacitor

C2 : 47 μ F/6.3V Ceramic Capacitor

Please make sure to place C1 and C2 nearby input and output terminal of DC-DC converter.

It is strongly recommended that on/off terminal should be used when you turn on/off this product. Characteristics may be affected by turning input voltage on/off. Please check product operation on your application with turning input voltage on/off.

9.2. Ripple Voltage Measurement Circuit

Coaxial cable :1.5D-2V, L=1.5m

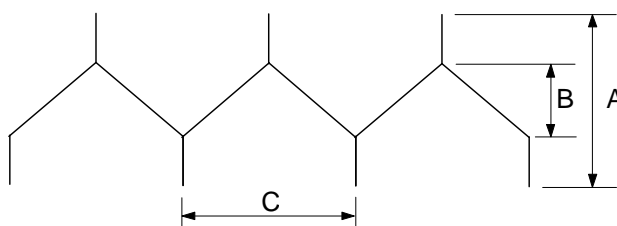
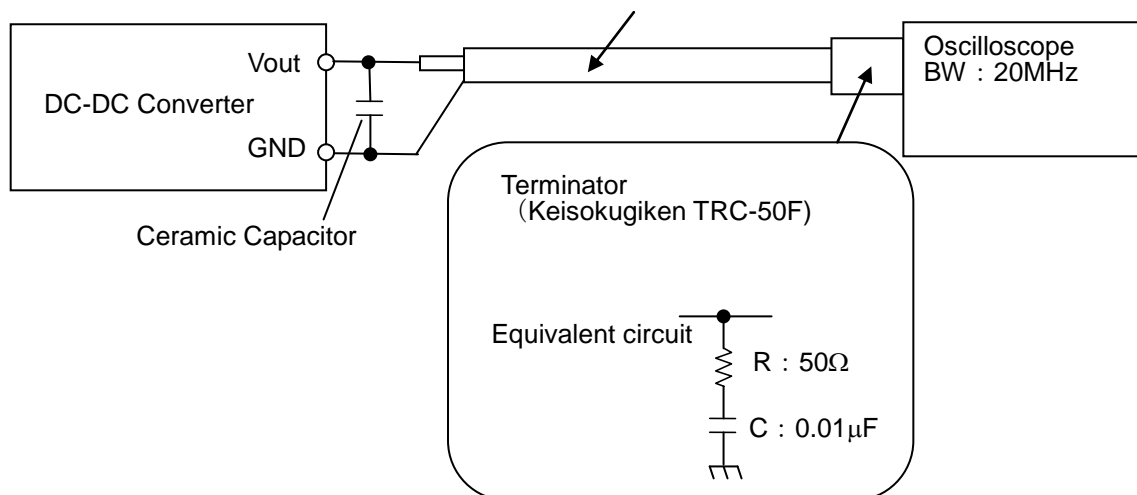

A Ripple Noise Voltage

:

B Ripple Voltage

:

C Switching Period

Note:

1. This datasheet is downloaded from the website of Murata Manufacturing co., ltd. Therefore, it's specifications are subject to change or our products in it may be discontinued without advance notice. Please check with our sales representatives or product engineers before ordering.
2. This datasheet has only typical specifications because there is no space for detailed specifications. Therefore, please approve our product specifications or transact the approval sheet for product specifications before ordering.

10. Packaging Specification

10.1. Tray Dimensions

DC-DC converter are put the trays. (See Fig.1)

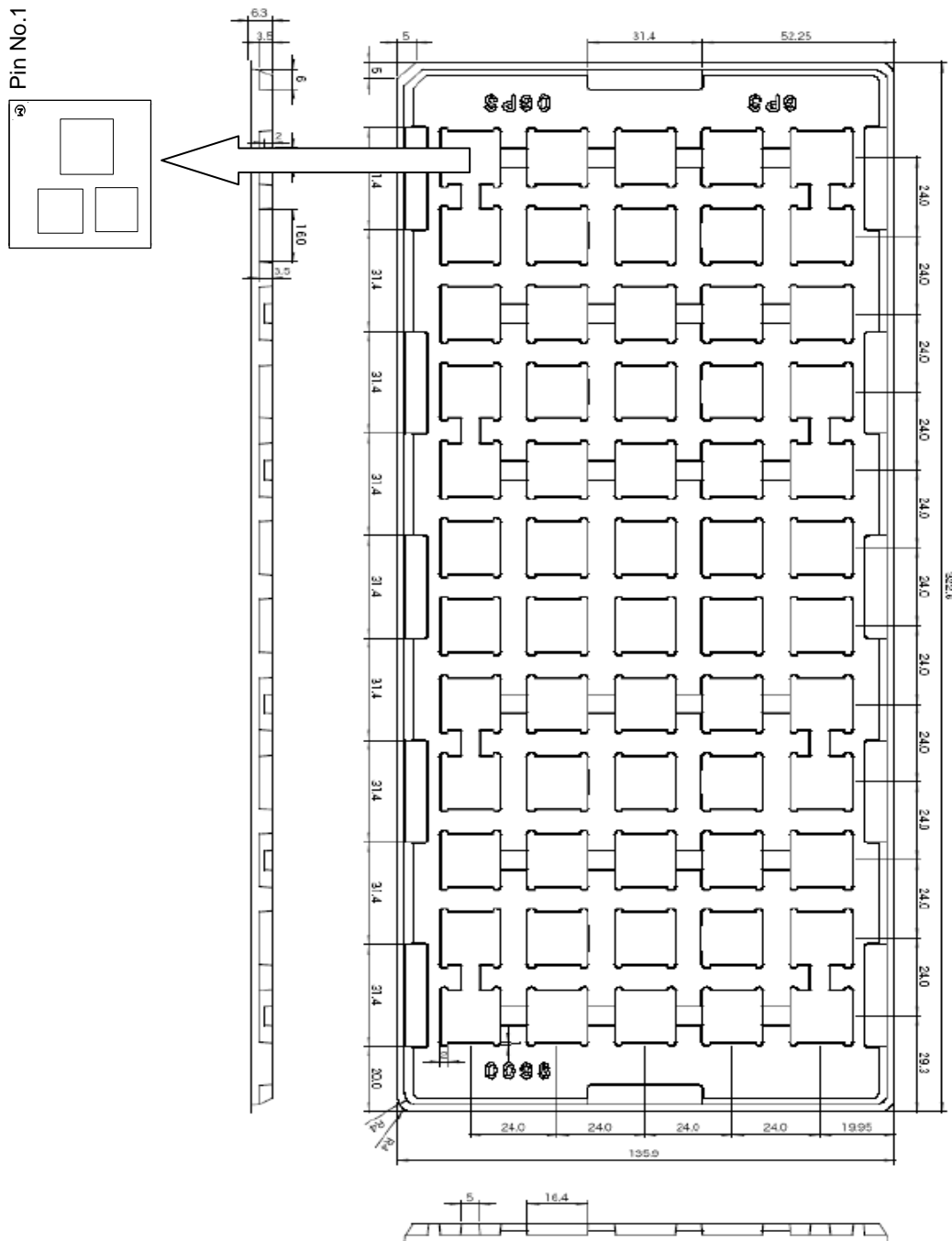

Fig.1

Note:

1. This datasheet is downloaded from the website of Murata Manufacturing co., ltd. Therefore, it's specifications are subject to change or our products in it may be discontinued without advance notice. Please check with our sales representatives or product engineers before ordering.
2. This datasheet has only typical specifications because there is no space for detailed specifications. Therefore, please approve our product specifications or transact the approval sheet for product specifications before ordering.

10.2. Contained pieces of products per corrugated box.

Maximum contained products pieces 600pcs./corrugated box

Further plural sheets of corrugated cardboard are placed on the top of the dummy tray according to number of contained trays in order to full up the space in a corrugated box.

10.3. Packaging Form

Trays with products are lidded and packed in a corrugated box. (See Fig.2)

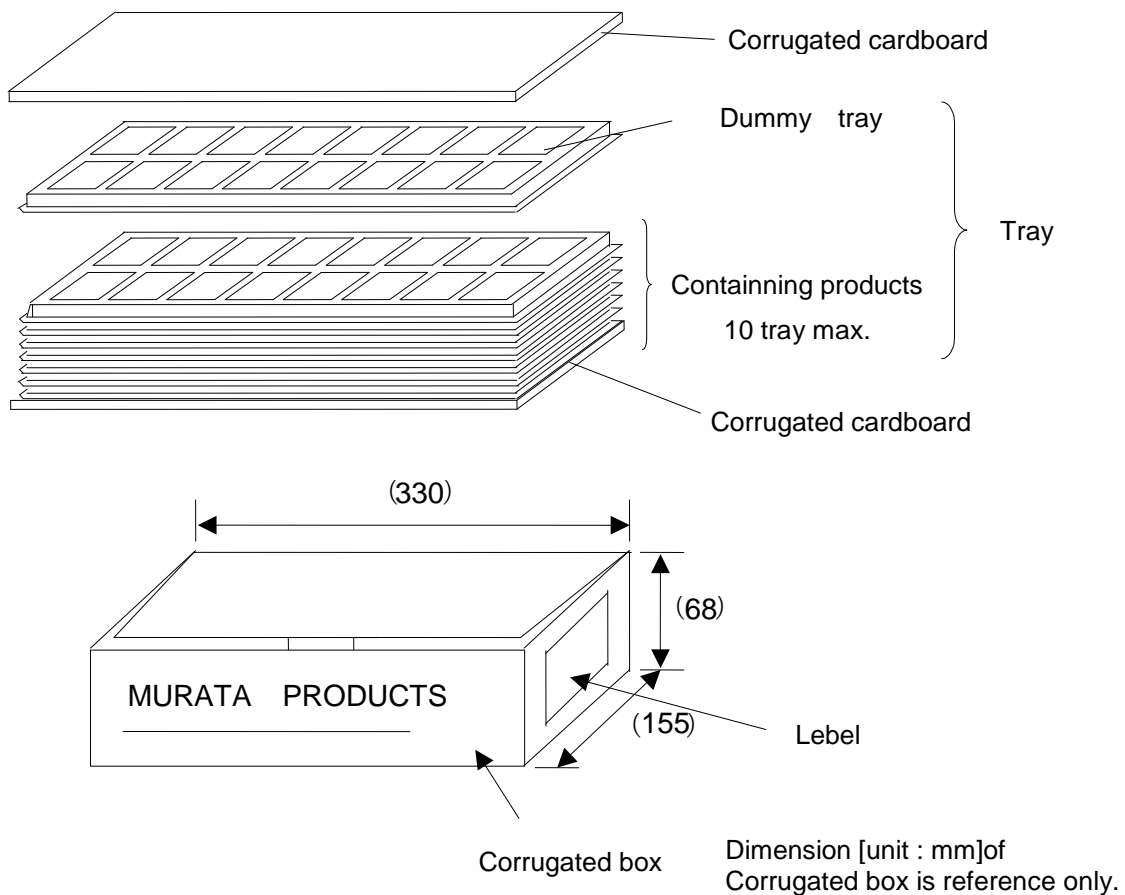

Fig.2

※Marking on the box

1.Murata Parts No. 2.Quantity 3.Inspection No. 4.RoHS-Y<*>

11. Production factory

Komatsu Murata Mfg.Co., Ltd.
Kanazu Murata Mfg. Co., Ltd.
Wakura Murata Mfg. Co., Ltd.

⚠ Note:

1. This datasheet is downloaded from the website of Murata Manufacturing co., ltd. Therefore, it's specifications are subject to change or our products in it may be discontinued without advance notice. Please check with our sales representatives or product engineers before ordering.
2. This datasheet has only typical specifications because there is no space for detailed specifications. Therefore, please approve our product specifications or transact the approval sheet for product specifications before ordering.

12. Typical Characteristics Data

12.1 Load Transient Response

$V_{in}=5.0V$, $V_o=2.5V$

$I_o=2A \rightarrow 4A$, $di/dt=2.5A/\mu s$, $C_{out}=0 \mu F$, $2000\mu F$ (Ceramic), $T_a=25^\circ C$

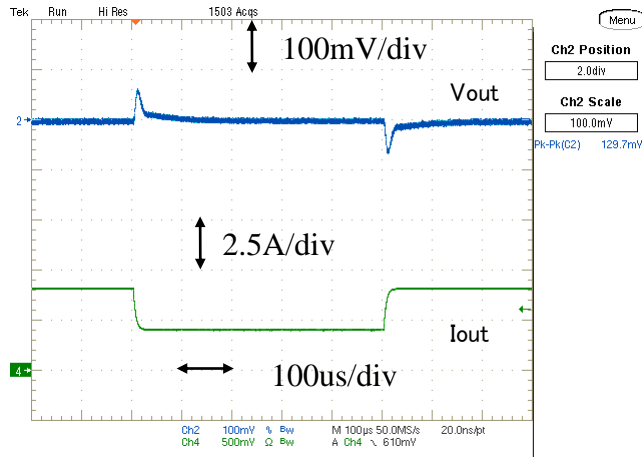

Fig. 12-1a. Load Transient Response (C_{out} : $0\mu F$)

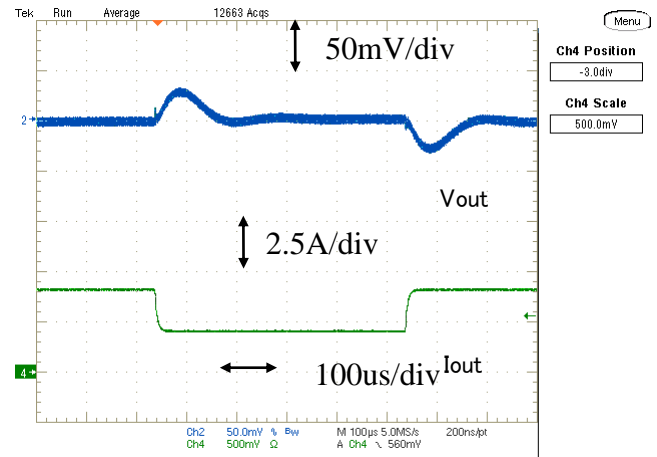

Fig. 12-1b. Load Transient Response (C_{out} : $2000\mu F$)

Note:

1. This datasheet is downloaded from the website of Murata Manufacturing co., ltd. Therefore, it's specifications are subject to change or our products in it may be discontinued without advance notice. Please check with our sales representatives or product engineers before ordering.
2. This datasheet has only typical specifications because there is no space for detailed specifications. Therefore, please approve our product specifications or transact the approval sheet for product specifications before ordering.

12.2. Other electrical characteristics

12.2.1. $V_{out}=3.3V$

(Ta=25 °C, Cin= GRM32DR71E106KA12L*2, Cout=GRM32EC80J476ME64L, Rtrim=1000Ω)

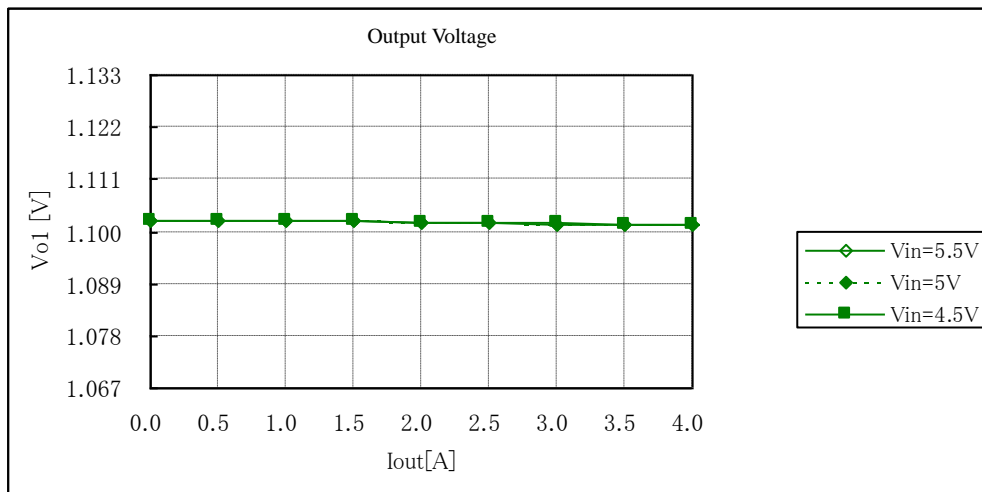

Fig. 12-2-1. Output Voltage v.s. Output Current

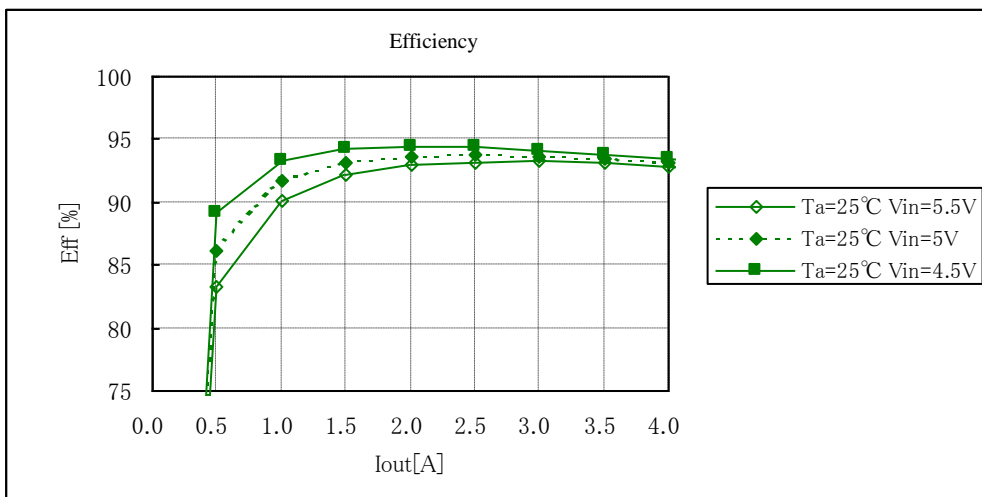

Fig. 12-2-2. Efficiency v. s. Output Current

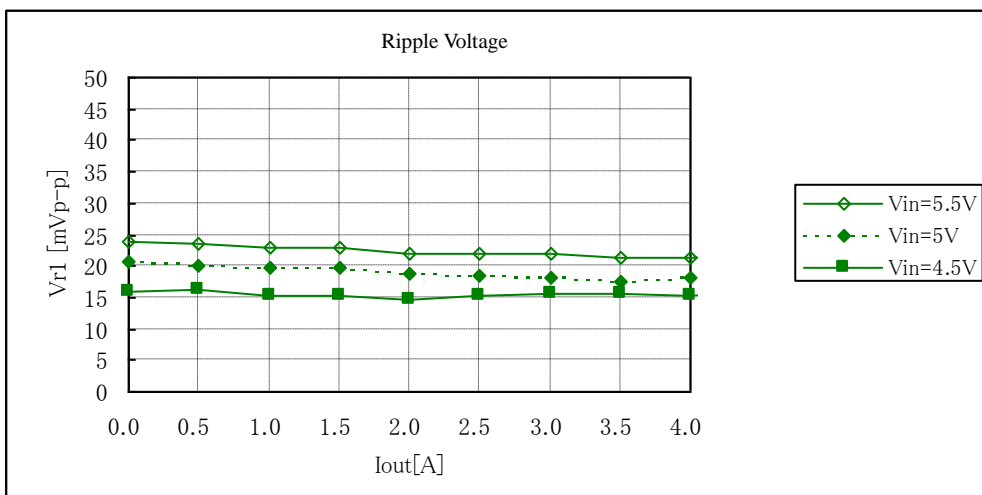

Fig. 12-2-3. Ripple Voltage v. s. Output Current

⚠ Note:

1. This datasheet is downloaded from the website of Murata Manufacturing co., ltd. Therefore, it's specifications are subject to change or our products in it may be discontinued without advance notice. Please check with our sales representatives or product engineers before ordering.
2. This datasheet has only typical specifications because there is no space for detailed specifications. Therefore, please approve our product specifications or transact the approval sheet for product specifications before ordering.

12.2.2. $V_{out}=2.5V$

($T_a=25^\circ C$, $C_{in}=GRM32DR71E106KA12L*2$, $C_{out}=GRM32EC80J476ME64L$, $R_{trim}=6500\Omega$)

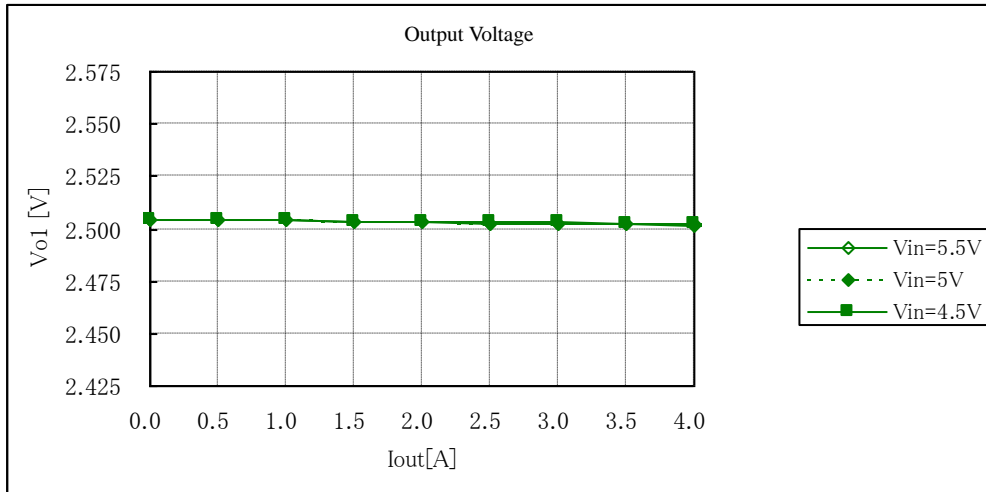

Fig. 12-2-4. Output Voltage v.s. Output Current

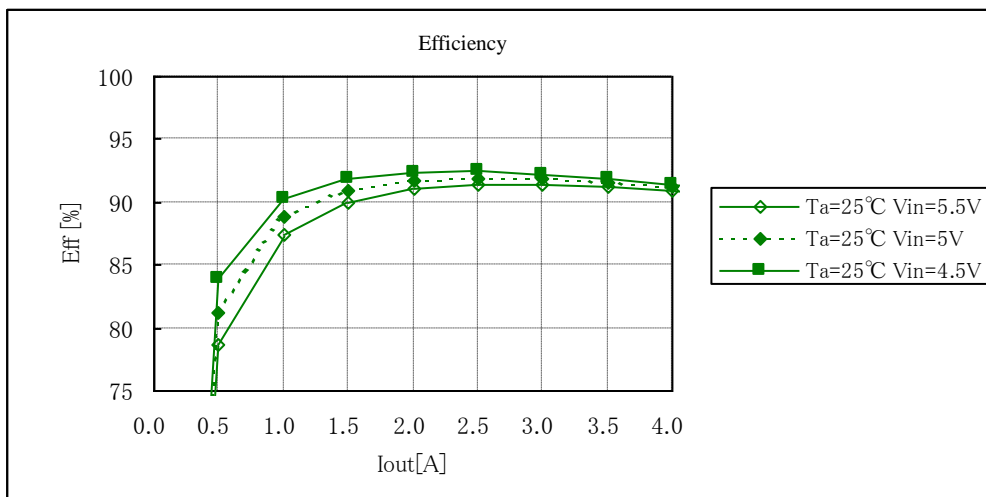

Fig. 12-2-5. Efficiency v. s. Output Current

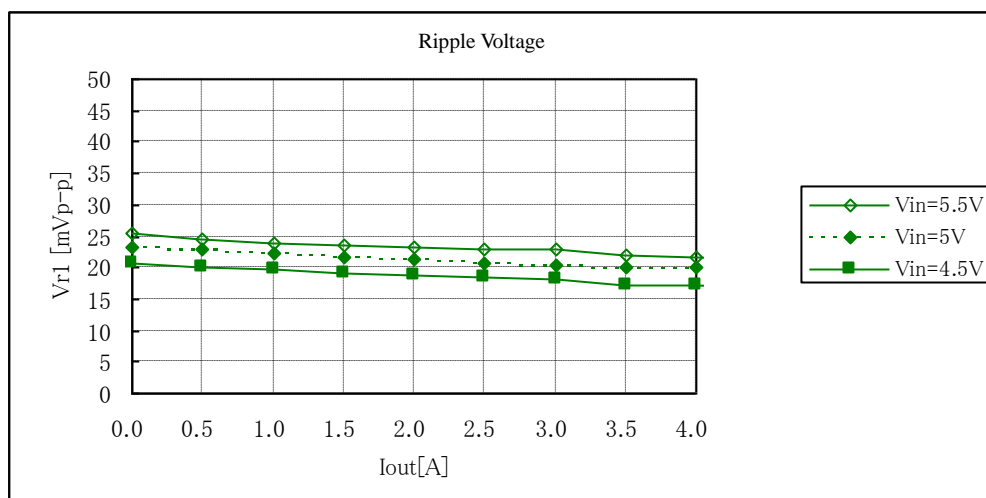

Fig. 12-2-6. Ripple Voltage v. s. Output Current

Note:

1. This datasheet is downloaded from the website of Murata Manufacturing co., ltd. Therefore, it's specifications are subject to change or our products in it may be discontinued without advance notice. Please check with our sales representatives or product engineers before ordering.
2. This datasheet has only typical specifications because there is no space for detailed specifications. Therefore, please approve our product specifications or transact the approval sheet for product specifications before ordering.

12.2.3. $V_{out}=1.1V$

($T_a=25^\circ C$, $C_{in}=GRM32DR71E106KA12L*2$, $C_{out}=GRM32EC80J476ME64L$, $R_{trim}=122000\Omega$)

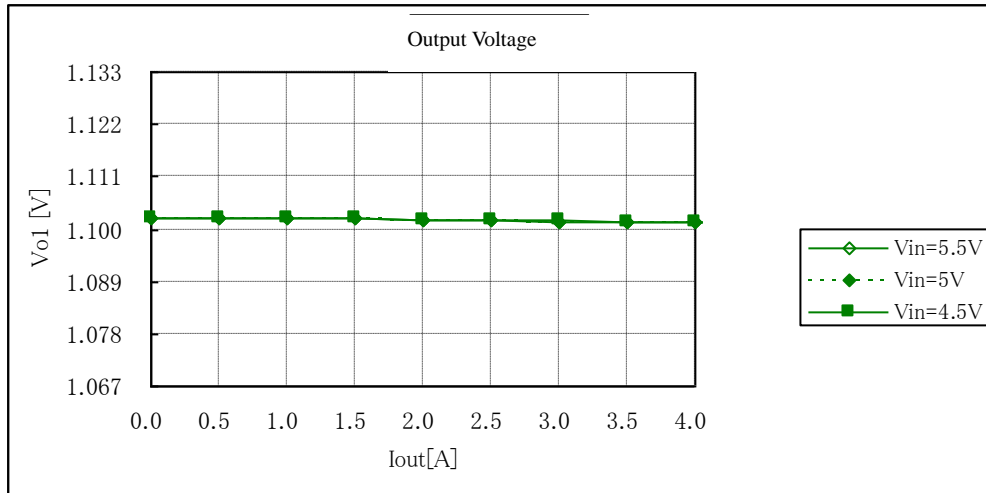

Fig. 12-2-7. Output Voltage v.s. Output Current

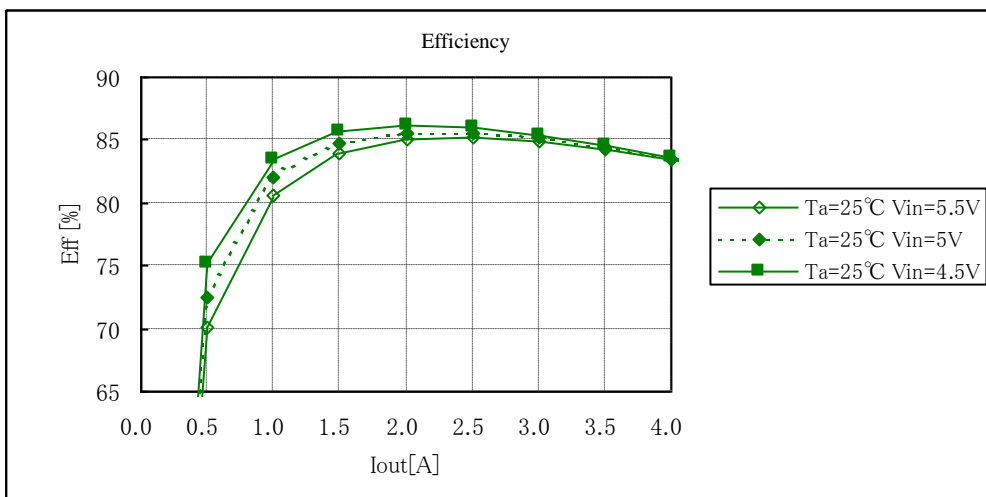

Fig. 12-2-8. Efficiency v. s. Output Current

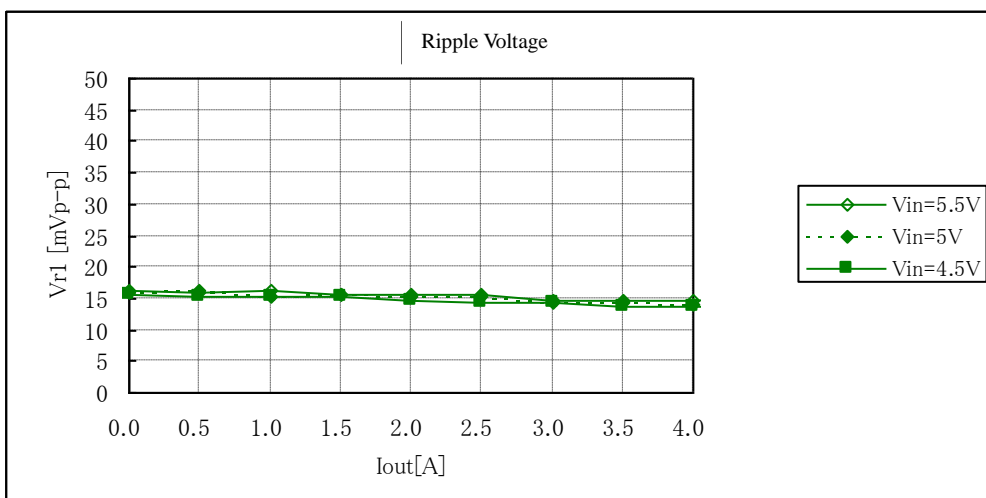

Fig. 12-2-9. Ripple Voltage v. s. Output Current

Note:

1. This datasheet is downloaded from the website of Murata Manufacturing co., ltd. Therefore, it's specifications are subject to change or our products in it may be discontinued without advance notice. Please check with our sales representatives or product engineers before ordering.
2. This datasheet has only typical specifications because there is no space for detailed specifications. Therefore, please approve our product specifications or transact the approval sheet for product specifications before ordering.

12.2.4 $V_{out}=0.8V$

(Ta=25 °C, Cin= GRM32DR71E106KA12L*2, Cout=GRM32EC80J476ME64L, Rtrim=Open)

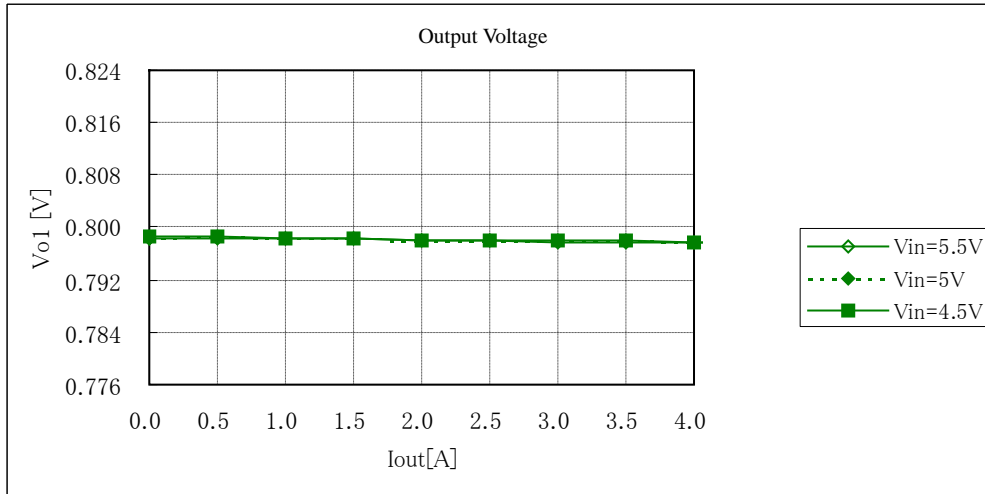

Fig. 12-2-10. Output Voltage v.s. Output Current

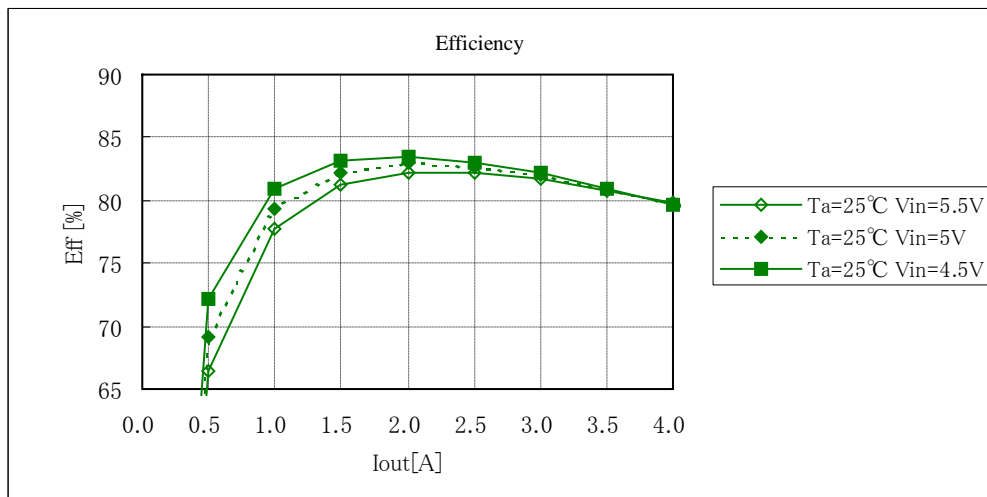

Fig. 12-2-11. Efficiency v. s. Output Current

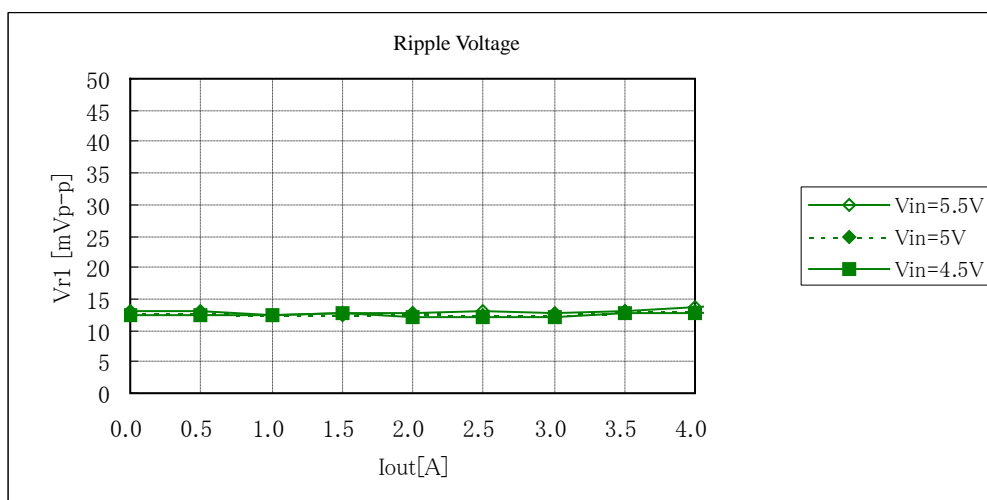

Fig. 12-2-12. Ripple Voltage v. s. Output Current

⚠ Note:

1. This datasheet is downloaded from the website of Murata Manufacturing co., ltd. Therefore, it's specifications are subject to change or our products in it may be discontinued without advance notice. Please check with our sales representatives or product engineers before ordering.
2. This datasheet has only typical specifications because there is no space for detailed specifications. Therefore, please approve our product specifications or transact the approval sheet for product specifications before ordering.

13. Mounting Condition

13.1. PCB Land Pattern Recommendation

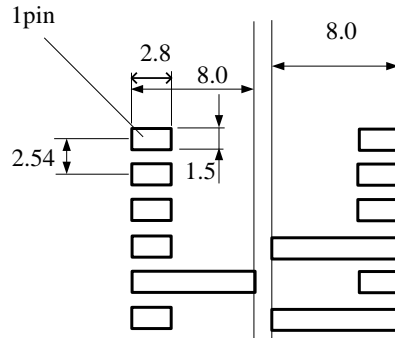

There are wiring coppers or through-hole via at the bottom side of the DC-DC converter. When you design your PCBs, please be careful not to short the circuit of the DC-DC converter or PCBs.

13.2. Recommended Soldering Conditions

Reflow Soldering

This product is RoHS compliant. The following profile is recommended for the reflow of this product using Pb-free solder paste (Sn-Ag-Cu).

Method : Full convection reflow soldering

Reflow Soldering Profile

JEDEC IPC/JEDEC J-STD-020D
Table 5-2 Classification Reflow Profile
Pb-Free Assembly Large Body

Profile details

Soldering temperature : 245°C+0/-5°C
Soldering time : 30 seconds, 240 to 245°C
Heating time : 60 to 150 seconds, over 217°C
Preheating time : 60 to 120 seconds, 150 to 200°C
Programming rate : 3°C/ sec. Max., 217 to 245°C
Descending rate : 6°C/ sec. Max.
Total soldering time : 8 minutes Max., 25 to 245°C
Times : 1 time

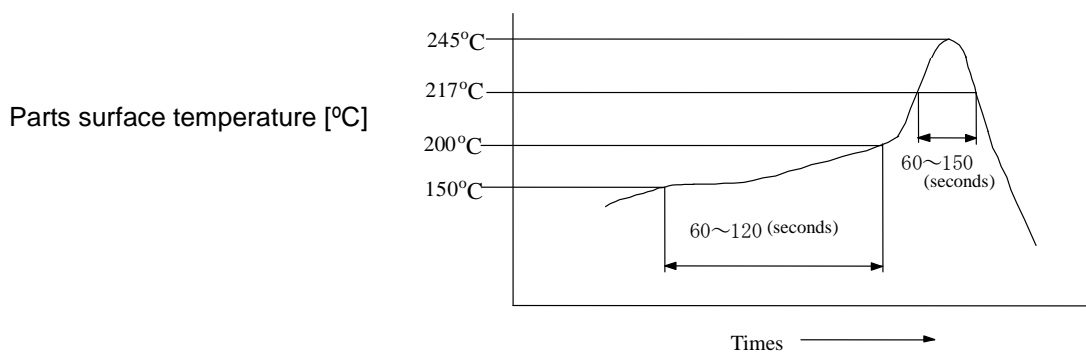

※Do not vibrate for the products on reflow.

Please need to take care temperature control because mounted parts may come off if the product are left under the high temperature.

Do not reflow DC-DC converter as follows, because DC-DC converter may fall down from a substrate during reflowing.

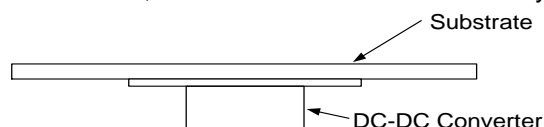

Note:

1. This datasheet is downloaded from the website of Murata Manufacturing co., ltd. Therefore, it's specifications are subject to change or our products in it may be discontinued without advance notice. Please check with our sales representatives or product engineers before ordering.
2. This datasheet has only typical specifications because there is no space for detailed specifications. Therefore, please approve our product specifications or transact the approval sheet for product specifications before ordering.

14. Notice

- 14.1. Both input-side and output side, please make the wiring loop between plus and minus as small as possible. The influence of a leakage inductance can be reduced.
- 14.2. Please make the power line pattern as wide and short as possible. The Following figure is an example of recommendable PCB design.

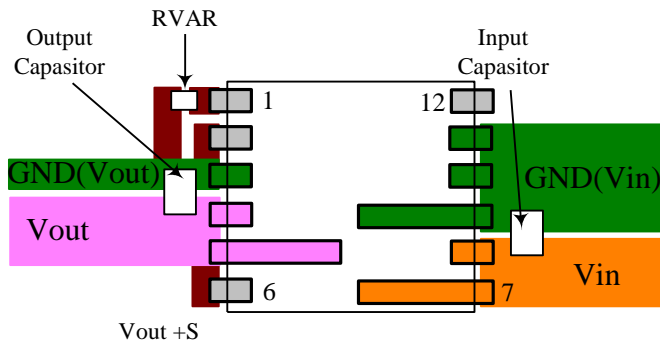

- 14.3. This product should not be operated in parallel or in series.
- 14.4. Please do not use a connector or a socket to connect this product to your product. The electric characteristics may be deteriorated by the influence of contact resistance.
- 14.5. Be sure to provide an appropriate fail-safe function on your product to prevent secondary damage that may be caused due to abnormal functional or failure of this product.
- 14.6. Inrush current protection is not a feature of this product.
- 14.7. Please connect the input terminals with the correct polarity. If an error in polarity connection is made this product may be damaged. If this product is damaged internally, an elevated input current may flow, and so this product may exhibit an abnormal temperature rise, or your product may be damaged. Please add a diode and fuse per the following diagram to protect them.

※Please select diode and fuse after confirming the operation of your product.

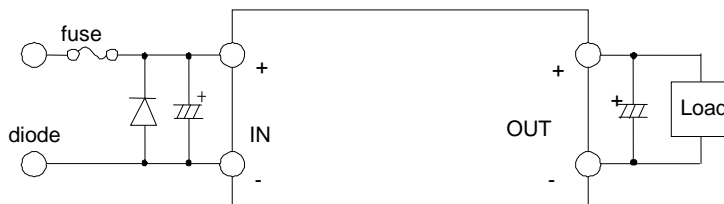

- 14.8. Cleaning
Please use no-cleaning type flux and do not wash this product.

14.9. Storage

- 14.9.1. Please store the products in room where the temperature/humidity is stable and direct sunlight cannot come in, and use the products within 6 months after delivery. Please avoid damp and heat or such places where the temperature greatly changes, as water may condense on this product, and the quality of characteristics may be reduced, and/or be the solderability may be degraded.

If this product needs to be stored for a long time (more than 1 year), this product may be degraded in solderability and/or corroded. Please test the solderability of this product regularly. Baking before reflow process is unnecessary to store the products under 30°C, 60%RH or less up to 6 months. In case the storage condition is over above mentioned, if these are unpacked condition, please bake them at 125°C ± 5°C/24hour. If these are packed in a tape, please bake them before soldering at 60°C ± 5°C/168hour.

- 14.9.2. Please do not store this product in places such as :
A dusty place, a place exposed directly to sea breeze, or in an atmosphere containing corrosive gas (Cl₂, NH₃, SO₂, NO_x and so on).

 **Note:**

- This datasheet is downloaded from the website of Murata Manufacturing co., ltd. Therefore, it's specifications are subject to change or our products in it may be discontinued without advance notice. Please check with our sales representatives or product engineers before ordering.
- This datasheet has only typical specifications because there is no space for detailed specifications. Therefore, please approve our product specifications or transact the approval sheet for product specifications before ordering.

14. 10. Operational Environment and Operational Conditions

14.10.1 Operational Environment

The products are not waterproof, chemical-proof or rust-proof.

In order to prevent leakage of electricity and abnormal temperature increase of the products, do not use the products under the following circumstances:

- (1) in an atmosphere containing corrosive gas (Cl₂, NH₃, SO₂, NOX and so on).
- (2) in a dusty place.
- (3) in a place exposed to direct sunlight.
- (4) in such a place where water splashes or in such a humid place where water condenses.
- (5) in a place exposed to sea breeze.
- (6) in any other places similar to the above (1)through (5).

14.10.2. Operational Conditions

Please use the products within specified values (power supply, temperature, input, output and load condition, and so on). Input voltage drop for line impedance, so please make sure that input voltage is included in specified values.

If you use the products over the specified values, it may break the products, reduce the quality, and even if the products can endure the condition for short time, it may cause degradation of the reliability.

Also please take care that the external voltage over output voltage of DC-DC Converter does not applies to output of this DC-DC Converter.

14.10.3. Note prior to use

If you apply high static electricity, over rated voltage or reverse voltage to the products, it may cause defects in the products or degrade the reliability.

Please avoid the following items:

- (1) over rating power supply, reverse power supply or not-enough connection of 0 V(DC) line.
- (2) electrostatic discharge by production line and/or operator.
- (3) electrified product by electrostatic induction.

Do not give an excessive mechanical shock..

If you drop the products on the floor, etc., it may occur a crack to the core of inductors and monolithic ceramic capacitors.

Do not give a strong shock such as a drop in handling.

14. 11. Transportation

If you transport the products, please pack them so that the package will not be damaged by mechanical vibration or mechanical shock, and please educate and guide a carrier to prevent rough handling.

If you transport the products to overseas (in particular, by sea), it is expected that the transportation environment will be the worst, so please pack the products, in the package designed on the consideration of mechanical strength, vibration-resistant and humidity-resistant. The package of the products which Murata sells in Japan, may not resist over seas transport.

Please consult us if you are to use the Murata package of the products sold in Japan for transport to overseas.

Note

1. Murata recommends that customers ensure that the evaluation and testing of these devices are completed with this product actually assembled on their product.
2. Please contact our main sales office or nearby sales office before using our products for the applications listed below which require especially high reliability for the prevention of defects which might directly cause damage to the third party's life, body or property or this products for any other applications that described in the above.

- ① Aircraft equipment
- ② Aerospace equipment
- ③ Undersea equipment
- ④ Power plant control equipment
- ⑤ Medical equipment
- ⑥ Transportation equipment (vehicles, trains, ships, etc.)
- ⑦ Traffic signal equipment
- ⑧ Disaster prevention /crime prevention equipment
- ⑨ Data-processing equipment
- ⑩ Application of similar complexity and/or reliability requirements to the applications listed in the above.

This DATA Sheet is indicated in Aug 2009. About the written contents, since changing without a preliminary announcement for improvement and supply are sometimes stopped, please confirm in case of ordering.

If written contents are unknown, please ask to our main sales office or nearby sales office.

Note:

1. This datasheet is downloaded from the website of Murata Manufacturing co., ltd. Therefore, it's specifications are subject to change or our products in it may be discontinued without advance notice. Please check with our sales representatives or product engineers before ordering.
2. This datasheet has only typical specifications because there is no space for detailed specifications. Therefore, please approve our product specifications or transact the approval sheet for product specifications before ordering.