

# NCP4413, NCP4414

## 3 A High-Speed MOSFET Drivers

The NCP4413/4414 are 3 A CMOS buffer/drivers. They will not latch up under any conditions within their power and voltage ratings. They are not subject to damage when up to 5 V of noise spiking of either polarity that occurs on the ground pin. They can accept, without damage or logic upset, up to 500 mA of current of either polarity being forced back into their output. All terminals are fully protected against up to 4 kV of electrostatic discharge.

As MOSFET drivers, the NCP4413/4414 can easily switch 1800 pF gate capacitance in 20 nsec with matched rise and fall times, and provide low enough impedance in both the ON and the OFF states to ensure the MOSFET's intended state will not be affected, even by large transients. The rise and fall time edges are matched to allow driving short-duration inputs with greater output accuracy.

### Features

- Latch-up Protected: Will Withstand 500 mA Reverse Current
- Input Will Withstand Negative Inputs Up to 5 V
- ESD Protected (4 kV)
- High Peak Output Current (3 A)
- Wide Operating Range (4.5 V to 16 V)
- High Capacitive Load Drive Capability (1800 pF in 20 nsec)
- Short Delay Time (35 nsec Typ)
- Consistent Delay Times with Changes in Supply Voltage
- Matched Delay Times
- Low Supply Current
  - With Logic "1" Input (500  $\mu$ A)
  - With Logic "0" Input (100  $\mu$ A)
- Low Output Impedance (2.7  $\Omega$ )

Functional Block Diagram

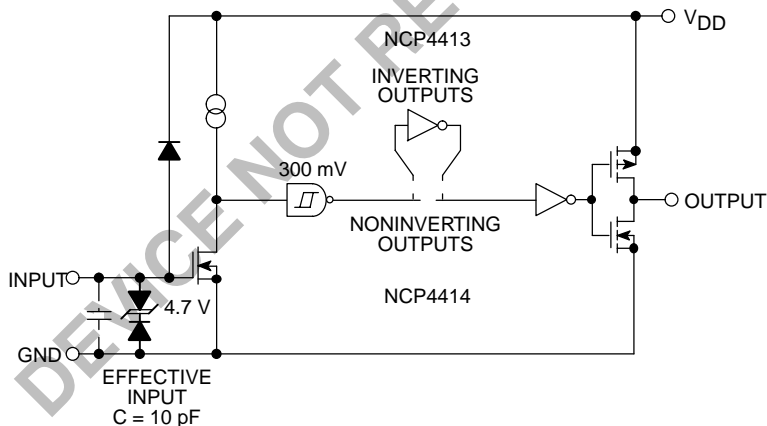

ON Semiconductor®

<http://onsemi.com>

### MARKING DIAGRAM



SO-8  
D SUFFIX  
CASE 751

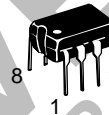
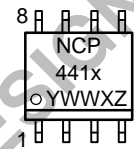

PDIP-8  
P SUFFIX  
CASE 626

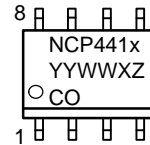

x = Device Number (3 or 4)  
YY, Y = Year  
WW, W = Work Week  
X = Assembly ID Code  
Z = Subcontractor ID Code  
CO = Country of Origin

### ORDERING INFORMATION

Device	Package	Shipping
NCP4413DR2 Inverting	SO-8	2500 Tape & Reel
NCP4413P Inverting	PDIP-8	50 Units/Rail
NCP4414DR2 Non-Inverting	SO-8	2500 Tape & Reel
NCP4414P Non-Inverting	PDIP-8	50 Units/Rail

# NCP4413, NCP4414

## PIN CONNECTIONS

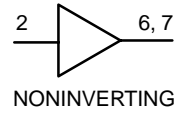
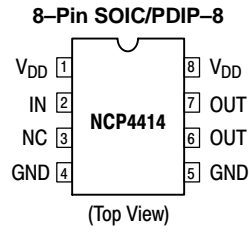
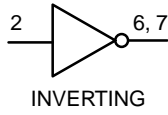
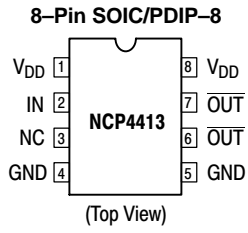

NC = NO INTERNAL CONNECTION

ARCHIVE  
DEVICE NOT RECOMMENDED FOR NEW DESIGN

# NCP4413, NCP4414

## ABSOLUTE MAXIMUM RATINGS\*

Rating	Symbol	Value	Unit
Supply Voltage	$V_{DD}$	+20	V
Input Voltage, IN A or IN B	$V_{IN}$	$V_{DD} + 0.3$ to $GND - 5.0$	V
Maximum Chip Temperature		+150	°C
Storage Temperature Range	$T_{stg}$	-65 to +150	°C
Lead Temperature (Soldering, 10 sec)	$T_{SOI}$	+300	°C
Package Thermal Resistance SOIC SOIC	$R_{\theta JA}$ $R_{\theta JC}$	155 45	°C/W
Operating Temperature Range	$T_A$	-40 to +85	°C
Power Dissipation ( $T_A \leq 70^\circ\text{C}$ ) SOIC	$P_D$	470	mW

\*Static-sensitive device. Unused devices must be stored in conductive material. Protect devices from static discharge and static fields. Stresses above those listed under "Absolute Maximum Ratings" may cause permanent damage to the device. These are stress ratings only and functional operation of the device at these or any other conditions above those indicated in the operation section of the specifications is not implied. Exposure to absolute maximum rating conditions for extended periods may affect device reliability.

## ELECTRICAL CHARACTERISTICS (Over operating temperature range with $4.5\text{ V} \leq V_{DD} \leq 16\text{ V}$ , unless otherwise specified. Typical values are measured at $T_A = 25^\circ\text{C}$ ; $V_{DD} = 16\text{ V}$ .)

Characteristic	Symbol	Test Conditions	Min	Typ	Max	Unit
----------------	--------	-----------------	-----	-----	-----	------

### Input

Logic 1 High Input Voltage	$V_{IH}$	-	2.0	-	-	V
Logic 0 Low Input Voltage	$V_{IL}$	-	-	-	0.8	V
Input Current	$I_{IN}$	$0\text{V} \leq V_{IN} \leq V_{DD}$ $T_A = 25^\circ\text{C}$ $-40^\circ\text{C} \leq T_A \leq 85^\circ\text{C}$	-1.0 -10	-	1.0 10	$\mu\text{A}$

### Output

High Output Voltage	$V_{OH}$	DC Test	$V_{DD} - 0.025$	-	-	V
Low Output Voltage	$V_{OL}$	DC Test	-	-	0.025	v
Output Resistance	$R_O$	$V_{DD} = 16\text{ V}$ , $I_O = 10\text{ mA}$ $T_A = 25^\circ\text{C}$ $-40^\circ\text{C} \leq T_A \leq 85^\circ\text{C}$	- -	2.7 3.3	4.0 5.0	$\Omega$
Peak Output Current	$I_{PK}$	$V_{DD} = 16\text{ V}$	-	3.0	-	A
Latch-Up Protection Withstand Reverse Current	$I_{REV}$	Duty Cycle $\leq 2\%$ $t \leq 300\ \mu\text{sec}$ $V_{DD} = 16\text{ V}$	0.5	-	-	A

### Switching Time (Note 1)

Rise Time	$t_R$	Figure 1 $T_A = 25^\circ\text{C}$ $-40^\circ\text{C} \leq T_A \leq 85^\circ\text{C}$	- -	20 24	28 33	nsec
Fall Time	$t_F$	Figure 1 $T_A = 25^\circ\text{C}$ $-40^\circ\text{C} \leq T_A \leq 85^\circ\text{C}$	- -	20 24	28 33	nsec
Delay Time	$t_{D1}$	Figure 1 $T_A = 25^\circ\text{C}$ $-40^\circ\text{C} \leq T_A \leq 85^\circ\text{C}$	- -	35 40	45 50	nsec
Delay Time	$t_{D2}$	Figure 1 $T_A = 25^\circ\text{C}$ $-40^\circ\text{C} \leq T_A \leq 85^\circ\text{C}$	- -	35 40	45 50	nsec

### Power Supply

Power Supply Current	$I_S$	$V_{IN} = 3\text{ V}$ $V_{IN} = 0\text{ V}$ $V_{DD} = 16\text{ V}$	- -	0.5 0.1	1.0 0.15	mA
----------------------	-------	--	--------	------------	-------------	----

1. Switching times are guaranteed by design.

# NCP4413, NCP4414

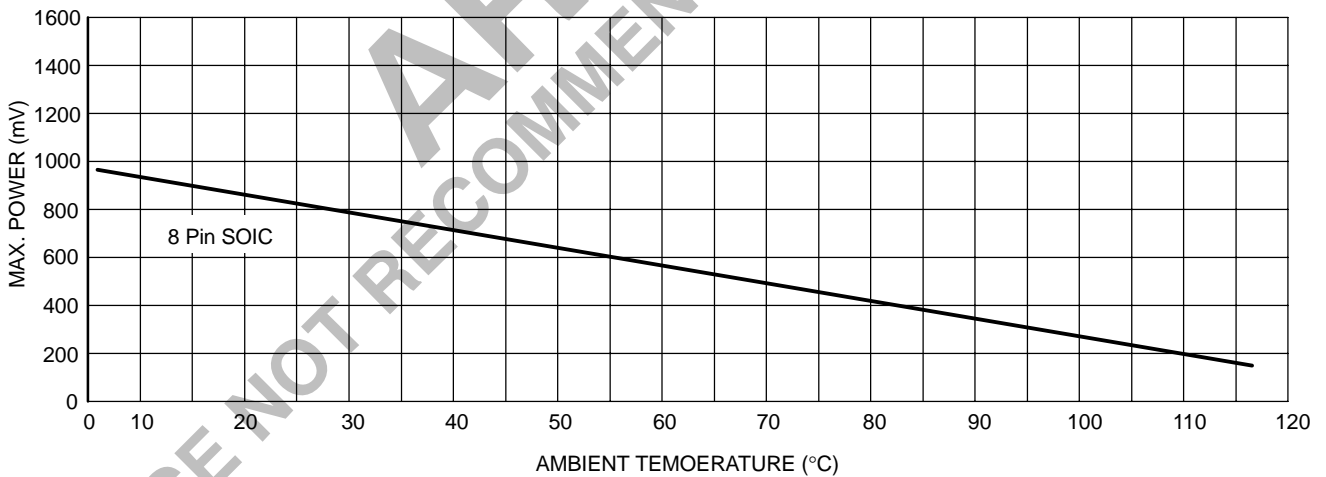
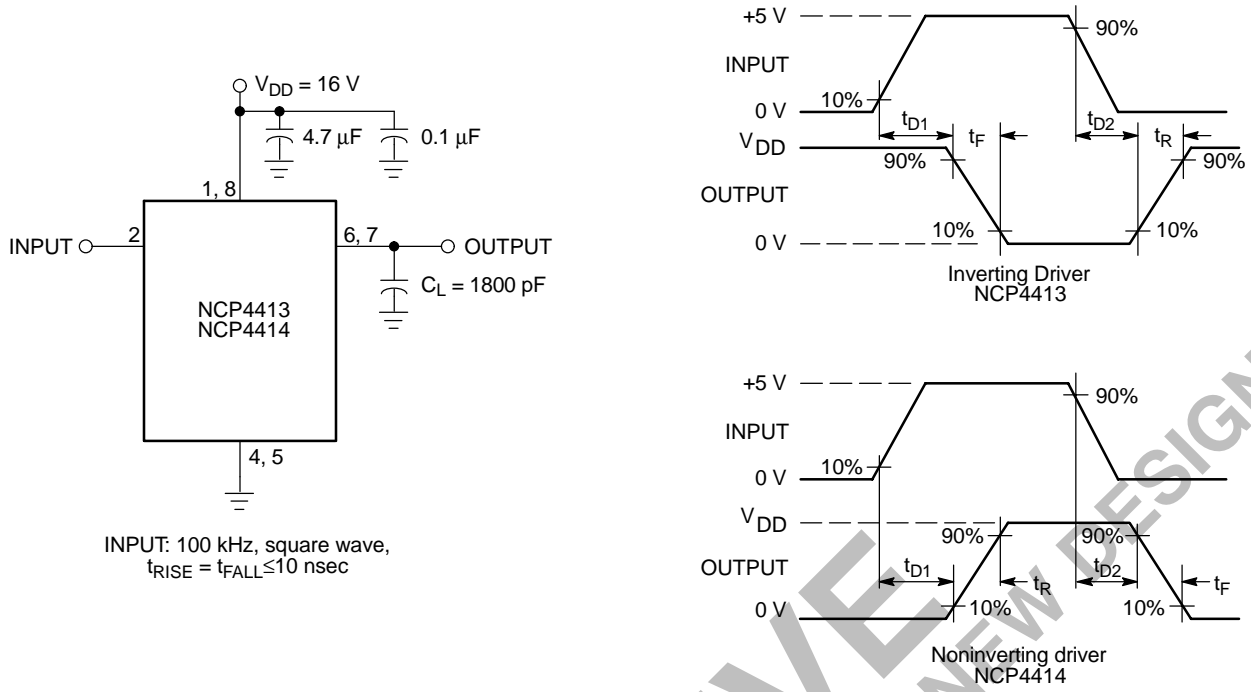
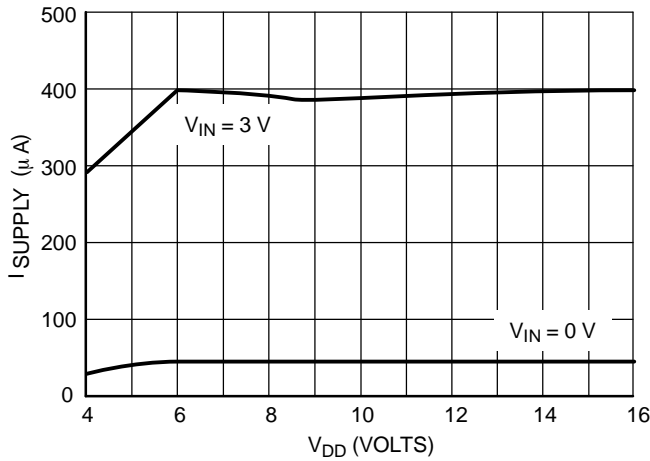

Figure 2. Thermal Derating Curves

# NCP4413, NCP4414

## TYPICAL CHARACTERISTICS



**Figure 3. Quiescent Supply Current vs. Supply Voltage**  
 $T_A = 25^\circ\text{C}$

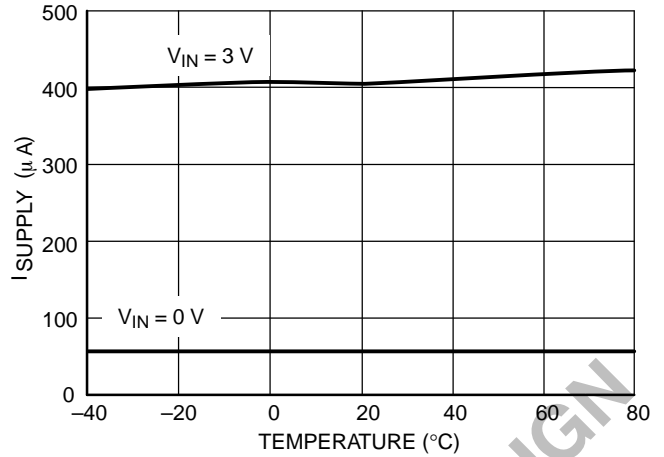

**Figure 4. Quiescent Supply Current vs. Temperature**  
 $V_{\text{SUPPLY}} = 16\text{ V}$

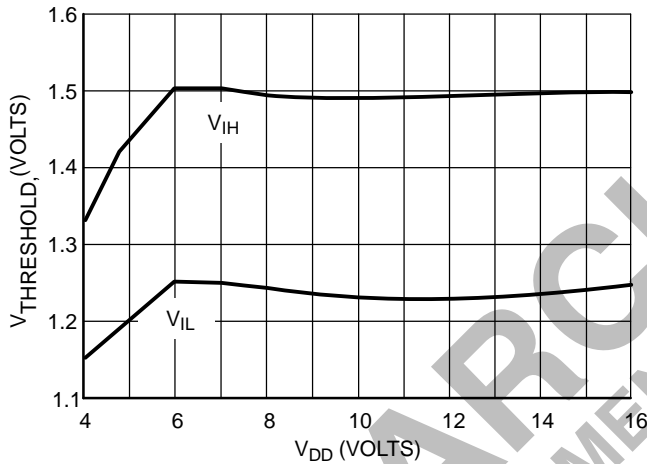

**Figure 5. Input Threshold vs. Supply Voltage**  
 $T_A = 25^\circ\text{C}$

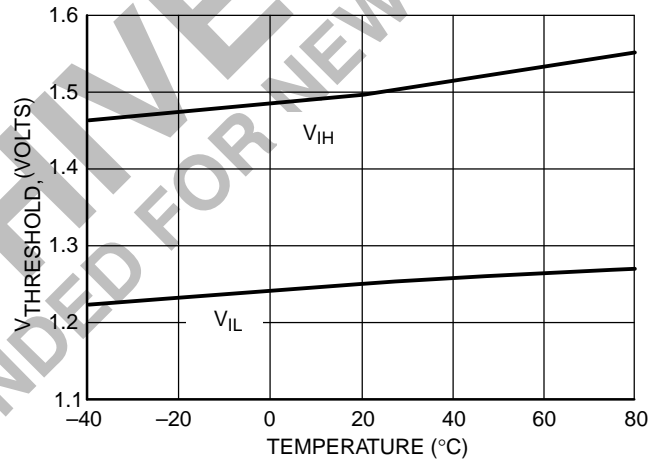

**Figure 6. Input Threshold vs. Temperature**  
 $V_{\text{SUPPLY}} = 16\text{ V}$

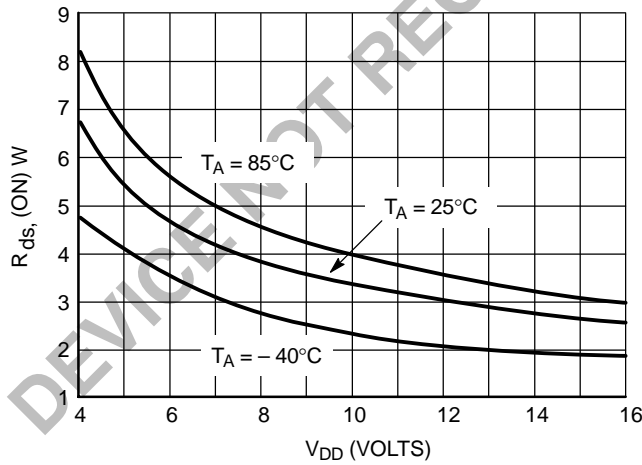

**Figure 7. High-State Output Resistance**

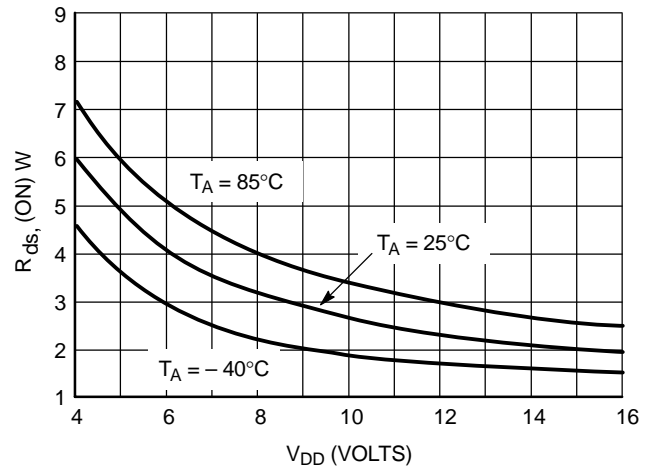

**Figure 8. Low-State Output Resistance**

# NCP4413, NCP4414

## TYPICAL CHARACTERISTICS

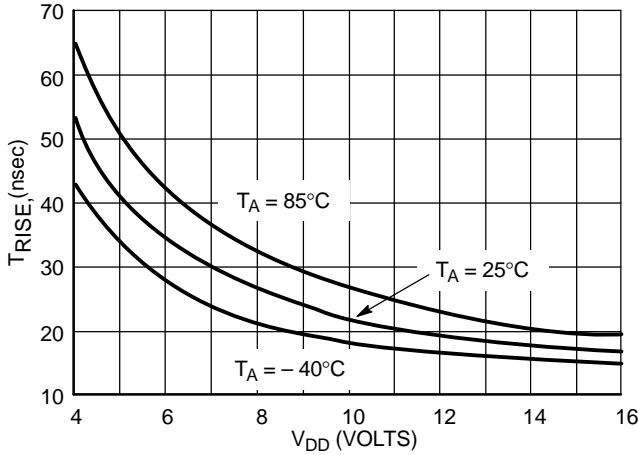

**Figure 9. Rise Time vs. Supply Voltage**  
 $C_{LOAD} = 1800 \text{ pF}$

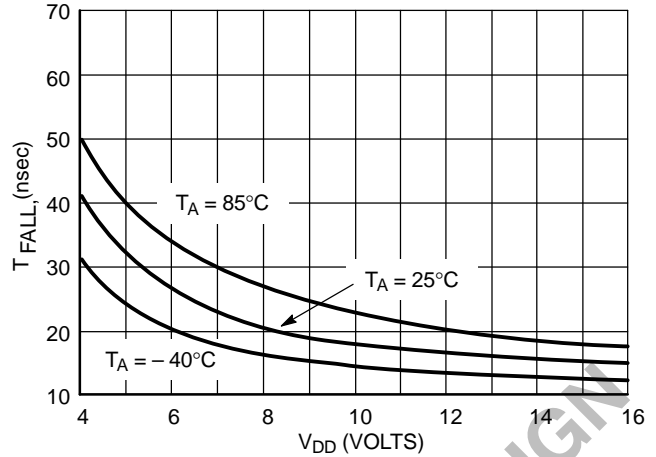

**Figure 10. Fall Time vs. Supply Voltage**  
 $C_{LOAD} = 1800 \text{ pF}$

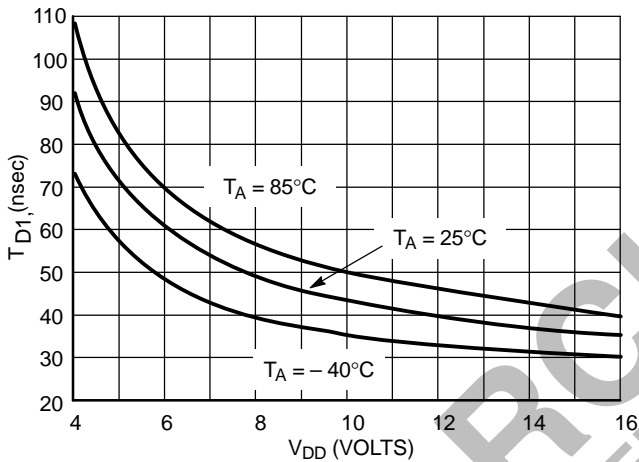

**Figure 11.  $T_{D1}$  Propagation Delay vs. Supply Voltage**  
 $C_{LOAD} = 1800 \text{ pF}$

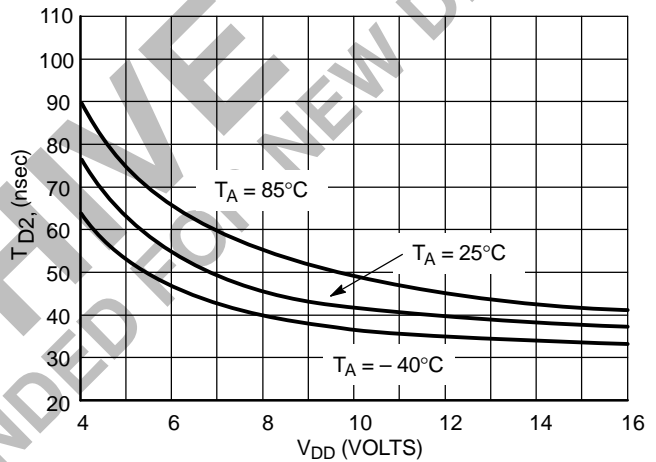

**Figure 12.  $T_{D2}$  Propagation Delay vs. Supply Voltage**  
 $C_{LOAD} = 1800 \text{ pF}$

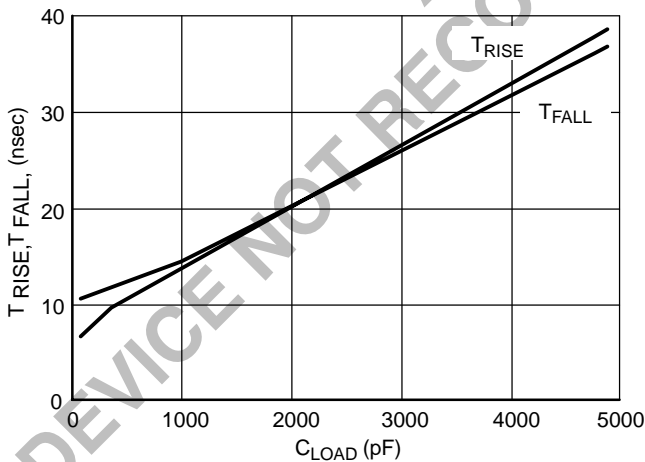

**Figure 13. Rise and Fall Times vs. Capacitive Load**  
 $T_A = 25^\circ\text{C}, V_{DD} = 16 \text{ V}$

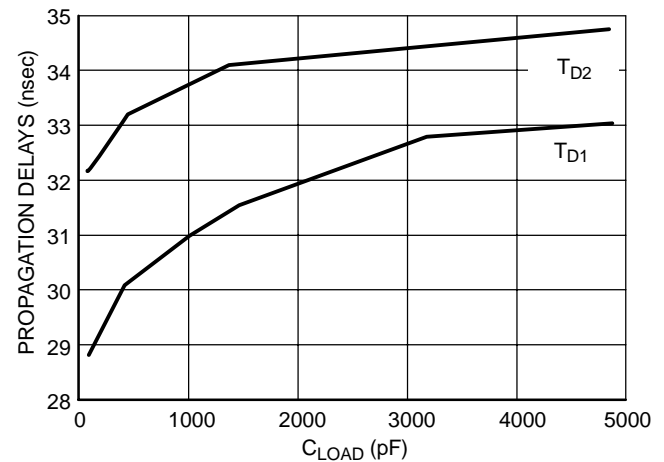
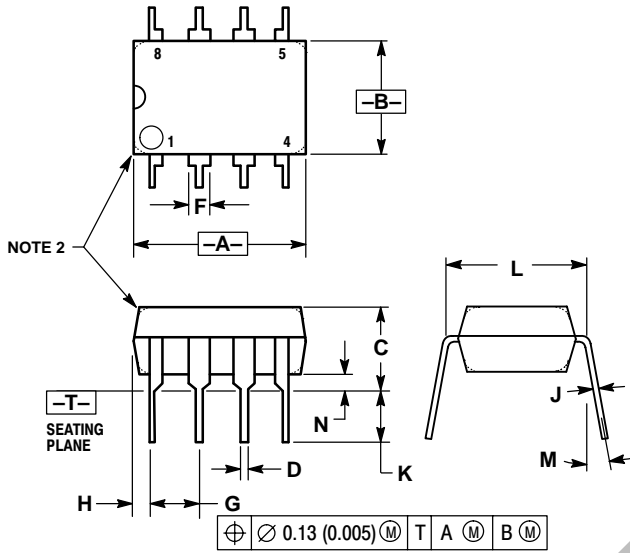

**Figure 14. Propagation Delays vs. Capacitive Load**  
 $T_A = 25^\circ\text{C}, V_{DD} = 16 \text{ V}$

# NCP4413, NCP4414

## PACKAGE DIMENSIONS

PDIP-8  
P SUFFIX  
CASE 626-05  
ISSUE K



NOTES:

1. DIMENSION L TO CENTER OF LEAD WHEN FORMED PARALLEL.
2. PACKAGE CONTOUR OPTIONAL (ROUND OR SQUARE CORNERS).
3. DIMENSIONING AND TOLERANCING PER ANSI Y14.5M, 1982.

DIM	MILLIMETERS		INCHES	
	MIN	MAX	MIN	MAX
A	9.40	10.16	0.370	0.400
B	6.10	6.60	0.240	0.260
C	3.94	4.45	0.155	0.175
D	0.38	0.51	0.015	0.020
F	1.02	1.78	0.040	0.070
G	2.54 BSC		0.100 BSC	
H	0.76	1.27	0.030	0.050
J	0.20	0.30	0.008	0.012
K	2.92	3.43	0.115	0.135
L	7.62 BSC		0.300 BSC	
M	---		10°	
N	0.76	1.01	0.030	0.040

SO-8  
D SUFFIX  
CASE 751-06  
ISSUE T

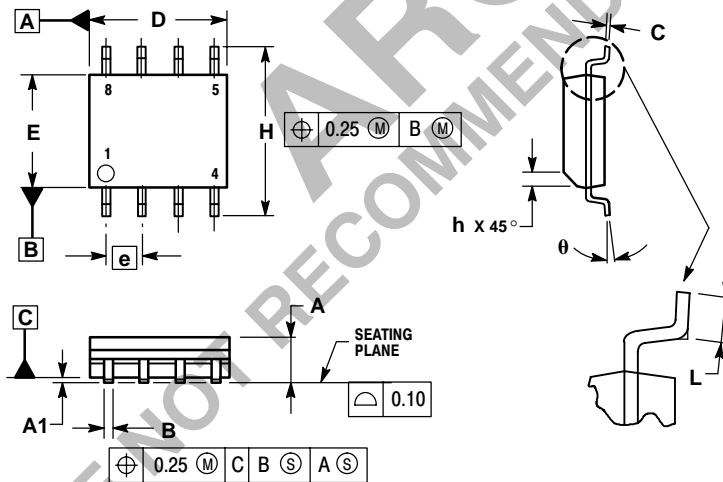

NOTES:

1. DIMENSIONING AND TOLERANCING PER ASME Y14.5M, 1994.
2. DIMENSIONS ARE IN MILLIMETER.
3. DIMENSION D AND E DO NOT INCLUDE MOLD PROTRUSION.
4. MAXIMUM MOLD PROTRUSION 0.15 PER SIDE.
5. DIMENSION B DOES NOT INCLUDE DAMBAR PROTRUSION. ALLOWABLE DAMBAR PROTRUSION SHALL BE 0.127 TOTAL IN EXCESS OF THE B DIMENSION AT MAXIMUM MATERIAL CONDITION.

DIM	MILLIMETERS	
	MIN	MAX
A	1.35	1.75
A1	0.10	0.25
B	0.35	0.49
C	0.19	0.25
D	4.80	5.00
E	3.80	4.00
e	1.27 BSC	
H	5.80	6.20
h	0.25	0.50
L	0.40	1.25
θ	0°	7°

ARCHIVE  
RECOMMENDED FOR NEW DESIGN

ON Semiconductor and  are registered trademarks of Semiconductor Components Industries, LLC (SCILLC). SCILLC reserves the right to make changes without further notice to any products herein. SCILLC makes no warranty, representation or guarantee regarding the suitability of its products for any particular purpose, nor does SCILLC assume any liability arising out of the application or use of any product or circuit, and specifically disclaims any and all liability, including without limitation special, consequential or incidental damages. "Typical" parameters which may be provided in SCILLC data sheets and/or specifications can and do vary in different applications and actual performance may vary over time. All operating parameters, including "Typicals" must be validated for each customer application by customer's technical experts. SCILLC does not convey any license under its patent rights nor the rights of others. SCILLC products are not designed, intended, or authorized for use as components in systems intended for surgical implant into the body, or other applications intended to support or sustain life, or for any other application in which the failure of the SCILLC product could create a situation where personal injury or death may occur. Should Buyer purchase or use SCILLC products for any such unintended or unauthorized application, Buyer shall indemnify and hold SCILLC and its officers, employees, subsidiaries, affiliates, and distributors harmless against all claims, costs, damages, and expenses, and reasonable attorney fees arising out of, directly or indirectly, any claim of personal injury or death associated with such unintended or unauthorized use, even if such claim alleges that SCILLC was negligent regarding the design or manufacture of the part. SCILLC is an Equal Opportunity/Affirmative Action Employer.

## PUBLICATION ORDERING INFORMATION

### Literature Fulfillment:

Literature Distribution Center for ON Semiconductor  
P.O. Box 5163, Denver, Colorado 80217 USA  
Phone: 303-675-2175 or 800-344-3860 Toll Free USA/Canada  
Fax: 303-675-2176 or 800-344-3867 Toll Free USA/Canada  
Email: ONlit@hibbertco.com

N. American Technical Support: 800-282-9855 Toll Free USA/Canada

JAPAN: ON Semiconductor, Japan Customer Focus Center  
2-9-1 Kamimeguro, Meguro-ku, Tokyo, Japan 153-0051  
Phone: 81-3-5773-3850  
Email: r14525@onsemi.com

ON Semiconductor Website: <http://onsemi.com>

For additional information, please contact your local Sales Representative.