

High Reliability Hallogic Hall-Effect Sensors

OMH090 OMH3019, OMH3020, OMH3040, OMH3075,
OMH3131 (B, S versions)



Features:

- Designed for non-contact switching operations
- Operates over a broad range of supply voltages
- Excellent temperature stability operates in harsh environments
- Suitable for military and space applications
- Processing patterned after class B or S of MIL-STD-883
- Through Hole 0.40" [10.16 mm] lead length minimum
- Surface Mount 0.125" [3.18 mm] lead length
- ESD Rating of Class 3B per MIL-STD-883G, M3015.7, HB model.

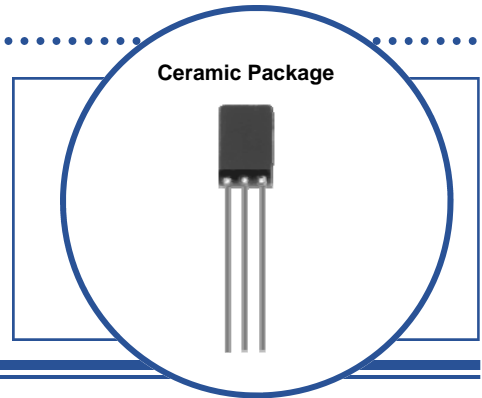

Description:

These Hall-effect devices contain a monolithic integrated circuit which incorporates a Hall element, a linear amplifier, a threshold amplifier, and Schmitt trigger on a single Hallogic® silicon chip. Included on-chip is a band-gap voltage regulator that allows operation with a wide range of supply voltages. These devices feature logic level output and provide up to 21 mA of sink current. This allows direct driving of more than 7 TTL loads or any standard logic family using power supplies ranging from 4.5 to 24 volts. Output amplitude is constant at switching frequencies from DC to over 200 kHz.

The **Uni-Polar** turns on with a (logic level "0") after a sufficient magnetic field from the south pole of a magnet approaches the symbolized face of the device (operating point) and turns off (logic level "1") after the magnetic field reaches a minimum value. The **Bi-Polar** device turns on (logic level "0") in the presence of a magnetic south pole and turns off (logic level "1") when subjected to a magnetic north pole. Both magnetic poles are necessary for operation for Bi-Polar devices. This feature makes these sensors ideal for applications in non-contact switching operations, brushless DC motors and for use with multiple pole magnets.

B and S devices are processed to OPTEK's military screening program patterned after MIL-STD-883. This product has passed Radiation Hardness testing up to 350 Krad (si) per MIL-STD-883 method 1019.6 and up to 150 Krad (si) for ELDRS.

Contact your local representative or OPTEK for more information.

Applications:

- Non-contact switching operations
- Brushless DC motors
- Multiple pole magnets
- Non-contact reflective object sensor
- Assembly line automation
- Machine automation
- Machine safety
- End of travel sensor
- Door sensor

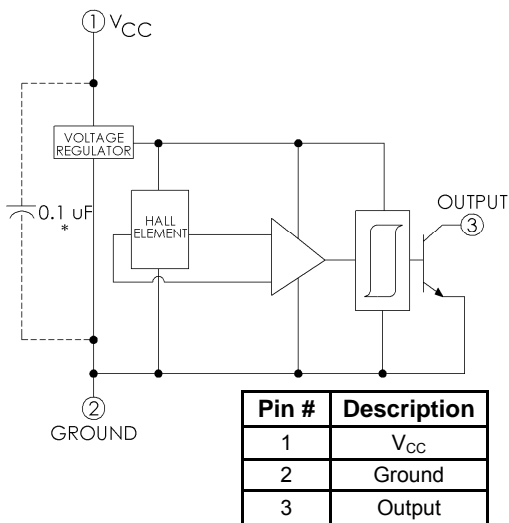

* Add capacitor for stable operation

Lead finish = Solder Dipped (Sn 63/37)

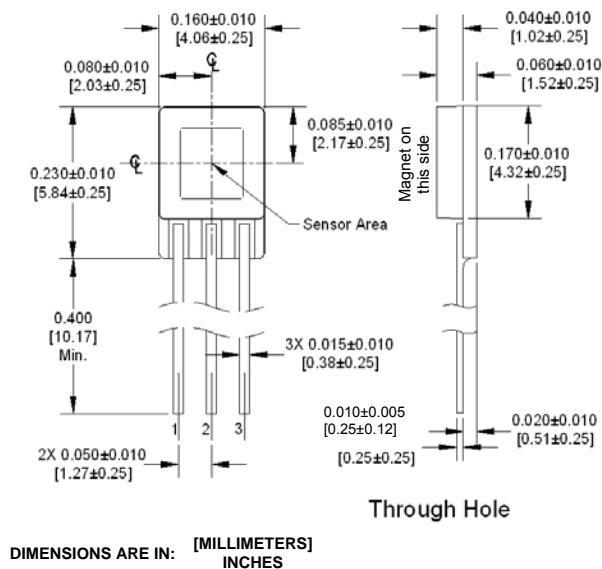

Through Hole

OPTEK reserves the right to make changes at any time in order to improve design and to supply the best product possible.

High Reliability Hallogic Hall-Effect Sensors
OMH090 OMH3019, OMH3020, OMH3040, OMH3075,
OMH3131 (B, S versions)



Absolute Maximum Ratings ($T_A = 25^\circ\text{C}$ unless otherwise noted)

Supply Voltage, V_{CC}	25 V
Storage Temperature Range, T_S	-65°C to +150°C
Operating Temperature Range, T_A	-55°C to +125°C
Lead Soldering Temperature (1/8 in. (3.2 mm) from case for 5 seconds with soldering iron)	260°C ⁽¹⁾
Output ON Current, I_{SINK}	25 mA
Output OFF Voltage, V_{OUT}	25 V
Magnetic Flux Density, B	Unlimited

Notes:

(1) Heat sink leads during hand soldering.

25°C

Part Number	Hi-Reliability Hallogic® Sensor	Operate Point Gauss Min / Typ / Max	Release Point Gauss Min / Typ / Max	Hysteresis Gauss Min / Typ / Max	V_{CC} (Volts) Min / Max	Package
OMH090B	Uni-Polar Non-Latching	70/90/200	30 / 65 / 180	10 / 30 / 60	4.5 / 24.0	Through Hole
OMH090S						
OMH3019B		175 / 300 / 500	125 / 235 / 420	30 / 100 / 155		
OMH3019S						
OMH3020B		70 / 220 / 350	50 / 180 / 330	15 / 55 / 200		
OMH3020S						
OMH3040B		70 / 150 / 200	50 / 115 / 180	10 / 35 / 60		
OMH3040S						
OMH3131B		20 / 60 / 95	10 / 45 / 85	5 / 15 / 40		
OMH3131S						
OMH3075B	Bi-Polar Latching	50 / 150 / 250	-250 / -150 / -50	100 / 250 / 500		
OMH3075S						

OPTEK reserves the right to make changes at any time in order to improve design and to supply the best product possible.

High Reliability Hallogic Hall-Effect Sensors
OMH090, OMH3019, OMH3020, OMH3040, OMH3075,
OMH3131 (B, S versions)



Electrical Characteristics ($V_{CC} = 4.5\text{ V to }24\text{ V}$, $T_A = 25^\circ\text{ C}$ unless otherwise noted)
OMH090, OMH090B, OMH090S Uni-Polar

SYMBOL	PARAMETER	MIN	TYP	MAX	UNITS	TEST CONDITIONS
B_{OP}	Magnetic Operate Point ⁽¹⁾	45 70 20	- 90 -	210 200 180	Gauss	-55°C +25°C +125°C
B_{RP}	Magnetic Release Point	30 25	65 -	180 170	Gauss	-55°C & +25°C +125°C
B_H	Magnetic Hysteresis	5 10	- 30	95 60	Gauss	-55°C +25°C & +125°C
I_{CC}	Supply Current	- - -	- 5 -	9 11 5	mA	-55°C, $V_{CC} = 24\text{ V}$, Output On, $B \leq 250\text{ Gauss}$ +25° +125°C
V_{OL}	Output Saturation Voltage	- -	- 125	300 400	mV	-55°C, $V_{CC} = 4.5\text{ V}$, $I_{OL} = 30\text{ mA}$, $B \geq 250\text{ Gauss}$ +25°C & +125°C
I_{OH}	Output Leakage Current	- - -	- 0.50 -	10 11 12	μA	-55°C, $V_{CC} = 24\text{ V}$, $V_{OUT} = 24\text{ V}$, $B \leq 250\text{ Gauss}$ +25° +125°C
t_r	Output Rise Time	-	0.13	1.00	μs	$R_L = 820\ \Omega$, $C_L = 20\text{ pF}$, $V_{CC} = 14\text{ V}$ (guaranteed not tested)
t_f	Output Fall Time	-	0.14	1.00	μs	

Electrical Characteristics ($V_{CC} = 4.5\text{ V to }24\text{ V}$, $T_A = 25^\circ\text{ C}$ unless otherwise noted)
OMH3019, OMH3019B, OMH3019S Uni-Polar

SYMBOL	PARAMETER	MIN	TYP	MAX	UNITS	TEST CONDITIONS
B_{OP}	Magnetic Operate Point ⁽¹⁾	175 -	300 -	500 575	Gauss	+25°C -55°C & +125°C
B_{RP}	Magnetic Release Point	125 100	235 -	420 -	Gauss	+25°C -55°C & +125°C
B_H	Magnetic Hysteresis	30 20	100 -	155 -	Gauss	+25°C -55°C to +125°C
I_{CC}	Supply Current	-	5	9	mA	$V_{CC} = 24\text{ V}$, Output On, $B \leq 50\text{ Gauss}$
V_{OL}	Output Saturation Voltage	-	125	300	mV	$V_{CC} = 4.5\text{ V}$, $I_{OL} = 15\text{ mA}$, $B \geq 500\text{ Gauss}$
I_{OH}	Output Leakage Current	-	0.10	1.0	μA	$V_{CC} = 24\text{ V}$, $V_{OUT} = 24\text{ V}$, $B < 50\text{ Gauss}$
t_r	Output Rise Time	-	0.13	1	μs	$R_L = 460\ \Omega$, $C_L = 20\text{ pF}$, $V_{CC} = 12\text{ V}$ (guaranteed not tested)
t_f	Output Fall Time	-	0.14	1	μs	

Notes:

- (1) South pole facing symbolized surface.

OPTEK reserves the right to make changes at any time in order to improve design and to supply the best product possible.

Electrical Characteristics ($V_{CC} = 4.5\text{ V to }24\text{ V}$, $T_A = 25^\circ\text{ C}$ unless otherwise noted)
OMH3020, OMH3020B, OMH3020S Uni-Polar

SYMBOL	PARAMETER	MIN	TYP	MAX	UNITS	TEST CONDITIONS
B_{OP}	Magnetic Operate Point ⁽¹⁾	70 -	220 -	350 425	Gauss	+25°C -55°C & +125°C
B_{RP}	Magnetic Release Point	50 25	180 -	330 -	Gauss	+25°C -55°C & +125°C
B_H	Magnetic Hysteresis	15 10	55 -	200 -	Gauss	+25°C -55°C & +125°C
I_{CC}	Supply Current	-	4	7	mA	$V_{CC} = 24\text{ V}$, Output On, $B \leq 50\text{ Gauss}$
V_{OL}	Output Saturation Voltage	-	100	400	mV	$V_{CC} = 4.5\text{ V}$, $I_{OL} = 15\text{ mA}$, $B \geq 350\text{ Gauss}$
I_{OH}	Output Leakage Current	-	0.10	10	μA	$V_{CC} = 24\text{ V}$, $V_{OUT} = 24\text{ V}$, $B \leq 50\text{ Gauss}$
t_r	Output Rise Time	-	0.21	1	μs	$R_L = 820\ \Omega$, $C_L = 20\text{ pF}$, $V_{CC} = 12\text{ V}$ (guaranteed not tested)
t_f	Output Fall Time	-	0.10	1	μs	

Electrical Characteristics ($V_{CC} = 4.5\text{ V to }24\text{ V}$, $T_A = 25^\circ\text{ C}$ unless otherwise noted)
OMH3040, OMH3040B, OMH3040S Uni-Polar

SYMBOL	PARAMETER	MIN	TYP	MAX	UNITS	TEST CONDITIONS
B_{OP}	Magnetic Operate Point ⁽¹⁾	70 75	150 -	200 270	Gauss	+25°C -55°C & +125°C
B_{RP}	Magnetic Release Point	50 25	115 -	180 210	Gauss	+25°C -55°C & +125°C
B_H	Magnetic Hysteresis	10 20	35 -	60 -	Gauss	+25°C -55°C & +125°C
I_{CC}	Supply Current	- -	4 -	7 8 10	mA	+25°C, $V_{CC} = 24\text{ V}$, Output On, $B \geq 300\text{ Gauss}$ +125°C -55°C
V_{OL}	Output Saturation Voltage	-	100	400	mV	$V_{CC} = 4.5\text{ V}$, $I_{OL} = 20\text{ mA}$, $B \geq 250\text{ Gauss}$
I_{OH}	Output Leakage Current	- - -	- 0.10 -	11 10 12	μA	-55°C, $V_{CC} = 24\text{ V}$, $V_{OUT} = 24\text{ V}$, $B \leq 75\text{ Gauss}$ +25°C, $V_{CC} = 24\text{ V}$, $V_{OUT} = 24\text{ V}$, $B \leq 100\text{ Gauss}$ +125°C, $V_{CC} = 24\text{ V}$, $V_{OUT} = 24\text{ V}$, $B \leq 75\text{ G}$
t_r	Output Rise Time	-	0.21	1	μs	$R_L = 820\ \Omega$, $C_L = 20\text{ pF}$, $V_{CC} = 12\text{ V}$ (guaranteed not tested)
t_f	Output Fall Time	-	0.10	1	μs	

Notes:

(1) South pole facing symbolized surface.

OPTEK reserves the right to make changes at any time in order to improve design and to supply the best product possible.

Electrical Characteristics ($V_{CC} = 4.5\text{ V to }24\text{ V}$, $T_A = 25^\circ\text{ C}$ unless otherwise noted)
OMH3075, OMH3075B, OMH3075S Bi-Polar Latching

SYMBOL	PARAMETER	MIN	TYP	MAX	UNITS	TEST CONDITIONS
B_{OP}	Magnetic Operate Point ⁽¹⁾	50 25	150 -	250 275	Gauss	+25°C -55°C & +125°C
B_{RP}	Magnetic Release Point	-250 -275	-150 -	-50 -25	Gauss	+25°C -55°C & +125°C
B_H	Magnetic Hysteresis	100 50	250 -	500 -	Gauss	+25°C -55°C & +125°C
I_{CC}	Supply Current	- -	4 -	7 8	mA	+25°C, $V_{CC} = 24\text{ V}$, Output On, $B \leq 250\text{ Gauss}$ -55°C & +125°C
V_{OL}	Output Saturation Voltage	- - -	- 100 -	500 400 400	mV	-55°C +25°C, $V_{CC} = 4.5\text{ V}$, $I_{OL} = 20\text{ mA}$, $B \geq 250\text{ Gauss}$ +125°C
I_{OH}	Output Leakage Current	-	0.10	1.0	μA	$V_{CC} = 24\text{ V}$, $V_{OUT} = 24\text{ V}$, $B \leq 250\text{ Gauss}$
t_r	Output Rise Time	-	0.21	1	μs	$R_L = 820\ \Omega$, $C_L = 20\text{ pF}$, $V_{CC} = 12\text{ V}$ (guaranteed not tested)
t_f	Output Fall Time	-	0.10	1	μs	

Electrical Characteristics ($V_{CC} = 4.5\text{ V to }24\text{ V}$, $T_A = 25^\circ\text{ C}$ unless otherwise noted)
OMH3131, OMH3131B & OMS3131S Uni-Polar

SYMBOL	PARAMETER	MIN	TYP	MAX	UNITS	TEST CONDITIONS
B_{OP}	Magnetic Operate Point ⁽¹⁾	20 10	60 -	95 150	Gauss	+25°C -55°C to +125°C
B_{RP}	Magnetic Release Point	10 5	45 -	85 145	Gauss	+25°C -55°C to +125°C
B_H	Magnetic Hysteresis	5 5	15 -	40 145	Gauss	+25°C -55°C to +125°C
I_{CC}	Supply Current	-	4	7	mA	$V_{CC} = 24\text{ V}$, Output On, $B > 250\text{ Gauss}$
V_{OL}	Output Saturation Voltage	-	100	400	mV	$V_{CC} = 4.5\text{ V}$, $I_{OL} = 15\text{ mA}$, $B \geq 250\text{ Gauss}$
I_{OH}	Output Leakage Current	-	0.10	10	μA	$V_{CC} = 24\text{ V}$, $V_{OUT} = 24\text{ V}$, $B \leq 0\text{ Gauss}$
t_r	Output Rise Time	-	0.21	1	μs	$R_L = 820\ \Omega$, $C_L = 20\text{ pF}$, $V_{CC} = 12\text{ V}$ (guaranteed not tested)
t_f	Output Fall Time	-	0.10	1	μs	

Notes:

(1) South pole facing symbolized surface.

OPTEK reserves the right to make changes at any time in order to improve design and to supply the best product possible.

OMH090, OMH3019, OMH3020, OMH3040, OMH3075, OMH3131 (B, S)

Magnetic Operate & Release Points vs Temperature

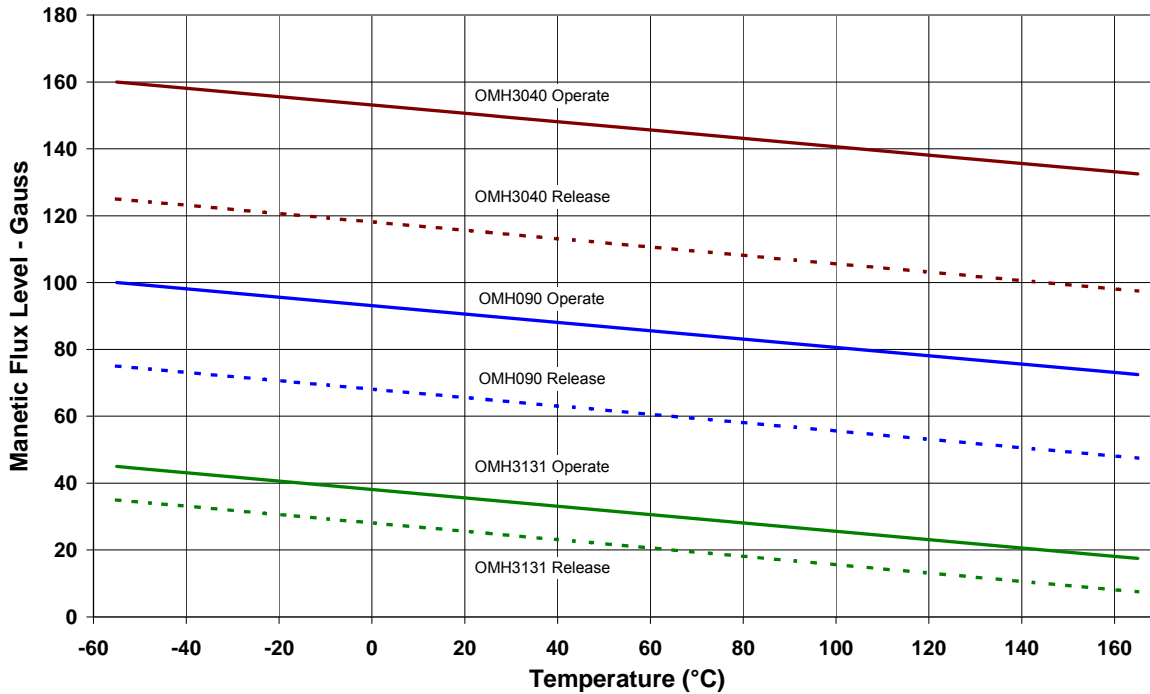

Magnetic Operate & Release Points vs Temperature

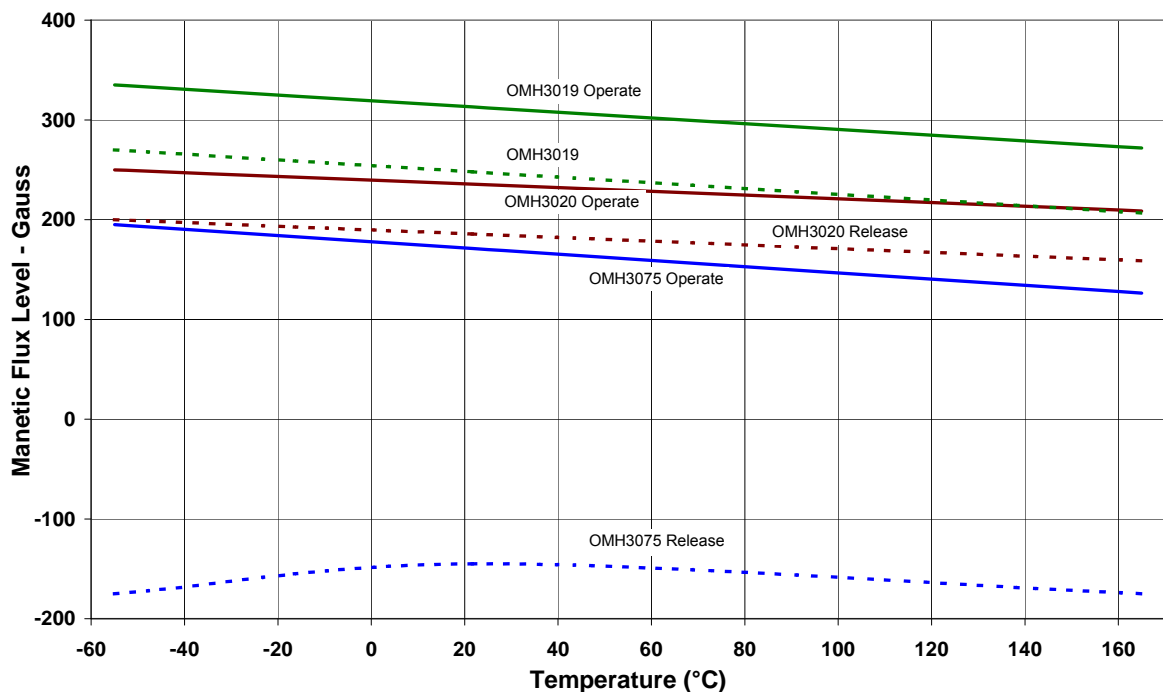

OPTeK reserves the right to make changes at any time in order to improve design and to supply the best product possible.

OMH090, OMH3019, OMH3020, OMH3040, OMH3075, OMH3131 (B, S)

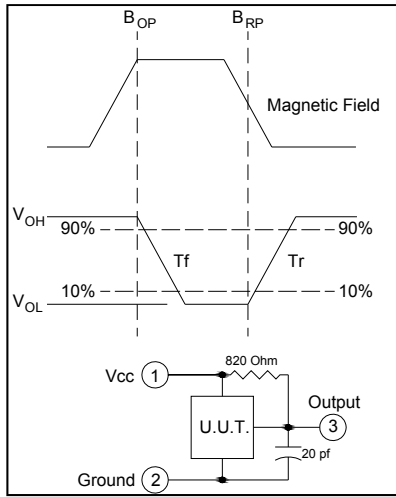

Rise and Fall Time vs Temperature

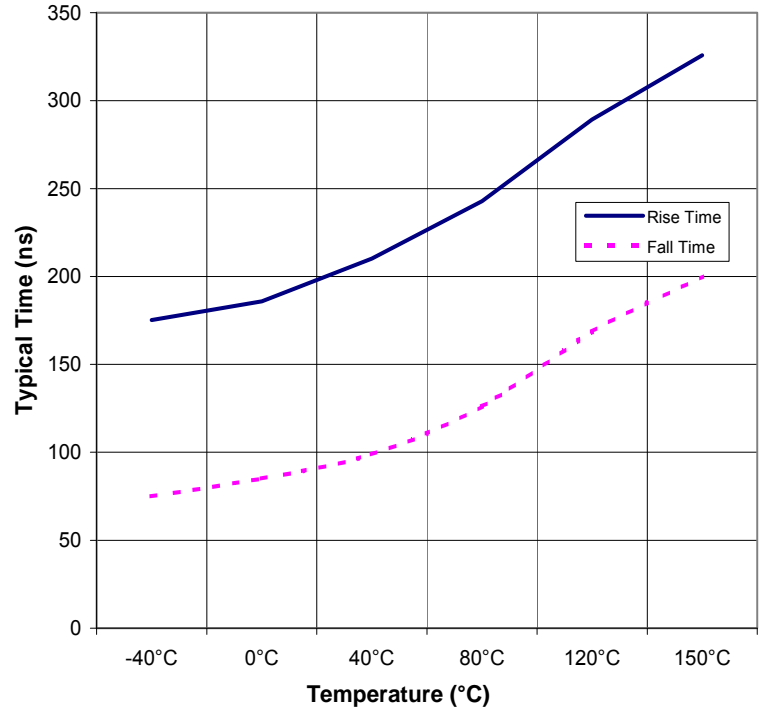

I_{CC} vs Temperature

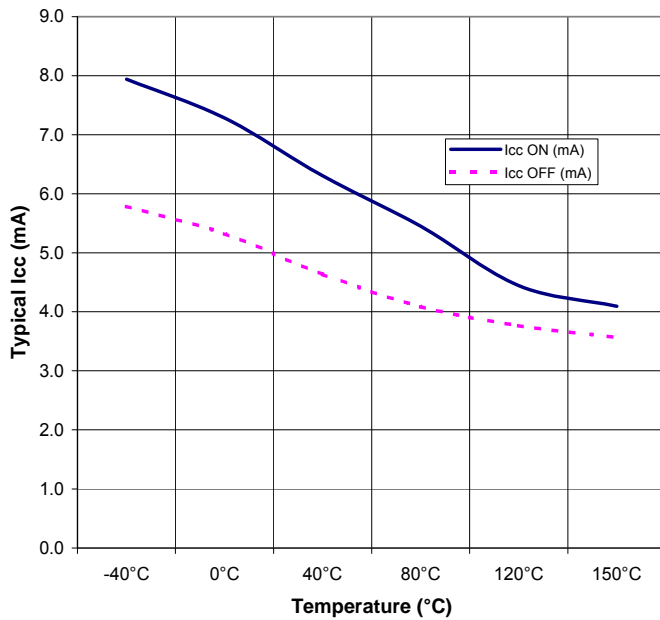

Saturation Voltage vs Temperature

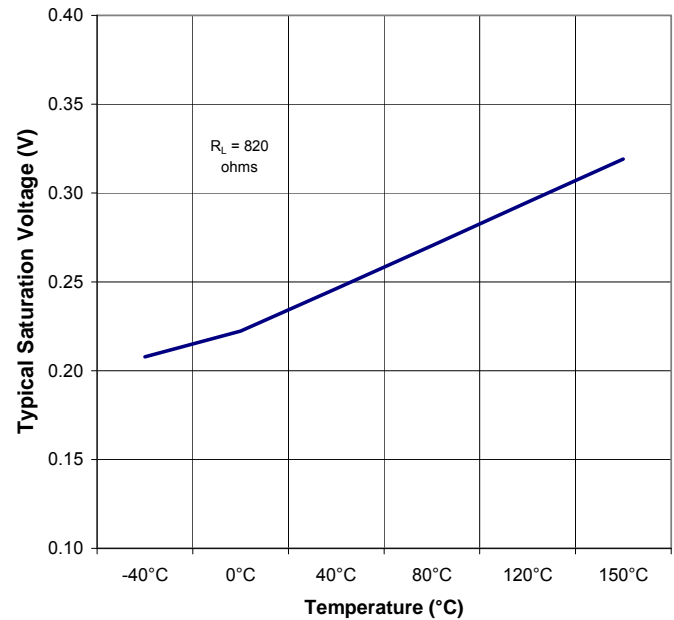

OPTEK reserves the right to make changes at any time in order to improve design and to supply the best product possible.