

500 kHz, 800 μ A Instrumentation Amplifier

Features

- Rail-to-Rail Input and Output
- Gain Set by 2 External Resistors
- Minimum Gain (G_{MIN}) Options:
1, 2, 5, 10 or 100 V/V
- Common Mode Rejection Ratio (CMRR): 115 dB (typical, $G_{MIN} = 100$)
- Power Supply Rejection Ratio (PSRR): 112 dB (typical, $G_{MIN} = 100$)
- Bandwidth: 500 kHz (typical, Gain = G_{MIN})
- Supply Current: 800 μ A/channel (typical)
- Single Channel
- Enable/ V_{OS} Calibration pin: ($\overline{EN/CAL}$)
- Power Supply: 1.8V to 5.5V
- Extended Temperature Range: -40°C to +125°C

Typical Applications

- High Side Current Sensor
- Wheatstone Bridge Sensors
- Difference Amplifier with Level Shifting
- Power Control Loops

Design Aids

- Microchip Advanced Part Selector (MAPS)
- Demonstration Board
- Application Notes

Block Diagram

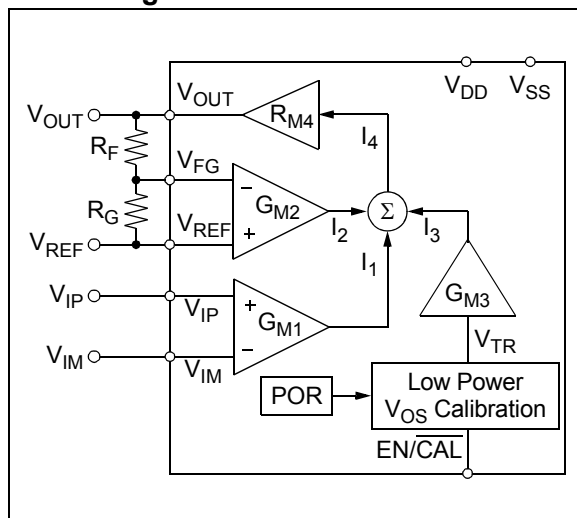

Description

Microchip Technology Inc. offers the single MCP6N11 instrumentation amplifier (INA) with Enable/ V_{OS} Calibration pin ($\overline{EN/CAL}$) and several minimum gain options. It is optimized for single-supply operation with rail-to-rail input (no common mode crossover distortion) and output performance.

Two external resistors set the gain, minimizing gain error and drift-over temperature. The reference voltage (V_{REF}) shifts the output voltage (V_{OUT}).

The supply voltage range (1.8V to 5.5V) is low enough to support many portable applications. All devices are fully specified from -40°C to +125°C.

These parts have five minimum gain options (1, 2, 5, 10 and 100 V/V). This allows the user to optimize the input offset voltage and input noise for different applications.

Typical Application Circuit

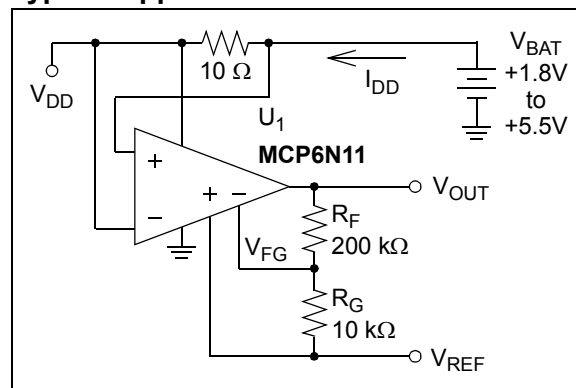

Package Types

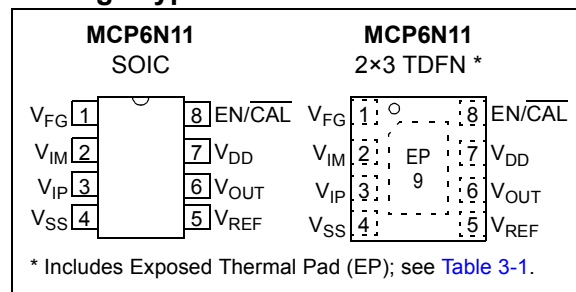

MCP6N11

Minimum Gain Options

Table 1 shows key specifications that differentiate between the different minimum gain (G_{MIN}) options. See [Section 1.0 “Electrical Characteristics”](#), [Section 6.0 “Packaging Information”](#) and [Product Identification System](#) for further information on G_{MIN} .

TABLE 1: KEY DIFFERENTIATING SPECIFICATIONS

Part No.	G_{MIN} (V/V) Nom.	V_{OS} (\pm mV) Max.	$\Delta V_{OS}/\Delta T_A$ (\pm μ V/ $^{\circ}$ C) Typ.	CMRR (dB) Min. $V_{DD} = 5.5V$	PSRR (dB) Min.	V_{DMH} (V) Max.	GBWP (MHz) Nom.	E_{ni} (μ V _{P-P}) Nom. (f = 0.1 to 10 Hz)	e_{ni} (nV/ \sqrt Hz) Nom. (f = 10 kHz)
MCP6N11-001	1	3.0	90	70	62	2.70	0.50	570	950
MCP6N11-002	2	2.0	45	78	68	1.35	1.0	285	475
MCP6N11-005	5	0.85	18	80	75	0.54	2.5	114	190
MCP6N11-010	10	0.50	9.0	81	81	0.27	5.0	57	95
MCP6N11-100	100	0.35	2.7	88	86	0.027	35	18	35

1.0 ELECTRICAL CHARACTERISTICS

1.1 Absolute Maximum Ratings †

$V_{DD} - V_{SS}$	6.5V
Current at Input Pins ††	±2 mA
Analog Inputs (V_{IP} and V_{IM}) ††	$V_{SS} - 1.0V$ to $V_{DD} + 1.0V$
All Other Inputs and Outputs	$V_{SS} - 0.3V$ to $V_{DD} + 0.3V$
Difference Input Voltage	$ V_{DD} - V_{SS} $
Output Short Circuit Current	Continuous
Current at Output and Supply Pins	±30 mA
Storage Temperature	-65°C to +150°C
Max. Junction Temperature	+150°C
ESD protection on all pins (HBM, CDM, MM)	≥ 2 kV, 1.5 kV, 300V

† **Notice:** Stresses above those listed under “Absolute Maximum Ratings” may cause permanent damage to the device. This is a stress rating only and functional operation of the device at those or any other conditions above those indicated in the operational listings of this specification is not implied. Exposure to maximum rating conditions for extended periods may affect device reliability.

†† See [Section 4.2.1.2 “Input Voltage Limits”](#) and [Section 4.2.1.3 “Input Current Limits”](#).

1.2 Specifications

TABLE 1-1: DC ELECTRICAL SPECIFICATIONS

Electrical Characteristics: Unless otherwise indicated, $T_A = +25^\circ\text{C}$, $V_{DD} = 1.8V$ to $5.5V$, $V_{SS} = \text{GND}$, $\text{EN}/\overline{\text{CAL}} = V_{DD}$, $V_{CM} = V_{DD}/2$, $V_{DM} = 0V$, $V_{REF} = V_{DD}/2$, $V_L = V_{DD}/2$, $R_L = 10\text{ k}\Omega$ to V_L and $G_{DM} = G_{MIN}$; see Figure 1-6 and Figure 1-7 .							
Parameters	Sym	Min	Typ	Max	Units	G_{MIN}	Conditions
Input Offset							
Input Offset Voltage, Calibrated	V_{OS}	-3.0	—	+3.0	mV	1	(Note 2)
		-2.0	—	+2.0	mV	2	
		-0.85	—	+0.85	mV	5	
		-0.50	—	+0.50	mV	10	
		-0.35	—	+0.35	mV	100	
Input Offset Voltage Trim Step	V_{OSTRM}	—	0.36	—	mV	1	
		—	0.21	—	mV	2	
		—	0.077	—	mV	5	
		—	0.045	—	mV	10	
		—	0.014	—	mV	100	
Input Offset Voltage Drift	$\Delta V_{OS}/\Delta T_A$	—	±90/ G_{MIN}	—	$\mu\text{V}/^\circ\text{C}$	1 to 10	$T_A = -40^\circ\text{C}$ to $+125^\circ\text{C}$ (Note 3)
		—	±2.7	—	$\mu\text{V}/^\circ\text{C}$	100	
Power Supply Rejection Ratio	PSRR	62	82	—	dB	1	
		68	88	—	dB	2	
		75	96	—	dB	5	
		81	102	—	dB	10	
		86	112	—	dB	100	

- Note**
- $V_{CM} = (V_{IP} + V_{IM}) / 2$, $V_{DM} = (V_{IP} - V_{IM})$ and $G_{DM} = 1 + R_F/R_G$.
 - The V_{OS} spec limits include 1/f noise effects.
 - This is the input offset drift without V_{OS} re-calibration; toggle $\text{EN}/\overline{\text{CAL}}$ to minimize this effect.
 - These specs apply to both the V_{IP} , V_{IM} input pair (use V_{CM}) and to the V_{REF} , V_{FG} input pair (V_{REF} takes V_{CM} 's place).
 - This spec applies to the V_{IP} , V_{IM} , V_{REF} and V_{FG} pins individually.
 - [Figure 2-11](#) and [Figure 2-19](#) show the V_{IVR} and V_{DMR} variation over temperature.
 - See [Section 1.5 “Explanation of DC Error Specs”](#).

MCP6N11

TABLE 1-1: DC ELECTRICAL SPECIFICATIONS (CONTINUED)

Electrical Characteristics: Unless otherwise indicated, $T_A = +25^\circ\text{C}$, $V_{DD} = 1.8\text{V to } 5.5\text{V}$, $V_{SS} = \text{GND}$, $\overline{\text{EN/CAL}} = V_{DD}$, $V_{CM} = V_{DD}/2$, $V_{DM} = 0\text{V}$, $V_{REF} = V_{DD}/2$, $V_L = V_{DD}/2$, $R_L = 10\text{ k}\Omega$ to V_L and $G_{DM} = G_{MIN}$; see [Figure 1-6](#) and [Figure 1-7](#).

Parameters	Sym	Min	Typ	Max	Units	G_{MIN}	Conditions	
Input Current and Impedance (Note 4)								
Input Bias Current	I_B	—	10	—	pA	all		
Across Temperature		—	80	—	pA			$T_A = +85^\circ\text{C}$
Across Temperature		0	2	5	nA			$T_A = +125^\circ\text{C}$
Input Offset Current	I_{OS}	—	± 1	—	pA			
Across Temperature		—	± 5	—	pA			$T_A = +85^\circ\text{C}$
Across Temperature		-1	± 0.05	+1	nA			$T_A = +125^\circ\text{C}$
Common Mode Input Impedance	Z_{CM}	—	$10^{13} 6$	—	ΩpF			
Differential Input Impedance	Z_{DIFF}	—	$10^{13} 3$	—	ΩpF			
Input Common Mode Voltage (V_{CM} or V_{REF}) (Note 4)								
Input Voltage Range	V_{IVL}	—	—	$V_{SS} - 0.2$	V	all	(Note 5, Note 6)	
	V_{IVH}	$V_{DD} + 0.15$	—	—	V			
Common Mode Rejection Ratio	CMRR	62	79	—	dB	1	$V_{CM} = V_{IVL}$ to V_{IVH} , $V_{DD} = 1.8\text{V}$	
		69	87	—	dB	2		
		75	101	—	dB	5		
		79	107	—	dB	10		
		86	119	—	dB	100		
		70	94	—	dB	1	$V_{CM} = V_{IVL}$ to V_{IVH} , $V_{DD} = 5.5\text{V}$	
		78	100	—	dB	2		
		80	108	—	dB	5		
		81	114	—	dB	10		
		88	115	—	dB	100		
Common Mode Non-Linearity	INL_{CM}	-1000	± 115	+1000	ppm	1	$V_{CM} = V_{IVL}$ to V_{IVH} , $V_{DM} = 0\text{V}$, $V_{DD} = 1.8\text{V}$ (Note 7)	
		-570	± 27	+570	ppm	2		
		-230	± 11	+230	ppm	5		
		-125	± 6	+125	ppm	10		
		-50	± 2	+50	ppm	100		
		-400	± 42	+400	ppm	1	$V_{CM} = V_{IVL}$ to V_{IVH} , $V_{DM} = 0\text{V}$, $V_{DD} = 5.5\text{V}$ (Note 7)	
		-220	± 10	+220	ppm	2		
		-100	± 4	+100	ppm	5		
		-50	± 2	+50	ppm	10		
		-30	± 1	+30	ppm	100		

- Note**
- $V_{CM} = (V_{IP} + V_{IM}) / 2$, $V_{DM} = (V_{IP} - V_{IM})$ and $G_{DM} = 1 + R_F/R_G$.
 - The V_{OS} spec limits include 1/f noise effects.
 - This is the input offset drift without V_{OS} re-calibration; toggle $\overline{\text{EN/CAL}}$ to minimize this effect.
 - These specs apply to both the V_{IP} , V_{IM} input pair (use V_{CM}) and to the V_{REF} , V_{FG} input pair (V_{REF} takes V_{CM} 's place).
 - This spec applies to the V_{IP} , V_{IM} , V_{REF} and V_{FG} pins individually.
 - [Figure 2-11](#) and [Figure 2-19](#) show the V_{IVR} and V_{DMR} variation over temperature.
 - See [Section 1.5 "Explanation of DC Error Specs"](#).

TABLE 1-1: DC ELECTRICAL SPECIFICATIONS (CONTINUED)

Electrical Characteristics: Unless otherwise indicated, $T_A = +25^\circ\text{C}$, $V_{DD} = 1.8\text{V}$ to 5.5V , $V_{SS} = \text{GND}$, $\overline{\text{EN/CAL}} = V_{DD}$, $V_{CM} = V_{DD}/2$, $V_{DM} = 0\text{V}$, $V_{REF} = V_{DD}/2$, $V_L = V_{DD}/2$, $R_L = 10\text{ k}\Omega$ to V_L and $G_{DM} = G_{MIN}$; see [Figure 1-6](#) and [Figure 1-7](#).

Parameters	Sym	Min	Typ	Max	Units	G_{MIN}	Conditions
Input Differential Mode Voltage (V_{DM}) (Note 4)							
Differential Input Voltage Range	V_{DML}	$-2.7/G_{MIN}$	—	—	V	all	$V_{REF} = (V_{DD} - G_{DM}V_{DM})/2$ (Note 6)
	V_{DMH}	—	—	$+2.7/G_{MIN}$	V		
Differential Gain Error	g_E	-1	± 0.13	+1	%		$V_{DM} = V_{DML}$ to V_{DMH} ,
Differential Gain Drift	$\Delta g_E/\Delta T_A$	—	± 0.0006	—	$\%/^\circ\text{C}$		$V_{REF} = (V_{DD} - G_{DM}V_{DM})/2$
Differential Non-Linearity	INL_{DM}	-500	± 30	+500	ppm	1	(Note 7)
		-800	± 40	+800	ppm	2, 5	
		-2000	± 100	+2000	ppm	10, 100	
DC Open-Loop Gain	A_{OL}	61	84	—	dB	1	$V_{DD} = 1.8\text{V}$, $V_{OUT} = 0.2\text{V}$ to 1.6V
		68	90	—	dB	2	
		76	98	—	dB	5	
		78	104	—	dB	10	
		86	116	—	dB	100	
		70	94	—	dB	1	$V_{DD} = 5.5\text{V}$, $V_{OUT} = 0.2\text{V}$ to 5.3V
		77	100	—	dB	2	
		84	108	—	dB	5	
		90	114	—	dB	10	
97	125	—	dB	100			
Output							
Minimum Output Voltage Swing	V_{OL}	—	—	$V_{SS} + 15$	mV	all	$V_{DM} = -V_{DD}/(2G_{DM})$, $V_{DD} = 1.8\text{V}$, $V_{REF} = V_{DD}/2 - 1\text{V}$
		—	—	$V_{SS} + 25$	mV		
Maximum Output Voltage Swing	V_{OH}	$V_{DD} - 15$	—	—	mV		$V_{DM} = V_{DD}/(2G_{DM})$, $V_{DD} = 1.8\text{V}$, $V_{REF} = V_{DD}/2 + 1\text{V}$
		$V_{DD} - 25$	—	—	mV		
Output Short Circuit Current	I_{SC}	—	± 8	—	mA		$V_{DD} = 1.8\text{V}$
		—	± 30	—	mA		$V_{DD} = 5.5\text{V}$
Power Supply							
Supply Voltage	V_{DD}	1.8	—	5.5	V	all	
Quiescent Current per Amplifier	I_Q	0.5	0.8	1.1	mA		$I_O = 0$
POR Trip Voltage	V_{PRL}	1.1	1.4	—	V		
	V_{PRH}	—	1.4	1.7	V		

- Note**
- $V_{CM} = (V_{IP} + V_{IM}) / 2$, $V_{DM} = (V_{IP} - V_{IM})$ and $G_{DM} = 1 + R_F/R_G$
 - The V_{OS} spec limits include 1/f noise effects.
 - This is the input offset drift without V_{OS} re-calibration; toggle $\overline{\text{EN/CAL}}$ to minimize this effect.
 - These specs apply to both the V_{IP} , V_{IM} input pair (use V_{CM}) and to the V_{REF} , V_{FG} input pair (V_{REF} takes V_{CM} 's place).
 - This spec applies to the V_{IP} , V_{IM} , V_{REF} and V_{FG} pins individually.
 - [Figure 2-11](#) and [Figure 2-19](#) show the V_{IVR} and V_{DMR} variation over temperature.
 - See [Section 1.5 "Explanation of DC Error Specs"](#).

MCP6N11

TABLE 1-2: AC ELECTRICAL SPECIFICATIONS

Electrical Characteristics: Unless otherwise indicated, $T_A = 25^\circ\text{C}$, $V_{DD} = 1.8\text{V to } 5.5\text{V}$, $V_{SS} = \text{GND}$, $\text{EN}/\text{CAL} = V_{DD}$, $V_{CM} = V_{DD}/2$, $V_{DM} = 0\text{V}$, $V_{REF} = V_{DD}/2$, $V_L = V_{DD}/2$, $R_L = 10\text{ k}\Omega$ to V_L , $C_L = 60\text{ pF}$ and $G_{DM} = G_{MIN}$; see [Figure 1-6](#) and [Figure 1-7](#).

Parameters	Sym	Min	Typ	Max	Units	G_{MIN}	Conditions
AC Response							
Gain Bandwidth Product	GBWP	—	0.50 G_{MIN}	—	MHz	1 to 10	
		—	35	—	MHz	100	
Phase Margin	PM	—	70	—	°	all	
Open-Loop Output Impedance	R_{OL}	—	0.9	—	k Ω	1 to 10	
		—	0.6	—	k Ω	100	
Power Supply Rejection Ratio	PSRR	—	94	—	dB	all	$f < 10\text{ kHz}$
Common Mode Rejection Ratio	CMRR	—	104	—	dB	1 to 10	$f < 10\text{ kHz}$
		—	94	—	dB	100	$f < 10\text{ kHz}$
Step Response							
Slew Rate	SR	—	3	—	V/ μs	1 to 10	$V_{DD} = 1.8\text{V}$
		—	9	—	V/ μs		$V_{DD} = 5.5\text{V}$
		—	2	—	V/ μs	100	$V_{DD} = 1.8\text{V}$
		—	6	—	V/ μs		$V_{DD} = 5.5\text{V}$
Overdrive Recovery, Input Common Mode	t_{IRC}	—	10	—	μs	all	$V_{CM} = V_{SS} - 1\text{V}$ (or $V_{DD} + 1\text{V}$) to $V_{DD}/2$, $G_{DM}V_{DM} = \pm 0.1\text{V}$, 90% of V_{OUT} change
Overdrive Recovery, Input Differential Mode	t_{IRD}	—	5	—	μs		$V_{DM} = V_{DML} - (0.5\text{V})/G_{MIN}$ (or $V_{DMH} + (0.5\text{V})/G_{MIN}$) to 0V, $V_{REF} = (V_{DD} - G_{DM}V_{DM})/2$, 90% of V_{OUT} change
Overdrive Recovery, Output	t_{OR}	—	8	—	μs		$G_{DM} = 2G_{MIN}$, $G_{DM}V_{DM} = 0.5V_{DD}$ to 0V, $V_{REF} = 0.75V_{DD}$ (or $0.25V_{DD}$), 90% of V_{OUT} change
Noise							
Input Noise Voltage	E_{ni}	—	570/ G_{MIN}	—	μV_{P-P}	1 to 10	$f = 0.1\text{ Hz to } 10\text{ Hz}$
		—	18	—	μV_{P-P}	100	
Input Noise Voltage Density	e_{ni}	—	950/ G_{MIN}	—	nV/ $\sqrt{\text{Hz}}$	1 to 10	$f = 100\text{ kHz}$
		—	35	—	nV/ $\sqrt{\text{Hz}}$	100	
Input Current Noise Density	i_{ni}	—	1	—	fA/ $\sqrt{\text{Hz}}$	all	$f = 1\text{ kHz}$

TABLE 1-3: DIGITAL ELECTRICAL SPECIFICATIONS

Electrical Characteristics: Unless otherwise indicated, $T_A = 25^\circ\text{C}$, $V_{DD} = 1.8\text{V to } 5.5\text{V}$, $V_{SS} = \text{GND}$, $\overline{\text{EN/CAL}} = V_{DD}$, $V_{CM} = V_{DD}/2$, $V_{DM} = 0\text{V}$, $V_{REF} = V_{DD}/2$, $V_L = V_{DD}/2$, $R_L = 10\text{ k}\Omega$ to V_L , $C_L = 60\text{ pF}$ and $G_{DM} = G_{MIN}$; see [Figure 1-6](#) and [Figure 1-7](#).

Parameters	Sym	Min	Typ	Max	Units	G_{MIN}	Conditions
EN/CAL Low Specifications							
EN/CAL Logic Threshold, Low	V_{IL}	V_{SS}	—	$0.2 V_{DD}$	V	all	
EN/CAL Input Current, Low	I_{ENL}	—	-0.1	—	nA		$\overline{\text{EN/CAL}} = 0\text{V}$
GND Current	I_{SS}	-7	-2.5	—	μA		$\overline{\text{EN/CAL}} = 0\text{V}$, $V_{DD} = 5.5\text{V}$
Amplifier Output Leakage	$I_{O(LEAK)}$	—	10	—	nA		$\overline{\text{EN/CAL}} = 0\text{V}$
EN/CAL High Specifications							
EN/CAL Logic Threshold, High	V_{IH}	$0.8 V_{DD}$		V_{DD}	V	all	
EN/CAL Input Current, High	I_{ENH}	—	-0.01	—	nA		$\overline{\text{EN/CAL}} = V_{DD}$
EN/CAL Dynamic Specifications							
EN/CAL Input Hysteresis	V_{HYST}	—	0.2	—	V	all	
EN/CAL Low to Amplifier Output High-Z Turn-off Time	t_{OFF}	—	3	10	μs		$\overline{\text{EN/CAL}} = 0.2V_{DD}$ to $V_{OUT} = 0.1(V_{DD}/2)$, $V_{DM}G_{DM} = 1\text{ V}$, $V_L = 0\text{V}$
EN/CAL High to Amplifier Output On Time	t_{ON}	12	20	28	ms		$\overline{\text{EN/CAL}} = 0.8V_{DD}$ to $V_{OUT} = 0.9(V_{DD}/2)$, $V_{DM}G_{DM} = 1\text{ V}$, $V_L = 0\text{V}$
EN/CAL Low to EN/CAL High low time	t_{ENLH}	100	—	—	μs		Minimum time before externally releasing EN/CAL (Note 1)
Amplifier On to EN/CAL Low Setup Time	t_{ENOL}	—	100	—	μs		
POR Dynamic Specifications							
$V_{DD} \downarrow$ to Output Off	t_{PHL}	—	10	—	μs	all	$V_L = 0\text{V}$, $V_{DD} = 1.8\text{V to } V_{PRL} - 0.1\text{V step}$, 90% of V_{OUT} change
$V_{DD} \uparrow$ to Output On	t_{PLH}	140	250	360	ms		$V_L = 0\text{V}$, $V_{DD} = 0\text{V to } V_{PRH} + 0.1\text{V step}$, 90% of V_{OUT} change

Note 1: For design guidance only; not tested.

TABLE 1-4: TEMPERATURE SPECIFICATIONS

Electrical Characteristics: Unless otherwise indicated, all limits are specified for: $V_{DD} = 1.8\text{V to } 5.5\text{V}$, $V_{SS} = \text{GND}$.

Parameters	Sym	Min	Typ	Max	Units	Conditions
Temperature Ranges						
Specified Temperature Range	T_A	-40	—	+125	$^\circ\text{C}$	
Operating Temperature Range	T_A	-40	—	+125	$^\circ\text{C}$	(Note 1)
Storage Temperature Range	T_A	-65	—	+150	$^\circ\text{C}$	
Thermal Package Resistances						
Thermal Resistance, 8L-SOIC	θ_{JA}	—	150	—	$^\circ\text{C/W}$	
Thermal Resistance, 8L-TDFN (2x3)	θ_{JA}	—	53	—	$^\circ\text{C/W}$	

Note 1: Operation must not cause T_J to exceed the Absolute Maximum Junction Temperature specification (+150 $^\circ\text{C}$).

MCP6N11

1.3 Timing Diagrams



FIGURE 1-1: Common Mode Input Overdrive Recovery Timing Diagram.



FIGURE 1-2: Differential Mode Input Overdrive Recovery Timing Diagram.



FIGURE 1-3: Output Overdrive Recovery Timing Diagram.



FIGURE 1-4: POR Timing Diagram.



FIGURE 1-5: EN/CAL Timing Diagram.

1.4 DC Test Circuits

1.4.1 INPUT OFFSET TEST CIRCUIT

Figure 1-6 is used for testing the INA's input offset errors and input voltage range (V_E , V_{IVL} and V_{IVH} ; see Section 1.5.1 "Input Offset Related Errors" and Section 1.5.2 "Input Offset Common Mode Non-linearity"). U_2 is part of a control loop that forces V_{OUT} to equal V_{CNT} ; U_1 can be set to any bias point.



FIGURE 1-6: Test Circuit for Common Mode (Input Offset).

When MCP6N11 is in its normal range of operation, the DC output voltages are (where V_E is the sum of input offset errors and g_E is the gain error):

EQUATION 1-1:

$$\begin{aligned} G_{DM} &= 1 + R_F/R_G \\ V_{OUT} &= V_{CNT} \\ V_M &= V_{REF} + G_{DM}(1 + g_E)V_E \end{aligned}$$

Table 1-5 gives the recommended R_F and R_G values for different G_{MIN} options.

TABLE 1-5: SELECTING R_F AND R_G

G_{MIN} (V/V) Nom.	R_F (Ω) Nom.	R_G (Ω) Nom.	G_{DM} (V/V) Nom.	$G_{DM}V_{OS}$ ($\pm V$) Max.	BW (kHz) Nom.
1	100k	499	201.4	0.60	2.5
2				0.40	5.0
5	100k	100	1001	0.85	2.5
10				0.50	5.0
100				0.35	35

1.4.2 DIFFERENTIAL GAIN TEST CIRCUIT

Figure 1-7 is used for testing the INA's differential gain error, non-linearity and input voltage range (g_E , INL_{DM} , V_{DML} and V_{DMH} ; see Section 1.5.3 "Differential Gain Error and Non-linearity"). R_F and R_G are 0.01% for accurate gain error measurements.



FIGURE 1-7: Test Circuit for Differential Mode.

The output voltages are (where V_E is the sum of input offset errors and g_E is the gain error):

EQUATION 1-2:

$$\begin{aligned} G_{DM} &= 1 + R_F/R_G \\ V_{OUT} &= V_{REF} + G_{DM}(1 + g_E)(V_{DM} + V_E) \\ V_M &= V_{OUT} - V_{REF} \\ &= G_{DM}(1 + g_E)(V_{DM} + V_E) \end{aligned}$$

To keep V_{REF} , V_{FG} and V_{OUT} within their ranges, set:

EQUATION 1-3:

$$V_{REF} = (V_{DD} - G_{DM}V_{DM})/2$$

Table 1-6 shows the recommended R_F and R_G . They produce a 10 k Ω load; V_L can usually be left open.

TABLE 1-6: SELECTING R_F AND R_G

G_{MIN} (V/V) Nom.	R_F (Ω) Nom.	R_G (Ω) Nom.	G_{DM} (V/V) Nom.
1	0	Open	1.000
2	4.99k	4.99k	2.000
5	8.06k	2.00k	5.030
10	9.09k	1.00k	10.09
100	10.0k	100	101.0

MCP6N11

1.5 Explanation of DC Error Specs

1.5.1 INPUT OFFSET RELATED ERRORS

The input offset error (V_E) is extracted from input offset measurements (see [Section 1.4.1 “Input Offset Test Circuit”](#)), based on [Equation 1-1](#):

EQUATION 1-4:

$$V_E = \frac{V_M - V_{REF}}{G_{DM}(1 + g_E)}$$

V_E has several terms, which assume a linear response to changes in V_{DD} , V_{SS} , V_{CM} , V_{OUT} and T_A (all of which are in their specified ranges):

EQUATION 1-5:

$$V_E = V_{OS} + \frac{\Delta V_{DD} - \Delta V_{SS}}{PSRR} + \frac{\Delta V_{CM}}{CMRR} + \frac{\Delta V_{REF}}{CMRR} + \frac{\Delta V_{OUT}}{A_{OL}} + \Delta T_A \cdot \frac{\Delta V_{OS}}{\Delta T_A}$$

Where:

$PSRR$, $CMRR$ and A_{OL} are in units of V/V

ΔT_A is in units of $^{\circ}C$

$V_{DM} = 0$

[Equation 1-2](#) shows how V_E affects V_{OUT} .

1.5.2 INPUT OFFSET COMMON MODE NON-LINEARITY

The input offset error (V_E) changes non-linearly with V_{CM} . [Figure 1-8](#) shows V_E vs. V_{CM} , as well as a linear fit line (V_{E_LIN}) based on V_{OS} and $CMRR$. The op amp is in standard conditions ($\Delta V_{OUT} = 0$, $V_{DM} = 0$, etc.). V_{CM} is swept from V_{IVL} to V_{IVH} . The test circuit is in [Section 1.4.1 “Input Offset Test Circuit”](#) and V_E is calculated using [Equation 1-4](#).

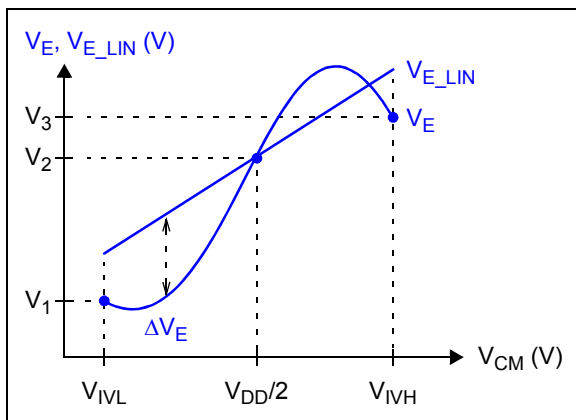

FIGURE 1-8: Input Offset Error vs. Common Mode Input Voltage.

Based on the measured V_E data, we obtain the following linear fit:

EQUATION 1-6:

$$V_{E_LIN} = V_{OS} + \frac{V_{CM} - V_{DD}/2}{CMRR}$$

Where:

$$V_{OS} = V_2$$

$$\frac{1}{CMRR} = \frac{V_3 - V_1}{V_{IVH} - V_{IVL}}$$

The remaining error (ΔV_E) is described by the Common Mode Non-Linearity spec:

EQUATION 1-7:

$$INL_{CM} = \frac{\max|\Delta V_E|}{V_{IVH} - V_{IVL}}$$

Where:

$$\Delta V_E = V_E - V_{E_LIN}$$

The same common mode behavior applies to V_E when V_{REF} is swept, instead of V_{CM} , since both input stages are designed the same:

EQUATION 1-8:

$$V_{E_LIN} = V_{OS} + \frac{V_{REF} - V_{DD}/2}{CMRR}$$

$$INL_{CM} = \frac{\max|\Delta V_E|}{V_{IVH} - V_{IVL}}$$

1.5.3 DIFFERENTIAL GAIN ERROR AND NON-LINEARITY

The differential errors are extracted from differential gain measurements (see [Section 1.4.2 “Differential Gain Test Circuit”](#)), based on [Equation 1-2](#). These errors are the differential gain error (g_E) and the input offset error (V_E , which changes non-linearly with V_{DM}):

EQUATION 1-9:

$$G_{DM} = 1 + R_F/R_G$$

$$V_M = G_{DM}(1 + g_E)(V_{DM} + V_E)$$

These errors are adjusted for the expected output, then referred back to the input, giving the differential input error (V_{ED}) as a function of V_{DM} :

EQUATION 1-10:

$$V_{ED} = \frac{V_M}{G_{DM}} - V_{DM}$$

Figure 1-9 shows V_{ED} vs. V_{DM} , as well as a linear fit line (V_{ED_LIN}) based on V_E and g_E . The op amp is in standard conditions ($\Delta V_{OUT} = 0$, etc.). V_{DM} is swept from V_{DML} to V_{DMH} .



FIGURE 1-9: Differential Input Error vs. Differential Input Voltage.

Based on the measured V_{ED} data, we obtain the following linear fit:

EQUATION 1-11:

$$V_{ED_LIN} = (I + g_E)V_E + g_E V_{DM}$$

Where:

$$g_E = \frac{V_3 - V_1}{V_{DMH} - V_{DML}} - I$$

$$V_E = \frac{V_2}{I + g_E}$$

Note that the V_E value measured here is not as accurate as the one obtained in [Section 1.5.1 “Input Offset Related Errors”](#).

The remaining error (ΔV_{ED}) is described by the Differential Mode Non-Linearity spec:

EQUATION 1-12:

$$INL_{DM} = \frac{\max|\Delta V_{ED}|}{V_{DMH} - V_{DML}}$$

Where:

$$\Delta V_{ED} = V_{ED} - V_{ED_LIN}$$

MCP6N11

NOTES:

2.0 TYPICAL PERFORMANCE CURVES

Note: The graphs and tables provided following this note are a statistical summary based on a limited number of samples and are provided for informational purposes only. The performance characteristics listed herein are not tested or guaranteed. In some graphs or tables, the data presented may be outside the specified operating range (e.g., outside specified power supply range) and therefore outside the warranted range.

Note: Unless otherwise indicated, $T_A = +25^\circ\text{C}$, $V_{DD} = 1.8\text{V}$ to 5.5V , $V_{SS} = \text{GND}$, $\overline{\text{EN/CAL}} = V_{DD}$, $V_{CM} = V_{DD}/2$, $V_{DM} = 0\text{V}$, $V_{REF} = V_{DD}/2$, $V_L = V_{DD}/2$, $R_L = 10\text{ k}\Omega$ to V_L , $C_L = 60\text{ pF}$ and $G_{DM} = G_{MIN}$; see [Figure 1-6](#) and [Figure 1-7](#).

2.1 DC Voltages and Currents



FIGURE 2-1: Normalized Input Offset Voltage, with $G_{MIN} = 1$ to 10 .



FIGURE 2-3: Normalized Input Offset Voltage Drift, with $G_{MIN} = 1$ to 10 .



FIGURE 2-2: Normalized Input Offset Voltage, with $G_{MIN} = 100$.



FIGURE 2-4: Normalized Input Offset Voltage Drift, with $G_{MIN} = 100$.

MCP6N11

Note: Unless otherwise indicated, $T_A = +25^\circ\text{C}$, $V_{DD} = 1.8\text{V}$ to 5.5V , $V_{SS} = \text{GND}$, $\overline{\text{EN/CAL}} = V_{DD}$, $V_{CM} = V_{DD}/2$, $V_{DM} = 0\text{V}$, $V_{REF} = V_{DD}/2$, $V_L = V_{DD}/2$, $R_L = 10\text{ k}\Omega$ to V_L , $C_L = 60\text{ pF}$ and $G_{DM} = G_{MIN}$; see [Figure 1-6](#) and [Figure 1-7](#).



FIGURE 2-5: Normalized Input Offset Voltage vs. Power Supply Voltage, with $V_{CM} = 0\text{V}$ and $G_{MIN} = 1$ to 10 .

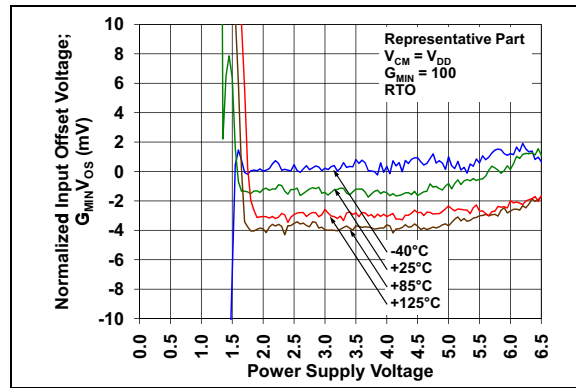

FIGURE 2-8: Normalized Input Offset Voltage vs. Power Supply Voltage, with $V_{CM} = V_{DD}$ and $G_{MIN} = 100$.



FIGURE 2-6: Normalized Input Offset Voltage vs. Power Supply Voltage, with $V_{CM} = 0\text{V}$ and $G_{MIN} = 100$.

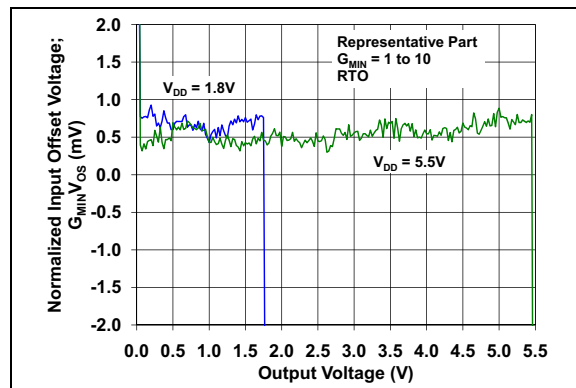

FIGURE 2-9: Normalized Input Offset Voltage vs. Output Voltage, with $G_{MIN} = 1$ to 10 .



FIGURE 2-7: Normalized Input Offset Voltage vs. Power Supply Voltage, with $V_{CM} = V_{DD}$ and $G_{MIN} = 1$ to 10 .

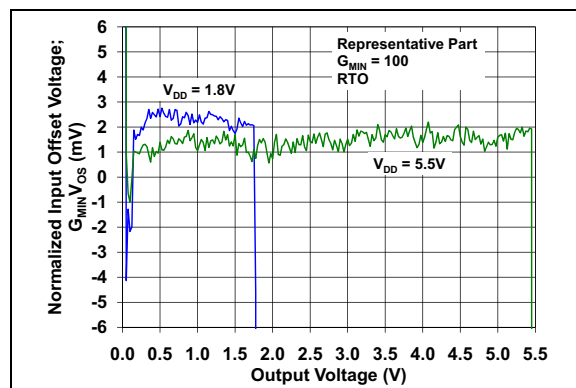

FIGURE 2-10: Normalized Input Offset Voltage vs. Output Voltage, with $G_{MIN} = 100$.

Note: Unless otherwise indicated, $T_A = +25^\circ\text{C}$, $V_{DD} = 1.8\text{V}$ to 5.5V , $V_{SS} = \text{GND}$, $\overline{\text{EN/CAL}} = V_{DD}$, $V_{CM} = V_{DD}/2$, $V_{DM} = 0\text{V}$, $V_{REF} = V_{DD}/2$, $V_L = V_{DD}/2$, $R_L = 10\text{ k}\Omega$ to V_L , $C_L = 60\text{ pF}$ and $G_{DM} = G_{MIN}$; see Figure 1-6 and Figure 1-7.



FIGURE 2-11: Input Common Mode Voltage Headroom vs. Ambient Temperature.



FIGURE 2-14: Normalized Input Offset Voltage vs. Common Mode Voltage, with $V_{DD} = 5.5\text{V}$ and $G_{MIN} = 1$ to 10 .

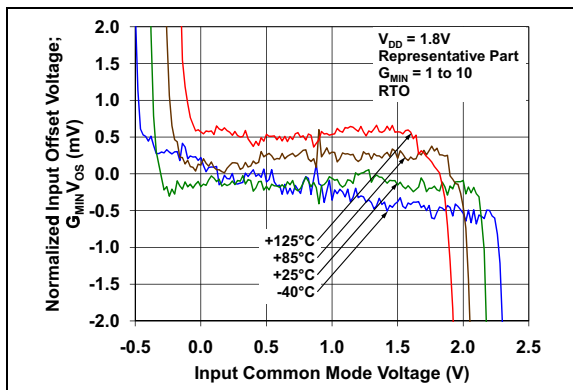

FIGURE 2-12: Normalized Input Offset Voltage vs. Common Mode Voltage, with $V_{DD} = 1.8\text{V}$ and $G_{MIN} = 1$ to 10 .

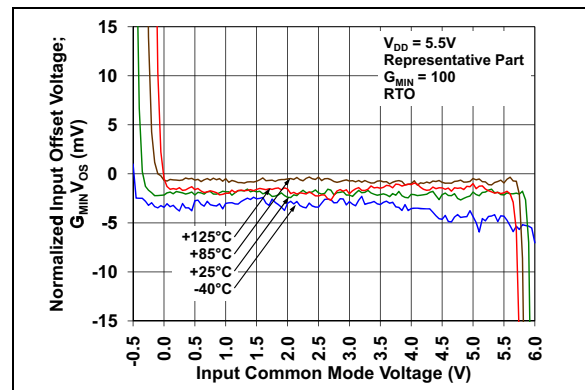

FIGURE 2-15: Normalized Input Offset Voltage vs. Common Mode Voltage, with $V_{DD} = 5.5\text{V}$ and $G_{MIN} = 100$.

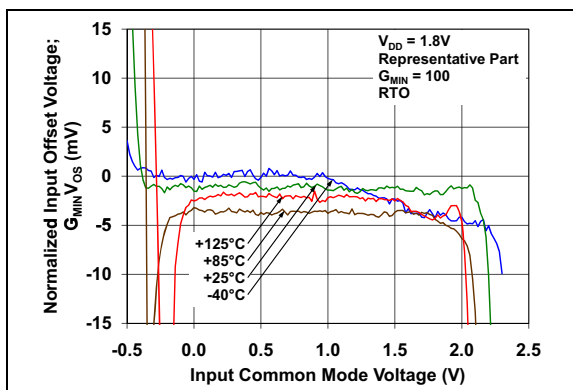

FIGURE 2-13: Normalized Input Offset Voltage vs. Common Mode Voltage, with $V_{DD} = 1.8\text{V}$ and $G_{MIN} = 100$.

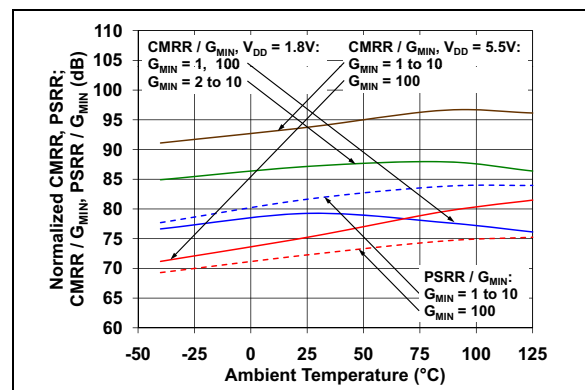

FIGURE 2-16: Normalized CMRR and PSRR vs. Ambient Temperature.

MCP6N11

Note: Unless otherwise indicated, $T_A = +25^\circ\text{C}$, $V_{DD} = 1.8\text{V}$ to 5.5V , $V_{SS} = \text{GND}$, $\overline{\text{EN/CAL}} = V_{DD}$, $V_{CM} = V_{DD}/2$, $V_{DM} = 0\text{V}$, $V_{REF} = V_{DD}/2$, $V_L = V_{DD}/2$, $R_L = 10\text{ k}\Omega$ to V_L , $C_L = 60\text{ pF}$ and $G_{DM} = G_{MIN}$; see Figure 1-6 and Figure 1-7.



FIGURE 2-17: Normalized DC Open-Loop Gain vs. Ambient Temperature.

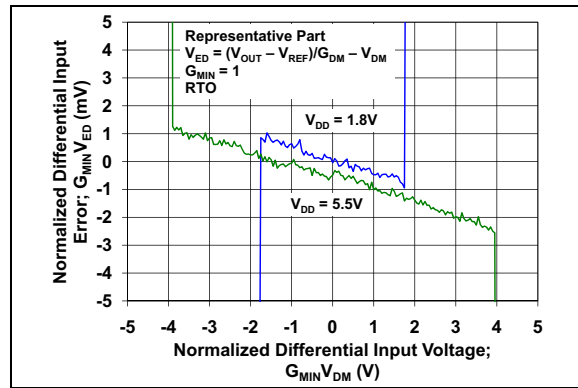

FIGURE 2-20: Normalized Differential Input Error vs. Differential Voltage, with $G_{MIN} = 1$.



FIGURE 2-18: The MCP6N11 Shows No Phase Reversal vs. Common Mode Voltage.

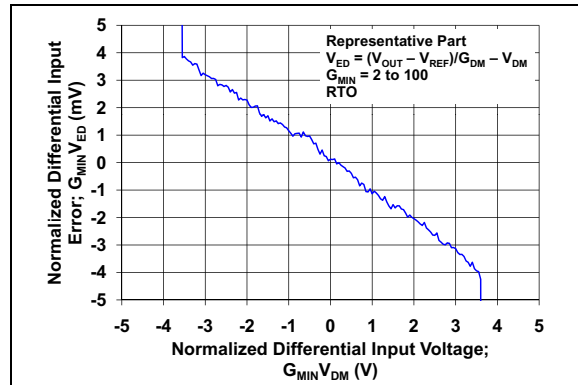

FIGURE 2-21: Normalized Differential Input Error vs. Differential Voltage, with $G_{MIN} = 2$ to 100 .



FIGURE 2-19: Normalized Differential Mode Voltage Range vs. Ambient Temperature.



FIGURE 2-22: The MCP6N11 Shows No Phase Reversal vs. Differential Voltage, with $V_{DD} = 5.5\text{V}$.

Note: Unless otherwise indicated, $T_A = +25^\circ\text{C}$, $V_{DD} = 1.8\text{V}$ to 5.5V , $V_{SS} = \text{GND}$, $\overline{\text{EN/CAL}} = V_{DD}$, $V_{CM} = V_{DD}/2$, $V_{DM} = 0\text{V}$, $V_{REF} = V_{DD}/2$, $V_L = V_{DD}/2$, $R_L = 10\text{ k}\Omega$ to V_L , $C_L = 60\text{ pF}$ and $G_{DM} = G_{MIN}$; see Figure 1-6 and Figure 1-7.



FIGURE 2-23: Input Bias and Offset Currents vs. Ambient Temperature, with $V_{DD} = +5.5\text{V}$.



FIGURE 2-26: Input Bias and Offset Currents vs. Common Mode Input Voltage, with $T_A = +125^\circ\text{C}$.



FIGURE 2-24: Input Bias Current vs. Input Voltage (below V_{SS}).



FIGURE 2-27: Output Voltage Headroom vs. Output Current.



FIGURE 2-25: Input Bias and Offset Currents vs. Common Mode Input Voltage, with $T_A = +85^\circ\text{C}$.



FIGURE 2-28: Output Voltage Headroom vs. Ambient Temperature.

MCP6N11

Note: Unless otherwise indicated, $T_A = +25^\circ\text{C}$, $V_{DD} = 1.8\text{V}$ to 5.5V , $V_{SS} = \text{GND}$, $\overline{\text{EN/CAL}} = V_{DD}$, $V_{CM} = V_{DD}/2$, $V_{DM} = 0\text{V}$, $V_{REF} = V_{DD}/2$, $V_L = V_{DD}/2$, $R_L = 10\text{ k}\Omega$ to V_L , $C_L = 60\text{ pF}$ and $G_{DM} = G_{MIN}$; see [Figure 1-6](#) and [Figure 1-7](#).



FIGURE 2-29: Output Short Circuit Current vs. Power Supply Voltage.



FIGURE 2-31: Supply Current vs. Common Mode Input Voltage.



FIGURE 2-30: Supply Current vs. Power Supply Voltage.

Note: Unless otherwise indicated, $T_A = +25^\circ\text{C}$, $V_{DD} = 1.8\text{V}$ to 5.5V , $V_{SS} = \text{GND}$, $\overline{\text{EN/CAL}} = V_{DD}$, $V_{CM} = V_{DD}/2$, $V_{DM} = 0\text{V}$, $V_{REF} = V_{DD}/2$, $V_L = V_{DD}/2$, $R_L = 10\text{ k}\Omega$ to V_L , $C_L = 60\text{ pF}$ and $G_{DM} = G_{MIN}$; see Figure 1-6 and Figure 1-7.

2.2 Frequency Response

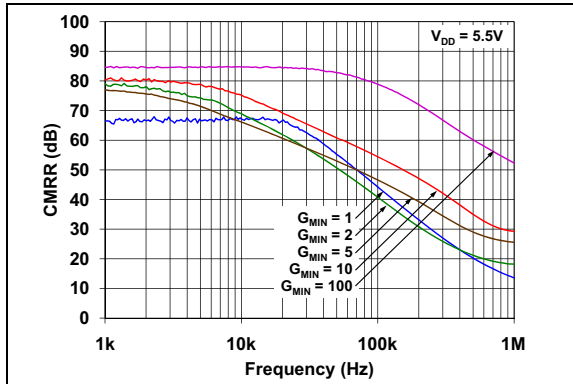

FIGURE 2-32: CMRR vs. Frequency.

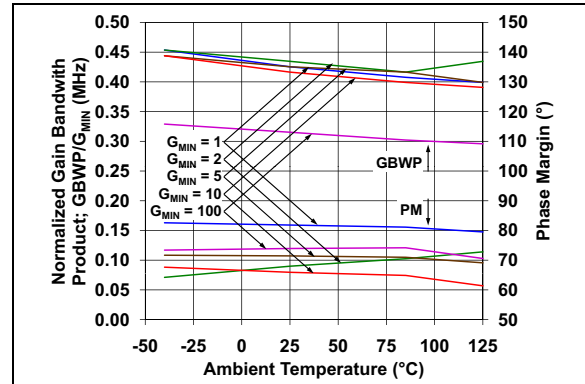

FIGURE 2-35: Normalized Gain Bandwidth Product and Phase Margin vs. Ambient Temperature.



FIGURE 2-33: PSRR vs. Frequency.



FIGURE 2-36: Closed-Loop Output Impedance vs. Frequency.



FIGURE 2-34: Normalized Open-Loop Gain vs. Frequency.



FIGURE 2-37: Gain Peaking vs. Normalized Capacitive Load.

MCP6N11

Note: Unless otherwise indicated, $T_A = +25^\circ\text{C}$, $V_{DD} = 1.8\text{V}$ to 5.5V , $V_{SS} = \text{GND}$, $\overline{\text{EN/CAL}} = V_{DD}$, $V_{CM} = V_{DD}/2$, $V_{DM} = 0\text{V}$, $V_{REF} = V_{DD}/2$, $V_L = V_{DD}/2$, $R_L = 10\text{ k}\Omega$ to V_L , $C_L = 60\text{ pF}$ and $G_{DM} = G_{MIN}$; see Figure 1-6 and Figure 1-7.

2.3 Noise

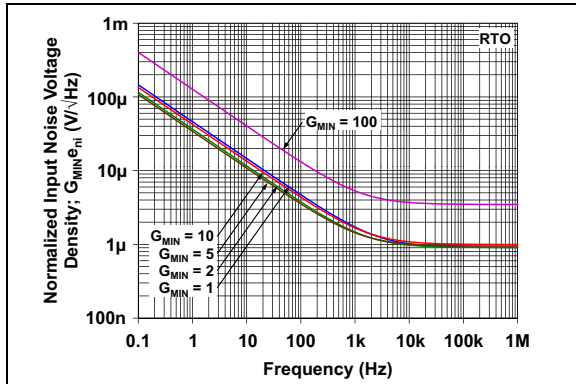

FIGURE 2-38: Normalized Input Noise Voltage Density vs. Frequency.

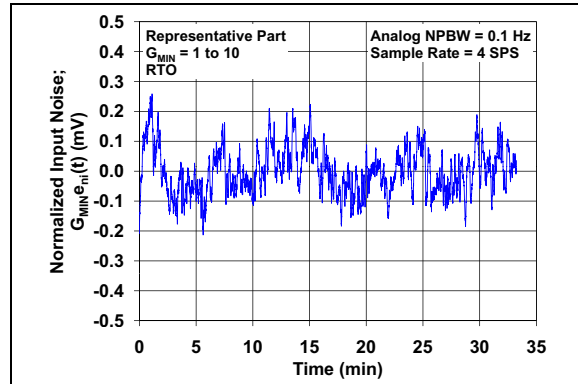

FIGURE 2-41: Normalized Input Noise Voltage vs. Time, with $G_{MIN} = 1$ to 10 .

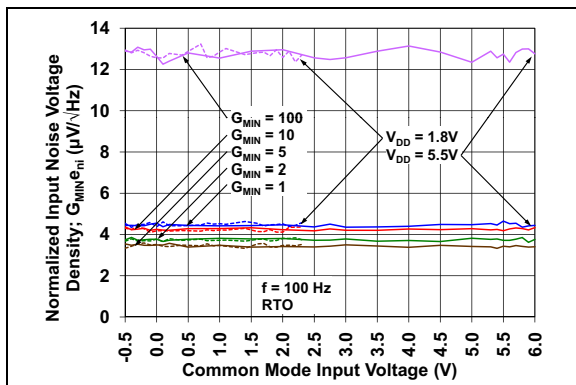

FIGURE 2-39: Normalized Input Noise Voltage Density vs. Input Common Mode Voltage, with $f = 100\text{ Hz}$.

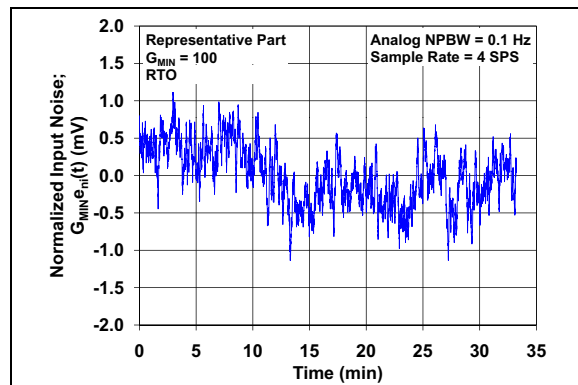

FIGURE 2-42: Normalized Input Noise Voltage vs. Time, with $G_{MIN} = 100$.

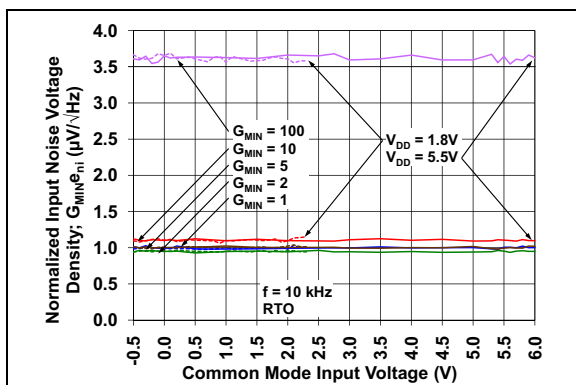

FIGURE 2-40: Normalized Input Noise Voltage Density vs. Input Common Mode Voltage, with $f = 10\text{ kHz}$.

Note: Unless otherwise indicated, $T_A = +25^\circ\text{C}$, $V_{DD} = 1.8\text{V}$ to 5.5V , $V_{SS} = \text{GND}$, $\text{EN}/\overline{\text{CAL}} = V_{DD}$, $V_{CM} = V_{DD}/2$, $V_{DM} = 0\text{V}$, $V_{REF} = V_{DD}/2$, $V_L = V_{DD}/2$, $R_L = 10\text{ k}\Omega$ to V_L , $C_L = 60\text{ pF}$ and $G_{DM} = G_{MIN}$; see [Figure 1-6](#) and [Figure 1-7](#).

2.4 Time Response



FIGURE 2-43: Small Signal Step Response.



FIGURE 2-46: Maximum Output Voltage Swing vs. Frequency.



FIGURE 2-44: Large Signal Step Response.



FIGURE 2-47: Common Mode Input Overdrive Recovery Time vs. Normalized Gain.



FIGURE 2-45: Slew Rate vs. Ambient Temperature.



FIGURE 2-48: Differential Input Overdrive Recovery Time vs. Normalized Gain.

MCP6N11

Note: Unless otherwise indicated, $T_A = +25^\circ\text{C}$, $V_{DD} = 1.8\text{V}$ to 5.5V , $V_{SS} = \text{GND}$, $\overline{\text{EN/CAL}} = V_{DD}$, $V_{CM} = V_{DD}/2$, $V_{DM} = 0\text{V}$, $V_{REF} = V_{DD}/2$, $V_L = V_{DD}/2$, $R_L = 10\text{ k}\Omega$ to V_L , $C_L = 60\text{ pF}$ and $G_{DM} = G_{MIN}$; see Figure 1-6 and Figure 1-7.



FIGURE 2-49: Output Overdrive Recovery Time vs. Normalized Gain.



FIGURE 2-51: The MCP6N11 Shows No Phase Reversal vs. Differential Input Overdrive, with $V_{DD} = 5.5\text{V}$.



FIGURE 2-50: The MCP6N11 Shows No Phase Reversal vs. Common Mode Input Overdrive, with $V_{DD} = 5.5\text{V}$.

Note: Unless otherwise indicated, $T_A = +25^\circ\text{C}$, $V_{DD} = 1.8\text{V}$ to 5.5V , $V_{SS} = \text{GND}$, $\overline{\text{EN/CAL}} = V_{DD}$, $V_{CM} = V_{DD}/2$, $V_{DM} = 0\text{V}$, $V_{REF} = V_{DD}/2$, $V_L = V_{DD}/2$, $R_L = 10\text{ k}\Omega$ to V_L , $C_L = 60\text{ pF}$ and $G_{DM} = G_{MIN}$; see [Figure 1-6](#) and [Figure 1-7](#).

2.5 Enable/Calibration and POR Responses

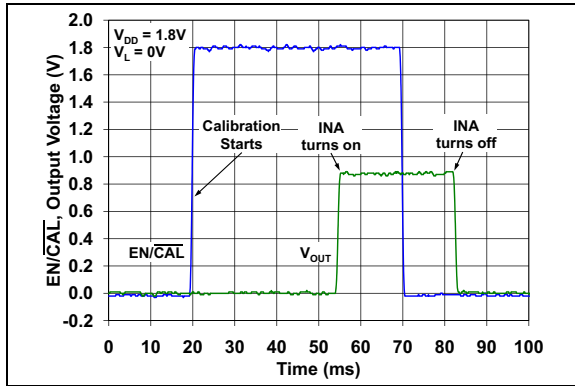

FIGURE 2-52: $\overline{\text{EN/CAL}}$ and Output Voltage vs. Time, with $V_{DD} = 1.8\text{V}$.

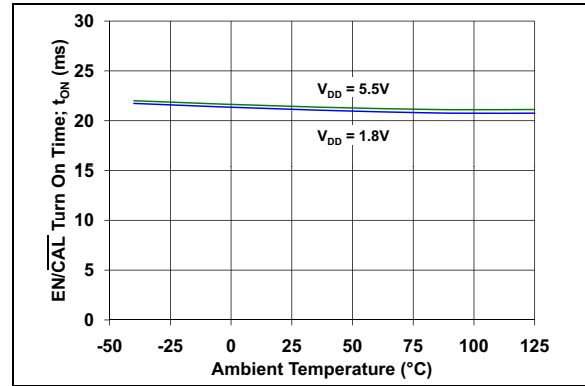

FIGURE 2-55: $\overline{\text{EN/CAL}}$ Turn On Time vs. Ambient Temperature.

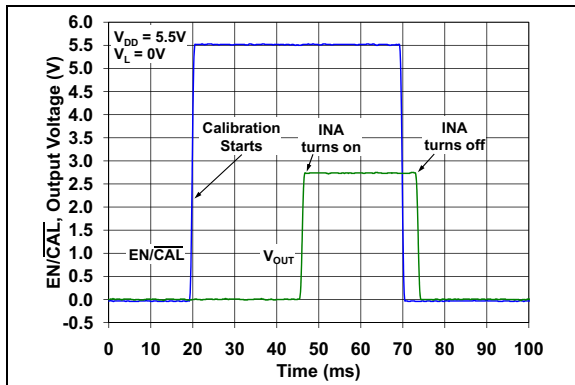

FIGURE 2-53: $\overline{\text{EN/CAL}}$ and Output Voltage vs. Time, with $V_{DD} = 5.5\text{V}$

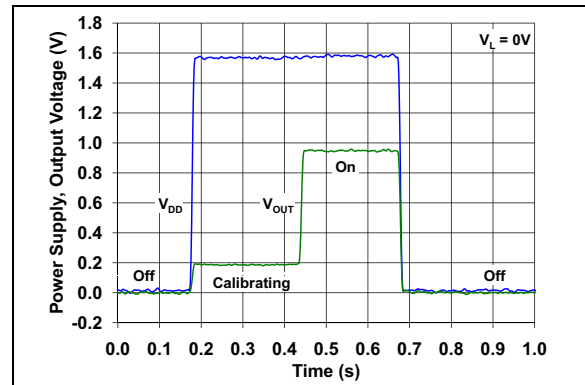

FIGURE 2-56: Power Supply On and Off and Output Voltage vs. Time.



FIGURE 2-54: $\overline{\text{EN/CAL}}$ Hysteresis vs. Ambient Temperature.

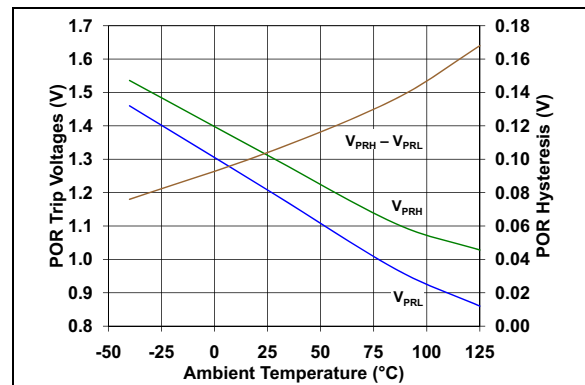

FIGURE 2-57: POR Trip Voltages and Hysteresis vs. Temperature.

MCP6N11

Note: Unless otherwise indicated, $T_A = +25^\circ\text{C}$, $V_{DD} = 1.8\text{V}$ to 5.5V , $V_{SS} = \text{GND}$, $\overline{\text{EN/CAL}} = V_{DD}$, $V_{CM} = V_{DD}/2$, $V_{DM} = 0\text{V}$, $V_{REF} = V_{DD}/2$, $V_L = V_{DD}/2$, $R_L = 10\text{ k}\Omega$ to V_L , $C_L = 60\text{ pF}$ and $G_{DM} = G_{MIN}$; see [Figure 1-6](#) and [Figure 1-7](#).

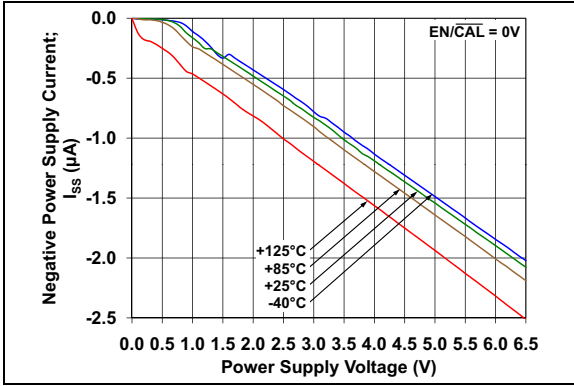

FIGURE 2-58: Quiescent Current in Shutdown vs. Power Supply Voltage.

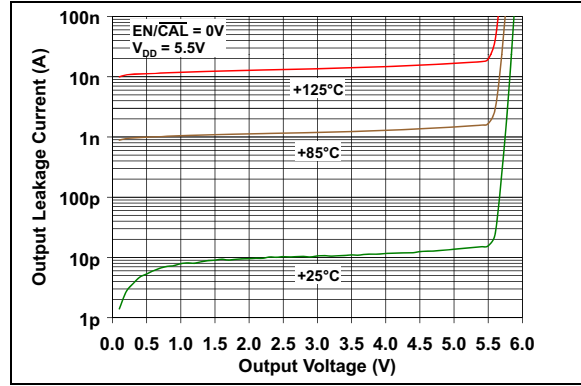

FIGURE 2-59: Output Leakage Current vs. Output Voltage.

3.0 PIN DESCRIPTIONS

Descriptions of the pins are listed in [Table 3-1](#).

TABLE 3-1: PIN FUNCTION TABLE

MCP6N11		Symbol	Description
SOIC	TDFN		
1	1	V_{FG}	Feedback Input
2	2	V_{IM}	Inverting Input
3	3	V_{IP}	Non-inverting Input
4	4	V_{SS}	Negative Power Supply
5	5	V_{REF}	Reference Input
6	6	V_{OUT}	Output
7	7	V_{DD}	Positive Power Supply
8	8	EN/\overline{CAL}	Enable/ V_{OS} Calibrate Digital Input
—	9	EP	Exposed Thermal Pad (EP); must be connected to V_{SS}

3.1 Analog Signal Inputs

The non-inverting and inverting inputs (V_{IP} and V_{IM}) are high-impedance CMOS inputs with low bias currents.

3.2 Analog Feedback Input

The analog feedback input (V_{FG}) is the inverting input of the second input stage. The external feedback components (R_F and R_G) are connected to this pin. It is a high-impedance CMOS input with low bias current.

3.3 Analog Reference Input

The analog reference input (V_{REF}) is the non-inverting input of the second input stage; it shifts V_{OUT} to its desired range. The external gain resistor (R_G) is connected to this pin. It is a high-impedance CMOS input with low bias current.

3.4 Analog Output

The analog output (V_{OUT}) is a low-impedance voltage output. It represents the differential input voltage ($V_{DM} = V_{IP} - V_{IM}$), with gain G_{DM} and is shifted by V_{REF} . The external feedback resistor (R_F) is connected to this pin.

3.5 Power Supply Pins

The positive power supply (V_{DD}) is 1.8V to 5.5V higher than the negative power supply (V_{SS}). For normal operation, the other pins are between V_{SS} and V_{DD} .

Typically, these parts are used in a single (positive) supply configuration. In this case, V_{SS} is connected to ground and V_{DD} is connected to the supply; V_{DD} will need bypass capacitors.

3.6 Digital Enable and V_{OS} Calibration Input

This input (EN/\overline{CAL}) is a CMOS, Schmitt-triggered input that controls the active, low power and V_{OS} calibration modes of operation. When this pin goes low, the part is placed into a low power mode and the output is high-Z. When this pin goes high, the amplifier's input offset voltage is corrected by the calibration circuitry, then the output is re-connected to the V_{OUT} pin, which becomes low impedance, and the part resumes normal operation.

3.7 Exposed Thermal Pad (EP)

There is an internal connection between the Exposed Thermal Pad (EP) and the V_{SS} pin; they must be connected to the same potential on the Printed Circuit Board (PCB).

This pad can be connected to a PCB ground plane to provide a larger heat sink. This improves the package thermal resistance (θ_{JA}).

MCP6N11

NOTES:

4.0 APPLICATIONS

The MCP6N11 instrumentation amplifier (INA) is manufactured using Microchip's state of the art CMOS process. It is low cost, low power and high speed, making it ideal for battery-powered applications.

4.1 Basic Performance

4.1.1 STANDARD CIRCUIT

Figure 4-1 shows the standard circuit configuration for these INAs. When the inputs and output are in their specified ranges, the output voltage is approximately:

EQUATION 4-1:

$$V_{OUT} \approx V_{REF} + G_{DM}V_{DM}$$

Where:

$$G_{DM} = 1 + R_F / R_G$$



FIGURE 4-1: Standard Circuit.

For normal operation, keep:

- V_{IP} , V_{IM} , V_{REF} and V_{FG} between V_{IVL} and V_{IVH}
- $V_{IP} - V_{IM}$ (i.e., V_{DM}) between V_{DML} and V_{DMH}
- V_{OUT} between V_{OL} and V_{OH}

4.1.2 ARCHITECTURE

Figure 4-2 shows the block diagram for these INAs.

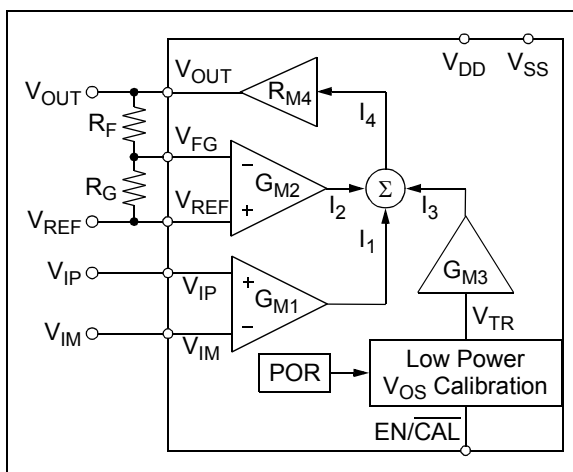

FIGURE 4-2: MCP6N11 Block Diagram.

The input offset voltage (V_{OS}) is corrected by the voltage V_{TR} . Each time a V_{OS} Calibration event occurs, V_{TR} is updated to the best value (at that moment). These events are triggered by either powering up (monitored by the POR) or by toggling the EN/CAL pin high. The current out of G_{M3} (I_3) is constant and very small (assumed to be zero in the following discussion).

The input signal is applied to G_{M1} . Equation 4-2 shows the relationships between the input voltages (V_{IP} and V_{IM}) and the common mode and differential voltages (V_{CM} and V_{DM}).

EQUATION 4-2:

$$V_{IP} = V_{CM} + V_{DM}/2$$

$$V_{IM} = V_{CM} - V_{DM}/2$$

$$V_{CM} = (V_{IP} + V_{IM})/2$$

$$V_{DM} = V_{IP} - V_{IM}$$

The negative feedback loop includes G_{M2} , R_{M4} , R_F and R_G . These blocks set the DC open-loop gain (A_{OL}) and the nominal differential gain (G_{DM}):

EQUATION 4-3:

$$A_{OL} = G_{M2}R_{M4}$$

$$G_{DM} = 1 + R_F/R_G$$

A_{OL} is very high, so I_4 is very small and $I_1 + I_2 \approx 0$. This makes the differential inputs to G_{M1} and G_{M2} equal in magnitude and opposite in polarity. Ideally, this gives:

EQUATION 4-4:

$$(V_{FG} - V_{REF}) = V_{DM}$$

$$V_{OUT} = V_{DM}G_{DM} + V_{REF}$$

For an ideal part, changing V_{CM} , V_{SS} or V_{DD} produces no change in V_{OUT} . V_{REF} shifts V_{OUT} as needed.

The different G_{MIN} options change G_{M1} , G_{M2} and the internal compensation capacitor. This results in the performance trade-offs shown in Table 1.

MCP6N11

4.1.3 DC ERRORS

Section 1.5 “Explanation of DC Error Specs” defines some of the DC error specifications. These errors are internal to the INA, and can be summarized as follows:

EQUATION 4-5:

$$V_{OUT} = V_{REF} + G_{DM}(I + g_E)(V_{DM} + \Delta V_{ED}) + G_{DM}(I + g_E)(V_E + \Delta V_E)$$

Where:

$$V_E = V_{OS} + \frac{\Delta V_{DD} - \Delta V_{SS}}{PSRR} + \frac{\Delta V_{CM}}{CMRR} + \frac{\Delta V_{REF}}{CMRR} + \frac{\Delta V_{OUT}}{A_{OL}} + \Delta T_A \cdot \frac{\Delta V_{OS}}{\Delta T_A}$$

$$\Delta V_{ED} \leq INL_{DM}(V_{DMH} - V_{DML})$$

$$\Delta V_E \leq INL_{CM}(V_{IVH} - V_{IVL})$$

Where:

$PSRR$, $CMRR$ and A_{OL} are in units of V/V

ΔT_A is in units of °C

The non-linearity specs (INL_{CM} and INL_{DM}) describe errors that are non-linear functions of V_{CM} and V_{DM} , respectively. They give the maximum excursion from linear response over the entire common mode and differential ranges.

The input bias current and offset current specs (I_B and I_{OS}), together with a circuit's external input resistances, give an additional DC error. **Figure 4-3** shows the resistors that set the DC bias point.



FIGURE 4-3: DC Bias Resistors.

The resistors at the main input (R_{IP} and R_{IM}) and its input bias currents (I_{BP} and I_{BM}) give the following changes in the INA's bias voltages:

EQUATION 4-6:

$$\Delta V_{IP} = -I_{BP}R_{IP} = \left(-I_B - \frac{I_{OS}}{2}\right)R_{IP}$$

$$\Delta V_{IM} = -I_{BM}R_{IM} = \left(-I_B + \frac{I_{OS}}{2}\right)R_{IM}$$

$$\Delta V_{CM} = \frac{\Delta V_{IP} + \Delta V_{IM}}{2} = -I_B \left(\frac{R_{IP} + R_{IM}}{2}\right) + \frac{-I_{OS}}{2} \left(\frac{-R_{IP} + R_{IM}}{2}\right)$$

$$\Delta V_{DM} = \Delta V_{IP} - \Delta V_{IM} = I_B(-R_{IP} + R_{IM}) - \frac{I_{OS}}{2}(R_{IP} + R_{IM})$$

$$\Delta V_{OUT} = G_{DM} \left(\Delta V_{DM} + \frac{\Delta V_{CM}}{CMRR}\right)$$

Where:

$CMRR$ is in units of V/V

The best design results when R_{IP} and R_{IM} are equal and small:

EQUATION 4-7:

$$\Delta V_{OUT} \approx G_{DM}\Delta V_{DM} \approx G_{DM}(\pm 2I_B \epsilon_{RTOL} - I_{OS})R_{IP}$$

Where:

$$R_{IP} = R_{IM}$$

$$\epsilon_{RTOL} = \text{tolerance of } R_{IP} \text{ and } R_{IM}$$

The resistors at the feedback input (R_R , R_F and R_G) and its input bias currents (I_{BR} and I_{BF}) give the following changes in the INA's bias voltages:

EQUATION 4-8:

$$\Delta V_{REF} = -I_{BR}R_R = \left(-I_{B2} - \frac{I_{OS2}}{2}\right)R_R$$

$$\Delta V_{FG} \approx \Delta V_{REF}, \quad \text{due to high } A_{OL}$$

$$\Delta V_{OUT} \approx I_{B2}(R_F - G_{DM}R_R) + \frac{I_{OS2}}{2}(R_F + G_{DM}R_R)$$

Where:

$$I_{B2} \text{ meets the } I_B \text{ spec, but is not equal to } I_B$$

$$I_{OS2} \text{ meets the } I_{OS} \text{ spec, but is not equal to } I_{OS}$$

The best design results when $G_{DM}R_R$ and R_F are equal and small:

EQUATION 4-9:

$$\Delta V_{OUT} \approx (\pm(2I_{B2}\epsilon_{RTOL} + I_{OS2}))R_F$$

Where:

$$G_{DM}R_R = R_F$$

$$\epsilon_{RTOL} = \text{tolerance of } R_R, R_F \text{ and } R_G$$

4.1.4 AC PERFORMANCE

The bandwidth of these amplifiers depends on G_{DM} and G_{MIN} :

EQUATION 4-10:

$$f_{BW} \approx \frac{f_{GBWP}}{G_{DM}}$$

$$\approx (0.50 \text{ MHz})(G_{MIN}/G_{DM}), \quad G_{MIN} = 1, \dots, 10$$

$$\approx (0.35 \text{ MHz})(G_{MIN}/G_{DM}), \quad G_{MIN} = 100$$

Where:

f_{BW} = -3 dB bandwidth

f_{GBWP} = Gain bandwidth product

The bandwidth at the maximum output swing is called the Full Power Bandwidth (f_{FPBW}). It is limited by the Slew Rate (SR) for many amplifiers, but is close to f_{BW} for these parts:

EQUATION 4-11:

$$f_{FPBW} \approx \frac{SR}{\pi V_O}$$

$$\approx f_{BW}, \quad \text{for these parts}$$

Where:

V_O = Maximum output voltage swing

$$\approx V_{OH} - V_{OL}$$

CMRR is constant from DC to about 1 kHz.

4.1.5 NOISE PERFORMANCE

As shown in [Figures 2-41](#) and [2-42](#), the $1/f$ noise causes an apparent wander in the DC output voltage. Changing the measurement time or bandwidth has little effect on this noise.

We recommend re-calibrating V_{OS} periodically, to reduce $1/f$ noise wander. For example, V_{OS} could be re-calibrated at least once every 15 minutes; more often when temperature or V_{DD} change significantly.

4.2 Functional Blocks

4.2.1 RAIL-TO-RAIL INPUTS

Each input stage uses one PMOS differential pair at the input. The output of each differential pair is processed using current mode circuitry. The inputs show no crossover distortion vs. common mode voltage.

With this topology, the inputs (V_{IP} and V_{IM}) operate normally down to $V_{SS} - 0.2V$ and up to $V_{DD} + 0.15V$ at room temperature (see [Figure 2-11](#)). The input offset voltage (V_{OS}) is measured at $V_{CM} = V_{SS} - 0.2V$ and $V_{DD} + 0.15V$ (at $+25^\circ C$), to ensure proper operation.

4.2.1.1 Phase Reversal

The input devices are designed to not exhibit phase inversion when the input pins exceed the supply voltages. [Figures 2-18](#) and [2-50](#) show an input voltage exceeding both supplies with no phase inversion.

The input devices also do not exhibit phase inversion when the differential input voltage exceeds its limits; see [Figures 2-22](#) and [2-51](#).

4.2.1.2 Input Voltage Limits

In order to prevent damage and/or improper operation of these amplifiers, the circuit must limit the voltages at the input pins (see [Section 1.1 "Absolute Maximum Ratings †"](#)). This requirement is independent of the current limits discussed later on.

The ESD protection on the inputs can be depicted as shown in [Figure 4-4](#). This structure was chosen to protect the input transistors against many (but not all) overvoltage conditions, and to minimize input bias current (I_B).



FIGURE 4-4: Simplified Analog Input ESD Structures.

MCP6N11

The input ESD diodes clamp the inputs when they try to go more than one diode drop below V_{SS} . They also clamp any voltages that go too far above V_{DD} ; their breakdown voltage is high enough to allow normal operation, but not low enough to protect against slow overvoltage (beyond V_{DD}) events. Very fast ESD events (that meet the spec) are limited so that damage does not occur.

In some applications, it may be necessary to prevent excessive voltages from reaching the op amp inputs. Figure 4-5 shows one approach to protecting these inputs. D_1 and D_2 may be small signal silicon diodes, Schottky diodes for lower clamping voltages or diode-connected FETs for low leakage.



FIGURE 4-5: Protecting the Analog Inputs Against High Voltages.

4.2.1.3 Input Current Limits

In order to prevent damage and/or improper operation of these amplifiers, the circuit must limit the currents into the input pins (see Section 1.1 “Absolute Maximum Ratings †”). This requirement is independent of the voltage limits previously discussed.

Figure 4-6 shows one approach to protecting these inputs. The resistors R_1 and R_2 limit the possible current in or out of the input pins (and into D_1 and D_2). The diode currents will dump onto V_{DD} .



FIGURE 4-6: Protecting the Analog Inputs Against High Currents.

It is also possible to connect the diodes to the left of the resistor R_1 and R_2 . In this case, the currents through the diodes D_1 and D_2 need to be limited by some other mechanism. The resistors then serve as in-rush current limiters; the DC current into the input pins (V_{IP} and V_{IM}) should be very small.

A significant amount of current can flow out of the inputs (through the ESD diodes) when the common mode voltage (V_{CM}) is below ground (V_{SS}); see Figure 2-25.

4.2.1.4 Input Voltage Ranges

Figure 4-7 shows possible input voltage values ($V_{SS} = 0V$). Lines with a slope of +1 have constant V_{DM} (e.g., the $V_{DM} = 0$ line). Lines with a slope of -1 have constant V_{CM} (e.g., the $V_{CM} = V_{DD}/2$ line).

For normal operation, V_{IP} and V_{IM} must be kept within the region surrounded by the thick blue lines. The horizontal and vertical blue lines show the limits on the individual inputs. The blue lines with a slope of +1 show the limits on V_{DM} ; the larger G_{MIN} is, the closer they are to the $V_{DM} = 0$ line.

The input voltage range specs (V_{IVL} and V_{IVH}) change with the supply voltages (V_{SS} and V_{DD} , respectively). The differential input range specs (V_{DML} and V_{DMH}) change with minimum gain (G_{MIN}). Temperature also affects these specs.

To take full advantage of V_{DML} and V_{DMH} , set V_{REF} (see Figure 1-6 and Figure 1-7) so that the output (V_{OUT}) is centered between the supplies (V_{SS} and V_{DD}).



FIGURE 4-7: Input Voltage Ranges.

4.2.2 $\overline{\text{EN/CAL}}$ V_{OS} CALIBRATION (EN/CAL)

These parts have a Normal mode, a Low Power mode and a V_{OS} Calibration mode.

When the $\overline{\text{EN/CAL}}$ pin is high and the internal POR (with delay) indicates that power is good, the part operates in its Normal mode.

When the $\overline{\text{EN/CAL}}$ pin is low, the part operates in its Low Power mode. The quiescent current (at V_{SS}) drops to $-2.5 \mu\text{A}$ (typical), the amplifier output is put into a high-impedance state. Signals at the input pins can feed through to the output pin.

When the $\overline{\text{EN/CAL}}$ pin goes high and the internal POR (with delay) indicates that power is good, the amplifier internally corrects its input offset voltage (V_{OS}) with the internal common mode voltage at mid-supply ($V_{\text{DD}}/2$) and the output tri-stated (after t_{OFF}). Once V_{OS} Calibration is completed, the amplifier is enabled and normal operation resumes.

The $\overline{\text{EN/CAL}}$ pin does not operate normally when left floating. Either drive it with a logic output, or tie it high so that the part is always on.

4.2.3 POR WITH DELAY

The internal POR makes sure that the input offset voltage (V_{OS}) is calibrated whenever the supply voltage goes from low voltage ($< V_{\text{PRL}}$) to high voltage ($> V_{\text{PRH}}$). This prevents corruption of the V_{OS} trim registers after a low-power event.

After the POR goes high, the internal circuitry adds a fixed delay (t_{PLH}), before telling the V_{OS} Calibration circuitry (see Figure 4-2) to start. If the $\overline{\text{EN/CAL}}$ pin is toggled during this time, the fixed delay is restarted (takes an additional time t_{PLH}).

4.2.4 PARITY DETECTOR

A parity error detector monitors the memory contents for any corruption. In the rare event that a parity error is detected (e.g., corruption from an alpha particle), a POR event is automatically triggered. This will cause the input offset voltage to be re-corrected, and the op amp will not return to normal operation for a period of time (the POR turn on time, t_{PLH}).

4.2.5 RAIL-TO-RAIL OUTPUT

The Minimum Output Voltage (V_{OL}) and Maximum Output Voltage (V_{OH}) specs describe the widest output swing that can be achieved under the specified load conditions.

The output can also be limited when V_{IP} or V_{IM} exceeds V_{IVL} or V_{IVH} , or when V_{DM} exceeds V_{DML} or V_{DMH} .

4.3 Applications Tips

4.3.1 MINIMUM STABLE GAIN

There are different options for different Minimum Stable Gains (1, 2, 5, 10 and 100 V/V; see Table 1-1). The differential gain (G_{DM}) needs to be greater than or equal to G_{MIN} in order to maintain stability.

Picking a part with higher G_{MIN} has the advantages of lower Input Noise Voltage Density (e_{ni}), lower Input Offset Voltage (V_{OS}) and increased Gain Bandwidth Product (GBWP); see Table 1. The Differential Input Voltage Range (V_{DMR}) is lower for higher G_{MIN} , but the output voltage range would limit V_{DMR} anyway, when $G_{\text{DM}} \geq 2$.

4.3.2 CAPACITIVE LOADS

Driving large capacitive loads can cause stability problems for amplifiers. As the load capacitance increases, the feedback loop's phase margin decreases, and the closed-loop bandwidth is reduced. This produces gain peaking in the frequency response, with overshoot and ringing in the step response. Lower gains (G_{DM}) exhibit greater sensitivity to capacitive loads.

When driving large capacitive loads with these instrumentation amps (e.g., $> 100 \text{ pF}$), a small series resistor at the output (R_{ISO} in Figure 4-8) improves the feedback loop's phase margin (stability) by making the output load resistive at higher frequencies. The bandwidth will be generally lower than the bandwidth with no capacitive load.



FIGURE 4-8: Output Resistor, R_{ISO} stabilizes large capacitive loads.

Figure 4-9 gives recommended R_{ISO} values for different capacitive loads and gains. The x-axis is the normalized load capacitance ($C_L G_{\text{MIN}}/G_{\text{DM}}$), where G_{DM} is the circuit's differential gain ($1 + R_F / R_G$) and G_{MIN} is the minimum stable gain.

MCP6N11



FIGURE 4-9: Recommended R_{ISO} Values for Capacitive Loads.

After selecting R_{ISO} for your circuit, double check the resulting frequency response peaking and step response overshoot on the bench. Modify R_{ISO} 's value until the response is reasonable.

4.3.3 GAIN RESISTORS

Figure 4-10 shows a simple gain circuit with the INA's input capacitances at the feedback inputs (V_{REF} and V_{FG}). These capacitances interact with R_G and R_F to modify the gain at high frequencies. The equivalent capacitance acting in parallel to R_G is $C_G = C_{DM} + C_{CM}$ plus any board capacitance in parallel to R_G . C_G will cause an increase in G_{DM} at high frequencies, which reduces the phase margin of the feedback loop (i.e., reduce the feedback loop's stability).

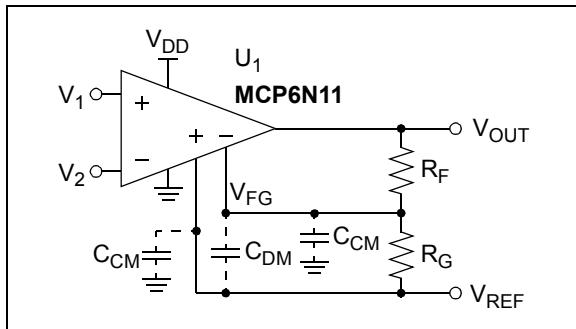

FIGURE 4-10: Simple Gain Circuit with Parasitic Capacitances.

In this data sheet, $R_F + R_G = 10 \text{ k}\Omega$ for most gains (0Ω for $G_{DM} = 1$); see Table 1-6. This choice gives good Phase Margin. In general, R_F (Figure 4-10) needs to meet the following limits to maintain stability:

EQUATION 4-12:

For $G_{DM} = 1$:

$$R_F = 0$$

For $G_{DM} > 1$:

$$R_F < \frac{\alpha G_{DM}^2}{2\pi f_{GBWP} C_G}$$

Where:

$$\alpha \leq 0.25$$

$$G_{DM} \geq G_{MIN}$$

$$f_{GBWP} = \text{Gain Bandwidth Product}$$

$$C_G = C_{DM} + C_{CM} + (\text{PCB stray capacitance})$$

4.3.4 SUPPLY BYPASS

With these INAs, the power supply pin (V_{DD} for single supply) should have a local bypass capacitor (i.e., $0.01 \mu\text{F}$ to $0.1 \mu\text{F}$) within 2 mm for good high frequency performance. Surface mount, multilayer ceramic capacitors, or their equivalent, should be used.

These INAs require a bulk capacitor (i.e., $1.0 \mu\text{F}$ or larger) within 100 mm, to provide large, slow currents. This bulk capacitor can be shared with other nearby analog parts as long as crosstalk through the supplies does not prove to be a problem.

4.4 Typical Applications

4.4.1 HIGH INPUT IMPEDANCE DIFFERENCE AMPLIFIER

Figure 4-11 shows the MCP6N11 used as a difference amplifier. The inputs are high impedance and give good CMRR performance.



FIGURE 4-11: Difference Amplifier.

4.4.2 DIFFERENCE AMPLIFIER FOR VERY LARGE COMMON MODE SIGNALS

Figure 4-12 shows the MCP6N11 INA used as a difference amplifier for signals with a very large common mode component. The input resistor dividers (R_1 and R_2) ensure that the voltages at the INA's inputs are within their range of normal operation. The capacitors C_1 , with the parasitic capacitances C_2 (the resistors' parasitic capacitance plus the INA's input common mode capacitance, C_{CM}), set the same division ratio, so that high-frequency signals (e.g., a step in voltage) have the same gain. Select the INA gain to compensate for R_1 and R_2 's attenuation. Select R_1 and R_2 's tolerances for good CMRR.



FIGURE 4-12: Difference Amplifier with Very Large Common Mode Component.

4.4.3 HIGH SIDE CURRENT DETECTOR

Figure 4-13 shows the MCP6N11 INA used as to detect and amplify the high side current in a battery powered design. The INA gain is set at 21 V/V, so V_{OUT} changes 210 mV for every 1 mA of I_{DD} current. The best G_{MIN} option to pick would be a gain of 10 (MCP6N11-010).



FIGURE 4-13: High Side Current Detector.

4.4.4 WHEATSTONE BRIDGE

Figure 4-14 shows the MCP6N11 single instrumentation amp used to condition the signal from a Wheatstone bridge (e.g., strain gage). The overall INA gain is set at 201 V/V. The best G_{MIN} option to pick, for this gain, is 100 V/V (MCP6N11-100).



FIGURE 4-14: Wheatstone Bridge Amplifier.

MCP6N11

NOTES:

5.0 DESIGN AIDS

Microchip provides the basic design aids needed for the MCP6N11 instrumentation amplifiers.

5.1 Microchip Advanced Part Selector (MAPS)

MAPS is a software tool that helps efficiently identify Microchip devices that fit a particular design requirement. Available at no cost from the Microchip website at www.microchip.com/maps, the MAPS is an overall selection tool for Microchip's product portfolio that includes Analog, Memory, MCUs and DSCs. Using this tool, a customer can define a filter to sort features for a parametric search of devices and export side-by-side technical comparison reports. Helpful links are also provided for Data sheets, Purchase and Sampling of Microchip parts.

5.2 Analog Demonstration Board

Microchip offers a broad spectrum of Analog Demonstration and Evaluation Boards that are designed to help customers achieve faster time to market. For a complete listing of these boards and their corresponding user's guides and technical information, visit the Microchip web site at [www.microchip.com/analog tools](http://www.microchip.com/analog_tools).

5.3 Application Notes

The following Microchip Application Notes are available on the Microchip web site at www.microchip.com/appnotes and are recommended as supplemental reference resources.

- **AN884:** *"Driving Capacitive Loads With Op Amps"*, DS00884
- **AN990:** *"Analog Sensor Conditioning Circuits – An Overview"*, DS00990
- **AN1228:** *"Op Amp Precision Design: Random Noise"*, DS01228

Some of these application notes, and others, are listed in the design guide:

- *"Signal Chain Design Guide"*, DS21825

MCP6N11

NOTES:

6.0 PACKAGING INFORMATION

6.1 Package Marking Information

8-Lead SOIC (150 mil) (MCP6N11)



Example



Note: The example is for a MCP6N11-001 part.

8-Lead TDFN (2x3) (MCP6N11)



Device	Code
MCP6N11-001	AAQ
MCP6N11-002	AAR
MCP6N11-005	AAS
MCP6N11-010	AAT
MCP6N11-100	AAU

Note: Applies to 8-Lead 2x3 TDFN

Example



Legend:	XX...X	Customer-specific information
	Y	Year code (last digit of calendar year)
	YY	Year code (last 2 digits of calendar year)
	WW	Week code (week of January 1 is week '01')
	NNN	Alphanumeric traceability code
	(e3)	Pb-free JEDEC designator for Matte Tin (Sn)
	*	This package is Pb-free. The Pb-free JEDEC designator (e3) can be found on the outer packaging for this package.
Note:	In the event the full Microchip part number cannot be marked on one line, it will be carried over to the next line, thus limiting the number of available characters for customer-specific information.	

MCP6N11

8-Lead Plastic Small Outline (SN) - Narrow, 3.90 mm Body [SOIC]

Note: For the most current package drawings, please see the Microchip Packaging Specification located at <http://www.microchip.com/packaging>



Microchip Technology Drawing No. C04-057C Sheet 1 of 2

8-Lead Plastic Small Outline (SN) - Narrow, 3.90 mm Body [SOIC]

Note: For the most current package drawings, please see the Microchip Packaging Specification located at <http://www.microchip.com/packaging>



Dimension Limits	Units	MILLIMETERS		
		MIN	NOM	MAX
Number of Pins	N	8		
Pitch	e	1.27 BSC		
Overall Height	A	-	-	1.75
Molded Package Thickness	A2	1.25	-	-
Standoff §	A1	0.10	-	0.25
Overall Width	E	6.00 BSC		
Molded Package Width	E1	3.90 BSC		
Overall Length	D	4.90 BSC		
Chamfer (Optional)	h	0.25	-	0.50
Foot Length	L	0.40	-	1.27
Footprint	L1	1.04 REF		
Foot Angle	φ	0°	-	8°
Lead Thickness	c	0.17	-	0.25
Lead Width	b	0.31	-	0.51
Mold Draft Angle Top	α	5°	-	15°
Mold Draft Angle Bottom	β	5°	-	15°

Notes:

1. Pin 1 visual index feature may vary, but must be located within the hatched area.
2. § Significant Characteristic
3. Dimensions D and E1 do not include mold flash or protrusions. Mold flash or protrusions shall not exceed 0.15mm per side.
4. Dimensioning and tolerancing per ASME Y14.5M

BSC: Basic Dimension. Theoretically exact value shown without tolerances.

REF: Reference Dimension, usually without tolerance, for information purposes only.

Microchip Technology Drawing No. C04-057C Sheet 2 of 2

MCP6N11

8-Lead Plastic Small Outline (SN) – Narrow, 3.90 mm Body [SOIC]

Note: For the most current package drawings, please see the Microchip Packaging Specification located at <http://www.microchip.com/packaging>



RECOMMENDED LAND PATTERN

		Units	MILLIMETERS		
		Dimension Limits	MIN	NOM	MAX
Contact Pitch	E	1.27 BSC			
Contact Pad Spacing	C		5.40		
Contact Pad Width (X8)	X1				0.60
Contact Pad Length (X8)	Y1				1.55

Notes:

1. Dimensioning and tolerancing per ASME Y14.5M

BSC: Basic Dimension. Theoretically exact value shown without tolerances.

Microchip Technology Drawing No. C04-2057A

8-Lead Plastic Dual Flat, No Lead Package (MN) – 2x3x0.75mm Body [TDFN]

Note: For the most current package drawings, please see the Microchip Packaging Specification located at <http://www.microchip.com/packaging>



Microchip Technology Drawing No. C04-129C Sheet 1 of 2

MCP6N11

8-Lead Plastic Dual Flat, No Lead Package (MN) – 2x3x0.75mm Body [TDFN]

Note: For the most current package drawings, please see the Microchip Packaging Specification located at <http://www.microchip.com/packaging>



Dimension Limits	Units	MILLIMETERS		
		MIN	NOM	MAX
Number of Pins	N	8		
Pitch	e	0.50 BSC		
Overall Height	A	0.70	0.75	0.80
Standoff	A1	0.00	0.02	0.05
Contact Thickness	A3	0.20 REF		
Overall Length	D	2.00 BSC		
Overall Width	E	3.00 BSC		
Exposed Pad Length	D2	1.20	-	1.60
Exposed Pad Width	E2	1.20	-	1.60
Contact Width	b	0.20	0.25	0.30
Contact Length	L	0.25	0.30	0.45
Contact-to-Exposed Pad	K	0.20	-	-

Notes:

1. Pin 1 visual index feature may vary, but must be located within the hatched area.
2. Package may have one or more exposed tie bars at ends.
3. Package is saw singulated
4. Dimensioning and tolerancing per ASME Y14.5M

BSC: Basic Dimension. Theoretically exact value shown without tolerances.

REF: Reference Dimension, usually without tolerance, for information purposes only.

Microchip Technology Drawing No. C04-129C Sheet 2 of 2

8-Lead Plastic Dual Flat, No Lead Package (MN) – 2x3x0.75 mm Body [TDFN]

Note: For the most current package drawings, please see the Microchip Packaging Specification located at <http://www.microchip.com/packaging>



RECOMMENDED LAND PATTERN

Dimension Limits	Units	MILLIMETERS		
		MIN	NOM	MAX
Contact Pitch	E	0.50 BSC		
Optional Center Pad Width	W2			1.46
Optional Center Pad Length	T2			1.36
Contact Pad Spacing	C1		3.00	
Contact Pad Width (X8)	X1			0.30
Contact Pad Length (X8)	Y1			0.75
Distance Between Pads	G	0.20		

Notes:

1. Dimensioning and tolerancing per ASME Y14.5M

BSC: Basic Dimension. Theoretically exact value shown without tolerances.

Microchip Technology Drawing No. C04-2129A

MCP6N11

NOTES:

APPENDIX A: REVISION HISTORY

Revision A (October 2011)

- Original Release of this Document.

MCP6N11

NOTES:

PRODUCT IDENTIFICATION SYSTEM

To order or obtain information, e.g., on pricing or delivery, refer to the factory or the listed sales office.

<u>PART NO.</u>	<u>-X</u>	<u>X</u>	<u>/XX</u>
Device	Gain Option	Temperature Range	Package
Device:	MCP6N11	Single Instrumentation Amplifier	
	MCP6N11T	Single Instrumentation Amplifier (Tape and Reel)	
Gain Option:	001 = Minimum gain of 1 V/V		
	002 = Minimum gain of 2 V/V		
	005 = Minimum gain of 5 V/V		
	010 = Minimum gain of 10 V/V		
	100 = Minimum gain of 100 V/V		
Temperature Range:	E	= -40°C to +125°C	
Package:	MNY	= 2×3 TDFN, 8-lead *	
	SN	= Plastic SOIC (150mil Body), 8-lead	
	* Y = nickel palladium gold manufacturing designator. Only available on the TDFN package.		

Examples:

a) MCP6N11T-001E/MNY: Tape and Reel, Minimum gain = 1, Extended temperature, 8LD 2×3 TDFN.

b) MCP6N11-002E/SN: Minimum gain = 2, Extended temperature, 8LD SOIC.

MCP6N11

NOTES:

Note the following details of the code protection feature on Microchip devices:

- Microchip products meet the specification contained in their particular Microchip Data Sheet.
- Microchip believes that its family of products is one of the most secure families of its kind on the market today, when used in the intended manner and under normal conditions.
- There are dishonest and possibly illegal methods used to breach the code protection feature. All of these methods, to our knowledge, require using the Microchip products in a manner outside the operating specifications contained in Microchip's Data Sheets. Most likely, the person doing so is engaged in theft of intellectual property.
- Microchip is willing to work with the customer who is concerned about the integrity of their code.
- Neither Microchip nor any other semiconductor manufacturer can guarantee the security of their code. Code protection does not mean that we are guaranteeing the product as “unbreakable.”

Code protection is constantly evolving. We at Microchip are committed to continuously improving the code protection features of our products. Attempts to break Microchip's code protection feature may be a violation of the Digital Millennium Copyright Act. If such acts allow unauthorized access to your software or other copyrighted work, you may have a right to sue for relief under that Act.

Information contained in this publication regarding device applications and the like is provided only for your convenience and may be superseded by updates. It is your responsibility to ensure that your application meets with your specifications. MICROCHIP MAKES NO REPRESENTATIONS OR WARRANTIES OF ANY KIND WHETHER EXPRESS OR IMPLIED, WRITTEN OR ORAL, STATUTORY OR OTHERWISE, RELATED TO THE INFORMATION, INCLUDING BUT NOT LIMITED TO ITS CONDITION, QUALITY, PERFORMANCE, MERCHANTABILITY OR FITNESS FOR PURPOSE. Microchip disclaims all liability arising from this information and its use. Use of Microchip devices in life support and/or safety applications is entirely at the buyer's risk, and the buyer agrees to defend, indemnify and hold harmless Microchip from any and all damages, claims, suits, or expenses resulting from such use. No licenses are conveyed, implicitly or otherwise, under any Microchip intellectual property rights.

Trademarks

The Microchip name and logo, the Microchip logo, dsPIC, KEELOQ, KEELOQ logo, MPLAB, PIC, PICmicro, PICSTART, PIC³² logo, rPIC and UNI/O are registered trademarks of Microchip Technology Incorporated in the U.S.A. and other countries.

FilterLab, Hampshire, HI-TECH C, Linear Active Thermistor, MXDEV, MXLAB, SEEVAL and The Embedded Control Solutions Company are registered trademarks of Microchip Technology Incorporated in the U.S.A.

Analog-for-the-Digital Age, Application Maestro, chipKIT, chipKIT logo, CodeGuard, dsPICDEM, dsPICDEM.net, dsPICworks, dsSPEAK, ECAN, ECONOMONITOR, FanSense, HI-TIDE, In-Circuit Serial Programming, ICSP, Mindi, MiWi, MPASM, MPLAB Certified logo, MPLIB, MPLINK, mTouch, Omniscient Code Generation, PICC, PICC-18, PICDEM, PICDEM.net, PICKit, PICtail, REAL ICE, rLAB, Select Mode, Total Endurance, TSHARC, UniWinDriver, WiperLock and ZENA are trademarks of Microchip Technology Incorporated in the U.S.A. and other countries.

SQTP is a service mark of Microchip Technology Incorporated in the U.S.A.

All other trademarks mentioned herein are property of their respective companies.

© 2011, Microchip Technology Incorporated, Printed in the U.S.A., All Rights Reserved.

 Printed on recycled paper.

ISBN: 978-1-61341-685-3

Microchip received ISO/TS-16949:2009 certification for its worldwide headquarters, design and wafer fabrication facilities in Chandler and Tempe, Arizona; Gresham, Oregon and design centers in California and India. The Company's quality system processes and procedures are for its PIC[®] MCUs and dsPIC[®] DSCs, KEELOQ[®] code hopping devices, Serial EEPROMs, microperipherals, nonvolatile memory and analog products. In addition, Microchip's quality system for the design and manufacture of development systems is ISO 9001:2000 certified.

QUALITY MANAGEMENT SYSTEM
CERTIFIED BY DNV
== ISO/TS 16949:2009 ==



MICROCHIP

Worldwide Sales and Service

AMERICAS

Corporate Office
2355 West Chandler Blvd.
Chandler, AZ 85224-6199
Tel: 480-792-7200
Fax: 480-792-7277
Technical Support:
<http://www.microchip.com/support>
Web Address:
www.microchip.com

Atlanta
Duluth, GA
Tel: 678-957-9614
Fax: 678-957-1455

Boston
Westborough, MA
Tel: 774-760-0087
Fax: 774-760-0088

Chicago
Itasca, IL
Tel: 630-285-0071
Fax: 630-285-0075

Cleveland
Independence, OH
Tel: 216-447-0464
Fax: 216-447-0643

Dallas
Addison, TX
Tel: 972-818-7423
Fax: 972-818-2924

Detroit
Farmington Hills, MI
Tel: 248-538-2250
Fax: 248-538-2260

Indianapolis
Noblesville, IN
Tel: 317-773-8323
Fax: 317-773-5453

Los Angeles
Mission Viejo, CA
Tel: 949-462-9523
Fax: 949-462-9608

Santa Clara
Santa Clara, CA
Tel: 408-961-6444
Fax: 408-961-6445

Toronto
Mississauga, Ontario,
Canada
Tel: 905-673-0699
Fax: 905-673-6509

ASIA/PACIFIC

Asia Pacific Office
Suites 3707-14, 37th Floor
Tower 6, The Gateway
Harbour City, Kowloon
Hong Kong
Tel: 852-2401-1200
Fax: 852-2401-3431

Australia - Sydney
Tel: 61-2-9868-6733
Fax: 61-2-9868-6755

China - Beijing
Tel: 86-10-8569-7000
Fax: 86-10-8528-2104

China - Chengdu
Tel: 86-28-8665-5511
Fax: 86-28-8665-7889

China - Chongqing
Tel: 86-23-8980-9588
Fax: 86-23-8980-9500

China - Hangzhou
Tel: 86-571-2819-3187
Fax: 86-571-2819-3189

China - Hong Kong SAR
Tel: 852-2401-1200
Fax: 852-2401-3431

China - Nanjing
Tel: 86-25-8473-2460
Fax: 86-25-8473-2470

China - Qingdao
Tel: 86-532-8502-7355
Fax: 86-532-8502-7205

China - Shanghai
Tel: 86-21-5407-5533
Fax: 86-21-5407-5066

China - Shenyang
Tel: 86-24-2334-2829
Fax: 86-24-2334-2393

China - Shenzhen
Tel: 86-755-8203-2660
Fax: 86-755-8203-1760

China - Wuhan
Tel: 86-27-5980-5300
Fax: 86-27-5980-5118

China - Xian
Tel: 86-29-8833-7252
Fax: 86-29-8833-7256

China - Xiamen
Tel: 86-592-2388138
Fax: 86-592-2388130

China - Zhuhai
Tel: 86-756-3210040
Fax: 86-756-3210049

ASIA/PACIFIC

India - Bangalore
Tel: 91-80-3090-4444
Fax: 91-80-3090-4123

India - New Delhi
Tel: 91-11-4160-8631
Fax: 91-11-4160-8632

India - Pune
Tel: 91-20-2566-1512
Fax: 91-20-2566-1513

Japan - Yokohama
Tel: 81-45-471- 6166
Fax: 81-45-471-6122

Korea - Daegu
Tel: 82-53-744-4301
Fax: 82-53-744-4302

Korea - Seoul
Tel: 82-2-554-7200
Fax: 82-2-558-5932 or
82-2-558-5934

Malaysia - Kuala Lumpur
Tel: 60-3-6201-9857
Fax: 60-3-6201-9859

Malaysia - Penang
Tel: 60-4-227-8870
Fax: 60-4-227-4068

Philippines - Manila
Tel: 63-2-634-9065
Fax: 63-2-634-9069

Singapore
Tel: 65-6334-8870
Fax: 65-6334-8850

Taiwan - Hsin Chu
Tel: 886-3-5778-366
Fax: 886-3-5770-955

Taiwan - Kaohsiung
Tel: 886-7-536-4818
Fax: 886-7-330-9305

Taiwan - Taipei
Tel: 886-2-2500-6610
Fax: 886-2-2508-0102

Thailand - Bangkok
Tel: 66-2-694-1351
Fax: 66-2-694-1350

EUROPE

Austria - Wels
Tel: 43-7242-2244-39
Fax: 43-7242-2244-393

Denmark - Copenhagen
Tel: 45-4450-2828
Fax: 45-4485-2829

France - Paris
Tel: 33-1-69-53-63-20
Fax: 33-1-69-30-90-79

Germany - Munich
Tel: 49-89-627-144-0
Fax: 49-89-627-144-44

Italy - Milan
Tel: 39-0331-742611
Fax: 39-0331-466781

Netherlands - Drunen
Tel: 31-416-690399
Fax: 31-416-690340

Spain - Madrid
Tel: 34-91-708-08-90
Fax: 34-91-708-08-91

UK - Wokingham
Tel: 44-118-921-5869
Fax: 44-118-921-5820

08/02/11