

PKFM3020C-D2 thru PKFM30200C-D2

SCHOTTKY BARRIER RECTIFIER

30.0A Surface Mount Schottky Barrier Rectifiers - 20V-200V

D2PAK

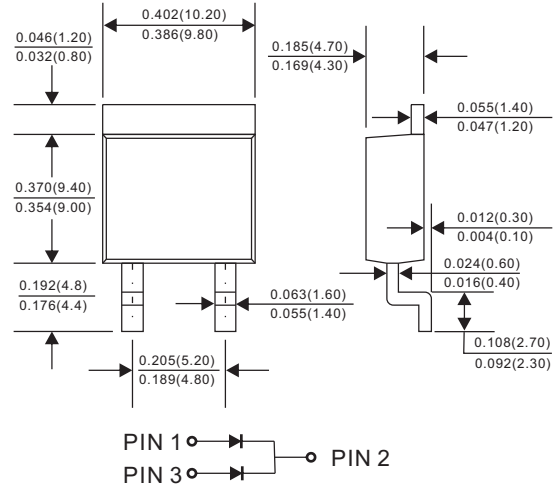
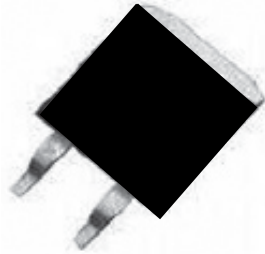

Dimensions in inches and (millimeters)

FEATURES

- Batch process design, excellent power dissipation offers better reverse leakage current and thermal resistance.
- Low profile surface mounted application in order to optimize board space.
- Low power loss, high efficiency.
- High current capability, low forward voltage drop.
- High surge capability.
- Guardring for overvoltage protection.
- Ultra high-speed switching.
- Silicon epitaxial planar chip, metal silicon junction.
- Lead-free parts meet environmental standards of MIL-STD-19500 /228
- Suffix "-H" indicates Halogen-free parts, ex. PKFM3020C-D2-H.

MECHANICAL DATA

- Epoxy: UL94-V0 rated flame retardant
- Case : Molded plastic, TO-263 / D2PAK
- Terminals : Solder plated, solderable per MIL-STD-750, Method 2026
- Mounting Position : Any
- Weight : Approximated 1.46 gram

MAXIMUM RATINGS AND ELECTRICAL CHARACTERISTICS AT $T_A=25^{\circ}\text{C}$ unless otherwise noted)

PARAMETER	CONDITIONS	Symbol	MIN.	TYP.	MAX.	UNIT
Forward rectified current	See Fig.1	I_o			30.0	A
Forward surge current	8.3ms single half sine-wave superimposed on rate load (JEDEC methode)	I_{FSM}			150	A
Reverse current	$V_R = V_{RRM} \quad T_J = 25^{\circ}\text{C}$	I_R			0.5	mA
	$V_R = V_{RRM} \quad T_J = 100^{\circ}\text{C}$				50	
Storage temperature		T_{STG}	-65		+175	$^{\circ}\text{C}$

SYMBOLS	V_{RRM}^{*1} (V)	V_{RMS}^{*2} (V)	V_R^{*3} (V)	V_F^{*4} (V)	Operating temperature $T_J, (^{\circ}\text{C})$
PKFM3020C-D2	20	14	20	0.55	-55 to +125
PKFM3030C-D2	30	21	30		
PKFM3040C-D2	40	28	40		
PKFM3045C-D2	45	31.5	45	0.70	-55 to +150
PKFM3050C-D2	50	35	50		
PKFM3060C-D2	60	42	60	0.85	-55 to +150
PKFM3080C-D2	80	56	80		
PKFM30100C-D2	100	70	100		
PKFM30150C-D2	150	105	150	0.90	
PKFM30200C-D2	200	140	200	0.92	

*1 Repetitive peak reverse voltage

*2 RMS voltage

*3 Continuous reverse voltage

*4 Maximum forward voltage@ $I_f = 15.0\text{A}$

PKFM3020C-D2 thru PKFM30200C-D2

SCHOTTKY BARRIER RECTIFIER

Rating and characteristic curves (PKFM3020C-D2 THRU PKFM30200C-D2)

FIG.1-TYPICAL FORWARD CURRENT DERATING CURVE

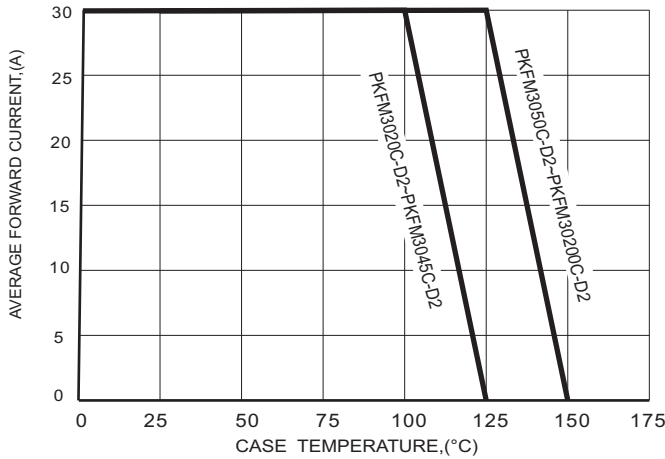

FIG.2-TYPICAL FORWARD CHARACTERISTICS

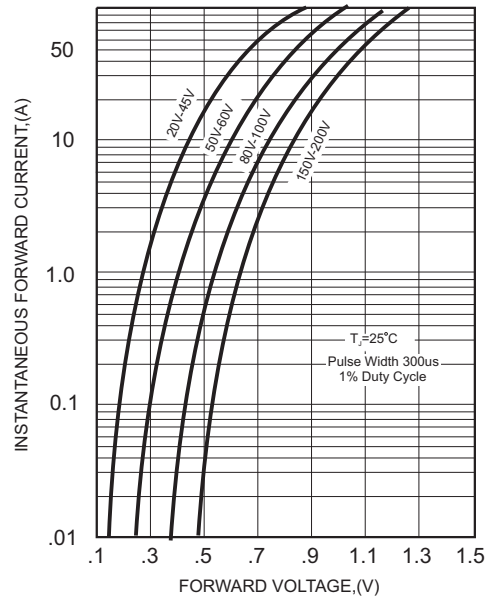

FIG.3-MAXIMUM NON-REPETITIVE FORWARD SURGE CURRENT

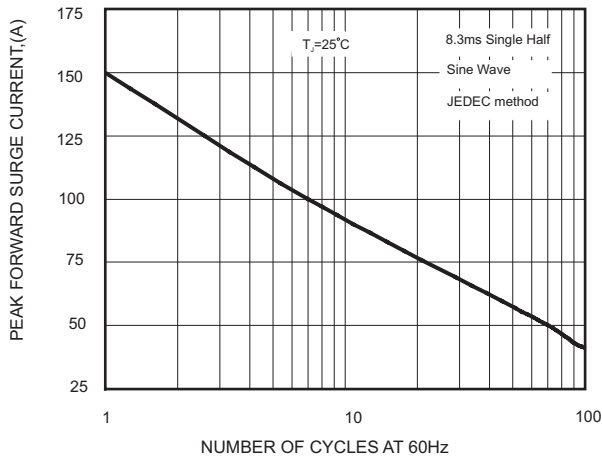
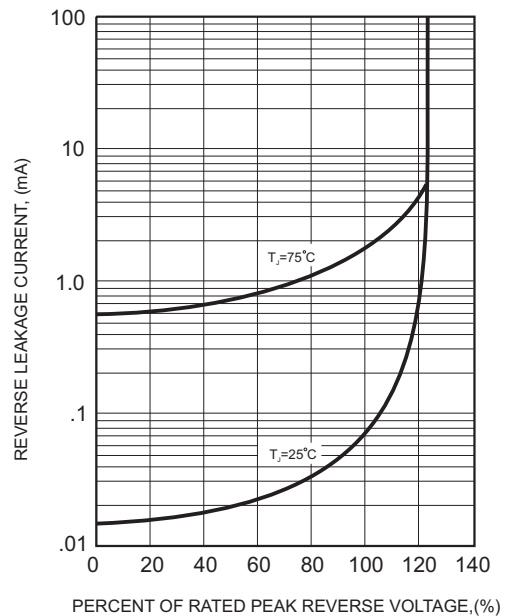

FIG.4 - TYPICAL REVERSE CHARACTERISTICS



PKFM3020C-D2 thru PKFM30200C-D2

SCHOTTKY BARRIER RECTIFIER

Pinning information

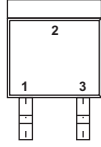
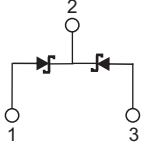
Simplified outline	Symbol
	

Marking

Type number	Marking code
PKFM3020C-D2	SK3020
PKFM3030C-D2	SK3030
PKFM3040C-D2	SK3040
PKFM3045C-D2	SK3040
PKFM3050C-D2	SK3050
PKFM3060C-D2	SK3060
PKFM3080C-D2	SK3080
PKFM30100C-D2	SK30100
PKFM30150C-D2	SK30150
PKFM30200C-D2	SK30200

Suggested solder pad layout

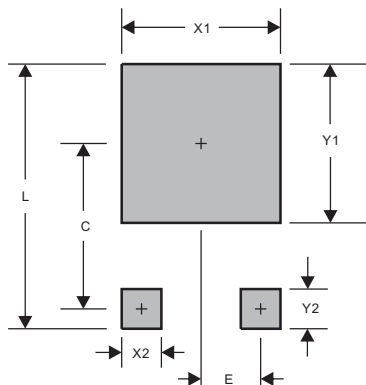

PACKAGE	D2PAK
C	0.374(9.50)
E	0.098(2.50)
L	0.665(16.90)
X1	0.425(10.80)
X2	0.071(1.80)
Y1	0.449(11.40)
Y2	0.138(3.50)

Dimensions in inches and (millimeters)