

General Specifications

Toggles

Rockers

Pushbuttons

Illuminated PB

Programmable

Keylocks

Rotaries

Slides

Tactiles

Tilt

Touch

Indicators

Accessories

Supplement

B Electrical Capacity (Resistive Load)

Logic Level: 0.4VA maximum @ 28V AC/DC maximum
(Applicable Range 0.1mA ~ 0.1A @ 20mV ~ 28V)
Note: Find additional explanation of operating range in Supplement section.

Other Ratings

Contact Resistance: 80 milliohms maximum
Insulation Resistance: 500 megohms minimum @ 500V DC
Dielectric Strength: 500V AC minimum for 1 minute minimum
Mechanical Life: 50,000 operations minimum
Electrical Life: 50,000 operations minimum
Nominal Operating Force: 1.0N
Angle of Throw: 28°

Materials & Finishes

Actuator: Polycarbonate resin (UL94V-0)
Case: Glass fiber reinforced polyamide (UL94V-0)
Sealing Ring: Nitrile butadiene rubber
Base: Glass fiber reinforced polyamide
Movable Contact: Phosphor bronze with gold plating
Stationary Contact: Phosphor bronze with gold plating
Terminals: Phosphor bronze with gold plating

Environmental Data

Operating Temperature Range: -25°C through +55°C (-13°F through +131°F)
Humidity: 90 ~ 95% humidity for 240 hours @ 40°C (104°F)
Vibration: 10 ~ 55Hz with peak-to-peak amplitude of 1.5mm traversing the frequency range & returning in 5 minutes; 3 right angled directions for 2 hours
Shock: 50G (490m/s²) acceleration (tested in 3 right angled directions, with 5 shocks in each direction)

PCB Processing

Soldering: Wave Soldering recommended. See Profile A in Supplement section.
Manual Soldering: See Profile A in Supplement section.
Cleaning: These devices are not process sealed. Hand clean locally using alcohol based solution.

Standards & Certifications

Flammability Standard: UL94V-0 actuator & case

The GW Series illuminated paddles have not been tested for UL recognition or CSA certification. These switches are designed for use in a low-voltage, low-current, logic-level circuit. When used as intended in a logic-level circuit, the results do not produce hazardous energy.

Distinctive Characteristics

World's smallest fully illuminated paddles (patent pending) for highly visible status indication; LEDs available in red, green, or amber for single color and red/green for bicolor.

Specially designed switching mechanism provides crisp actuation feedback to positively indicate circuit transfer (patent pending).

Insert molded terminals prevent entry of flux and other contaminants.

Award-winning STC contact mechanism with benefits unavailable in conventional mechanisms: smoother, positive detent actuation, increased contact stability, and unparalleled logic-level reliability. (Additional STC details in Terms & Acronyms; see Supplement section.)

.100" x .100" (2.54mm x 2.54mm) terminal spacing conforms to standard PC board grid spacing for straight and angle mounting.

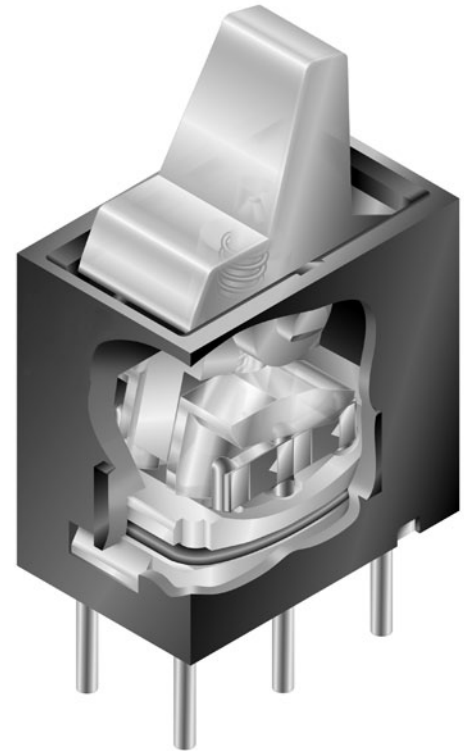

Actual Size

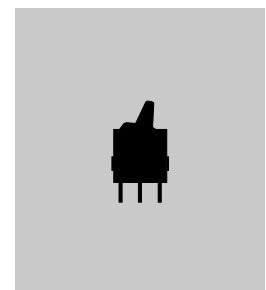

- Toggles
- B** Rockers
- Pushbuttons
- Illuminated PB
- Programmable
- Keylocks
- Rotaries
- Slides
- Tactiles
- Tilt
- Touch
- Indicators
- Accessories
- Supplement

TYPICAL SWITCH ORDERING EXAMPLE

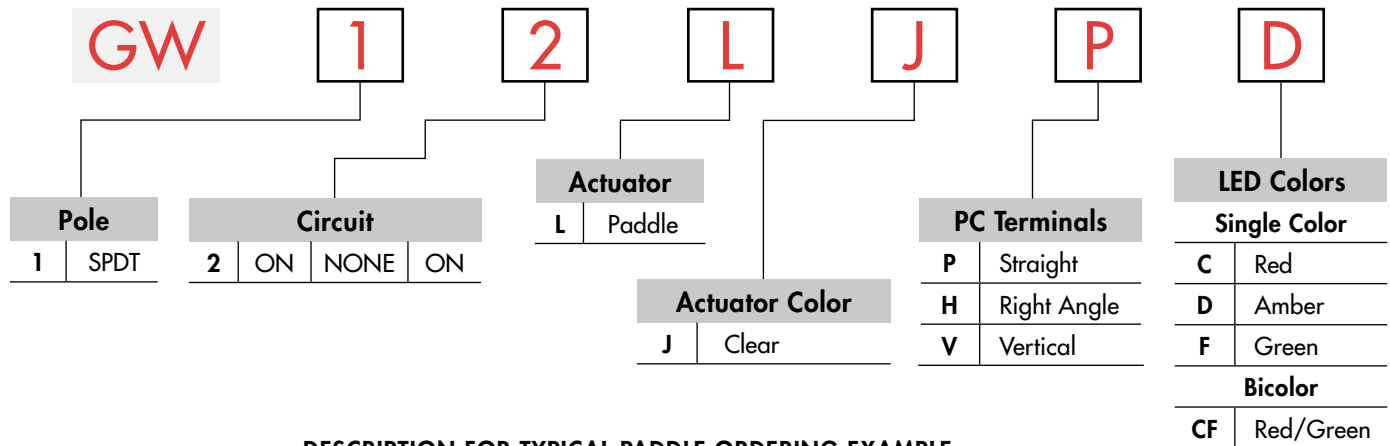

DESCRIPTION FOR TYPICAL PADDLE ORDERING EXAMPLE

GW12LJPD

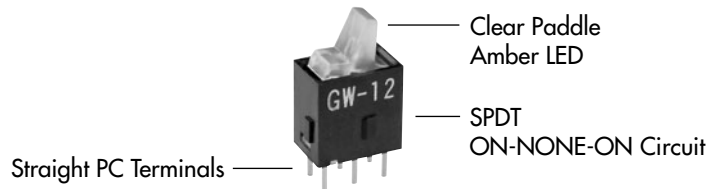

POLE & CIRCUIT

Pole	Model	Paddle Position			Connected Terminals			Throw & Schematics
		Up	Center	Down	Up	Center	Down	
SP	GW12	ON	NONE	ON	2-3	OPEN	2-1	Note: Terminal numbers are not actually on the switch. LED circuit is isolated and requires an external power source.

LED COLORS & SPECIFICATIONS

LEDs are an integral part of the the switch and not available separately. The electrical specifications shown are determined at a basic temperature of 25°C. If the source voltage exceeds the rated voltage, a ballast resistor is required. The resistor value can be calculated by using the formula in the Supplement section.

	Colors	Single Color			Bicolor
		C Red	D Amber	F Green	CF Red/Green
Forward Peak Current	I_{FM}	25mA	25mA	25mA	25mA/25mA
Typical Forward Current	I_F	20mA	20mA	20mA	20mA/20mA
Forward Voltage	V_F	2.0V	2.1V	2.1V	2.0V/2.1V
Reverse Peak Voltage	V_{RM}	4V	4V	4V	4V/4V
Current Reduction Rate Above 25°C	ΔI_F	0.33mA/°C	0.33mA/°C	0.33mA/°C	0.33mA/°C
Ambient Temperature Range		-25°C ~ +55°C			

TYPICAL SWITCH DIMENSIONS

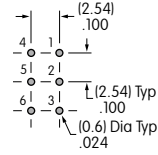
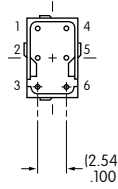
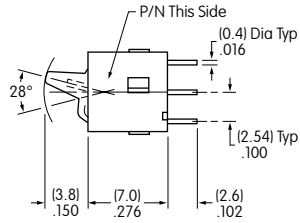
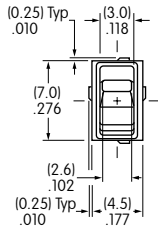

Straight PC



5 & 6 are LED terminals; 4 is a support pin on single color models & an LED terminal on bicolor models.

GW12LJPC

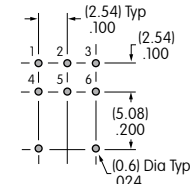
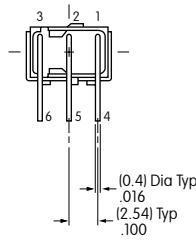
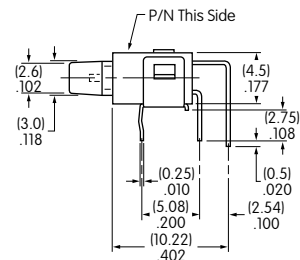
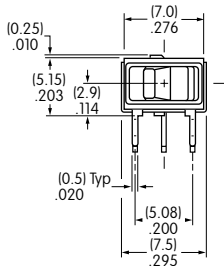
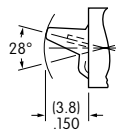

Right Angle PC



5 & 6 are LED terminals; 4 is a support pin on single color models & an LED terminal on bicolor models.

GW12LJHD

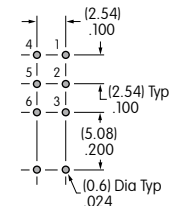
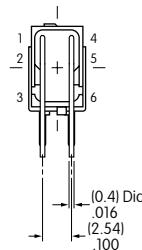
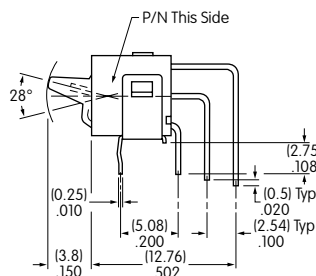
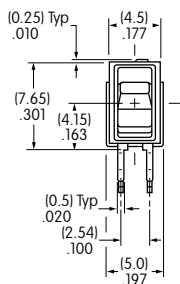

Vertical PC



5 & 6 are LED terminals; 4 is a support pin on single color models & an LED terminal on bicolor models.

GW12LJVC