

## Ultra Low Quiescent Current Linear Regulator

**UM153xxS SOT23-3**

**UM153xxY SOT89-3**

**UM154xxS SOT23-5**

### General Description

The UM153xx/UM154xx series are ultra low quiescent current low dropout linear regulators designed for low power portable applications. The range of output voltage is from 1.3V to 5.0V while operated from 2.2V to 5.5V input. The EN function of UM154xx can disable the entire circuit to be in shutdown state by inputting low level signal.

The UM153xx/UM154xx series offer high output voltage accuracy, excellent transient response, stability with ultra low ESR ceramic capacitors as small as 1 $\mu$ F, thermal overload protection and output current limiting. The UM153xx is available in a low profile SOT23-3 or SOT89-3 package. The UM154xx is available in a low profile SOT23-5 package.

### Applications

- Battery-Powered Systems
- Reference voltage sources
- Cameras, Video cameras
- Portable AV systems
- Portable games
- Cellular Phones

### Features

- Maximum Input Voltage: 5.5V
- $\pm 2.0\%$  Voltage Accuracy at 30mA
- Fast Transient Response
- Output Current Limit
- Stable with 1 $\mu$ F Output Capacitor
- Thermal Overload Protection
- Low Profile SOT23-3 or SOT89-3 Package(UM153xx)
- Low Profile SOT23-5 Package(UM154xx)

### UM153xx Series Pin Configurations & Top View

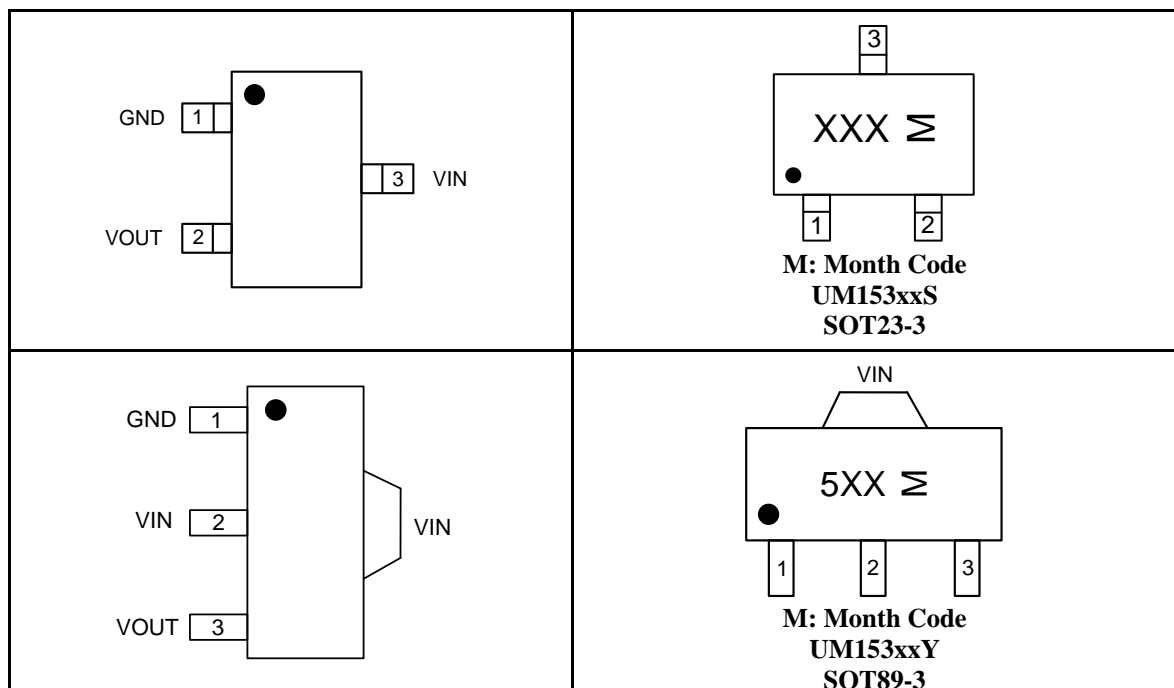

## UM154xx Series Pin Configurations & Top View

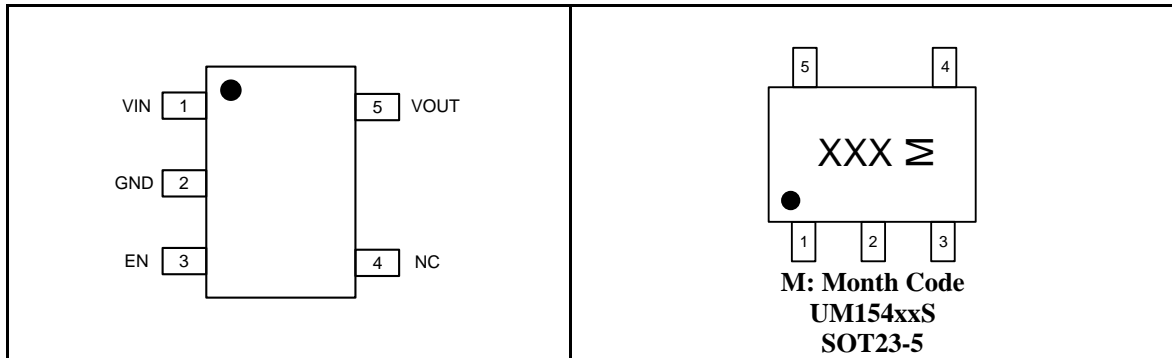

### Pin Description

Pin Number			Symbol	Function
UM153xxS	UM153xxY	UM154xxS		
3	2	1	VIN	Power Supply
1	1	2	GND	Ground
-	-	3	EN	Enable Input, Active High
-	-	4	NC	Not Connected
2	3	5	VOUT	Voltage Regulated Output

### Available Voltage Version

Part Number	Output Voltage	Marking Code	Package	Shipping Qty
UM15413S	1.3V	5FB	SOT23-5	3000pcs/7Inch Tape & Reel
UM15415S	1.5V	5FC	SOT23-5	
UM15418S	1.8V	5FD	SOT23-5	
UM15425S	2.5V	5FE	SOT23-5	
UM15427S	2.7V	5FF	SOT23-5	
UM15428S	2.8V	5FH	SOT23-5	
UM15430S	3.0V	5FL	SOT23-5	
UM15433S	3.3V	5FM	SOT23-5	
UM15435S	3.5V	5FJ	SOT23-5	
UM15436S	3.6V	5FK	SOT23-5	
UM15438S	3.8V	5FN	SOT23-5	
UM15440S	4.0V	5FP	SOT23-5	
UM15442S	4.2V	5FQ	SOT23-5	
UM15443S	4.3V	5FR	SOT23-5	
UM15445S	4.5V	5FS	SOT23-5	
UM15447S	4.7V	5FT	SOT23-5	
UM15448S	4.8V	5FY	SOT23-5	
UM15450S	5.0V	5FU	SOT23-5	

**Available Voltage Version (Continued)**

Part Number	Output Voltage	Marking Code	Package	Shipping Qty
UM15313S	1.3V	UC3	SOT23-3	3000pcs/7Inch Tape & Reel
UM15315S	1.5V	UC5	SOT23-3	
UM15318S	1.8V	UC8	SOT23-3	
UM15325S	2.5V	UD5	SOT23-3	
UM15327S	2.7V	UD7	SOT23-3	
UM15328S	2.8V	UD8	SOT23-3	
UM15330S	3.0V	UDA	SOT23-3	
UM15333S	3.3V	UG3	SOT23-3	
UM15335S	3.5V	UG5	SOT23-3	
UM15336S	3.6V	UG6	SOT23-3	
UM15338S	3.8V	UG8	SOT23-3	
UM15340S	4.0V	UGA	SOT23-3	
UM15342S	4.2V	UI2	SOT23-3	
UM15343S	4.3V	UI3	SOT23-3	
UM15345S	4.5V	UI5	SOT23-3	
UM15347S	4.7V	UI7	SOT23-3	
UM15348S	4.8V	UI8	SOT23-3	
UM15350S	5.0V	UIA	SOT23-3	
UM15313Y	1.3V	5A3	SOT89-3	1000pcs/7Inch Tape & Reel
UM15315Y	1.5V	5C5	SOT89-3	
UM15318Y	1.8V	5C8	SOT89-3	
UM15325Y	2.5V	5D5	SOT89-3	
UM15327Y	2.7V	5D7	SOT89-3	
UM15328Y	2.8V	5D8	SOT89-3	
UM15330Y	3.0V	5AA	SOT89-3	
UM15333Y	3.3V	5G3	SOT89-3	
UM15335Y	3.5V	5G5	SOT89-3	
UM15336Y	3.6V	5G6	SOT89-3	
UM15338Y	3.8V	5G8	SOT89-3	
UM15340Y	4.0V	5GA	SOT89-3	
UM15342Y	4.2V	5GC	SOT89-3	
UM15343Y	4.3V	5GD	SOT89-3	
UM15345Y	4.5V	5GH	SOT89-3	
UM15347Y	4.7V	5GM	SOT89-3	
UM15348Y	4.8V	5GJ	SOT89-3	
UM15350Y	5.0V	5GN	SOT89-3	

## Absolute Maximum Ratings (Note 1)

Symbol	Parameter	Value	Unit
$V_{IN}$	Supply Voltage on IN Pin	-0.3 to +6.5	V
$V_{OUT}$	Voltage on OUT Pin	-0.3 to +6.5	V
$V_{EN}$	Voltage on EN Pin	-0.3 to +6.5	V
$T_J$	Operating Junction Temperature (Notes 2, 3)	-40 to +125	°C
$T_{STG}$	Storage Temperature Range	-65 to +150	°C
$T_L$	Lead Temperature for Soldering 10 seconds	+300	°C

## Recommended Operating Conditions (Note 4)

Supply Input Voltage	2.2 V to 5.5V
Junction Temperature Range	-40 °C to 125 °C
Ambient Temperature Range	-40 °C to 85 °C

Note 1: Absolute Maximum Ratings are those values beyond which the life of a device may be impaired.

Note 2: The device is guaranteed to meet performance specifications from -40 °C to +85 °C. Specifications over the -40 °C to 125 °C operating junction temperature range are guaranteed by design, characterization and correlation with statistical process controls.

Note 3: This IC includes over temperature protection circuit inside that is intended to protect the device during momentary overload conditions. Over temperature protection trip point is around 160 °C. Continuous operation above the specified maximum operating junction temperature may impair device reliability.

Note 4: The device is not guaranteed to function outside its operating conditions.

## Internal Block Diagram

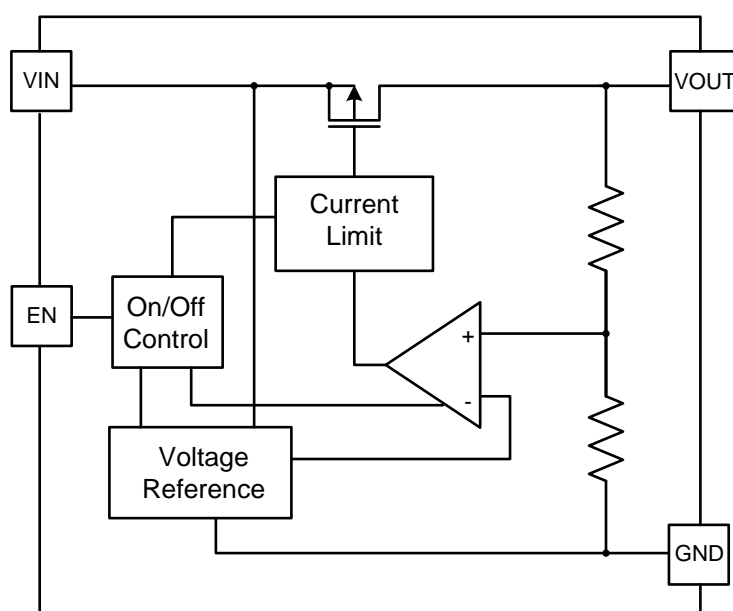

**Electrical Characteristics**

$V_{IN}=+5V \pm 10\%$ ,  $C_{IN}=1\mu F$ ,  $C_{OUT}=1\mu F$ ,  $T_A=-40\text{ }^\circ\text{C}$  to  $+85\text{ }^\circ\text{C}$ . Typical conditions are at  $V_{IN}=5V$ ,  $T_A=25\text{ }^\circ\text{C}$ .

Symbol	Parameter	Test Conditions	Min	Typ	Max	Unit
$V_{IN}$	Input Voltage Range		2.2		5.5	V
$V_{OUT}$	Output Voltage Range		1.3		5.0	V
$I_Q$	Quiescent Current	$I_{OUT}=0mA, V_{IN}=5.0V$		1.2	3	$\mu A$
$I_{SHDN}$	Standby Current	$V_{EN}=0V$			1	$\mu A$
$I_{ENH}$	Enable High Current	$V_{EN}=5.5V$			1	$\mu A$
$I_{ENL}$	Enable Low Current	$V_{EN}=0V$			1	$\mu A$
$I_{OUT}$	Output Current	$V_{IN} \geq 3V$	100			$mA$
		$V_{IN} \geq 3.5V$	200			$mA$
	Output Voltage Accuracy	$V_{IN}=V_{OUT}+1V (V_{IN} \geq 3V)$ , $1mA \leq I_{OUT} \leq 30mA$	-2.0		+2.0	%
$\Delta V_{DO}$	Dropout Voltage	$V_{OUT} \leq 2.0V, I_{OUT}=30mA$			$2.35 - V_{OUT}$	V
		$2.0V < V_{OUT} < 2.5V$ , $I_{OUT}=30mA$			0.25	
		$V_{OUT} \geq 2.5V, I_{OUT}=30mA$			0.13	
$I_{LIMIT}$	Current Limit			300		$mA$
	Output Voltage TC			150		ppm/ $^\circ\text{C}$
$T_{SHDN}$	Thermal-Shutdown Temperature			160		$^\circ\text{C}$
$\Delta T_{SHDN}$	Thermal-Shutdown Hysteresis			20		$^\circ\text{C}$
	Line Regulation	$V_{OUT}+1V \leq V_{IN} \leq 5.5V$ ( $V_{IN} \geq 3V$ ), $I_{OUT}=30mA$		$\pm 0.3$	$\pm 0.5$	%
	Load Regulation	$V_{IN}=V_{OUT}+1V (V_{IN} \geq 3V)$ , $1mA \leq I_{OUT} \leq 100mA$		10		mV
	Output Voltage Noise	10-100kHz, $C_{IN}=1\mu F$ , $I_{OUT}=1mA$ , UM15318S		170		$\mu V_{rms}$
PSRR	Power Supply Ripple Rejection	$V_{IN}=V_{OUT}+1V$ $I_{OUT}=10mA$	F=10Hz	55		dB
			F=100Hz	45		
			F=1KHz	45		

## Typical Performance Characteristics

Quiescent Current vs Input Voltage

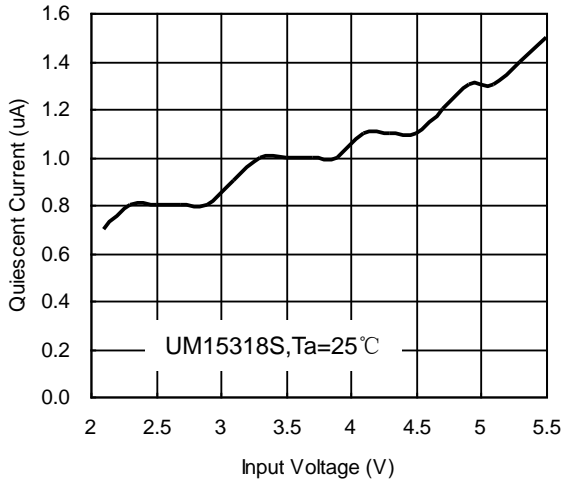

Quiescent Current vs Ambient Temperature

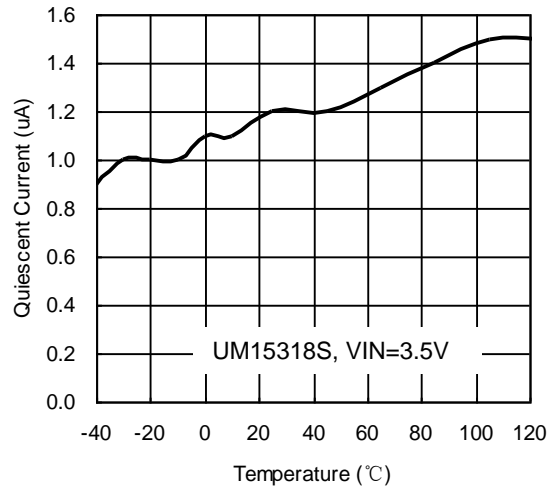

Output Voltage vs Input Voltage

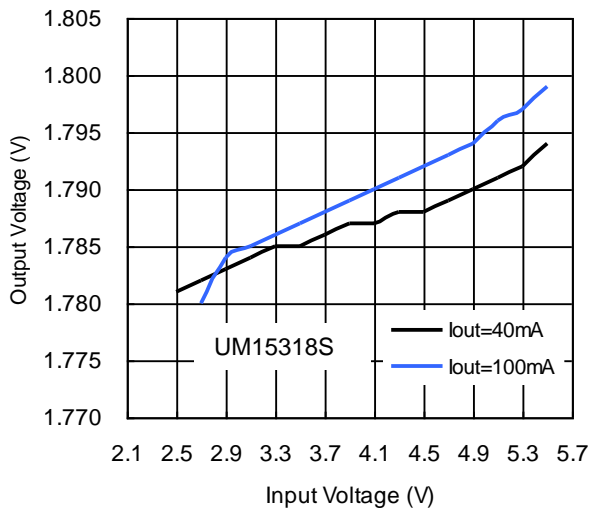

Output Voltage vs Ambient Temperature

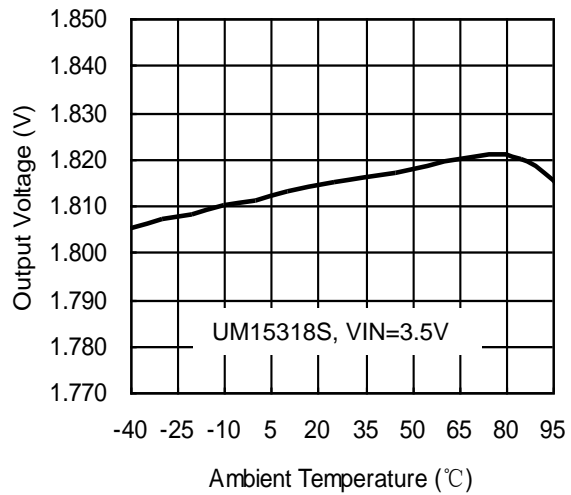

Output Voltage vs Output Current

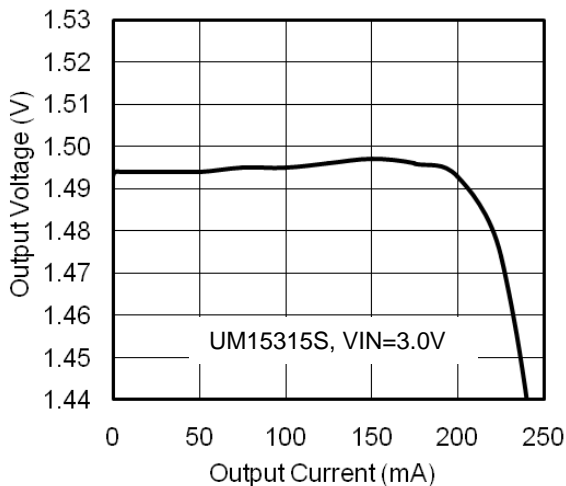

Output Voltage vs Output Current

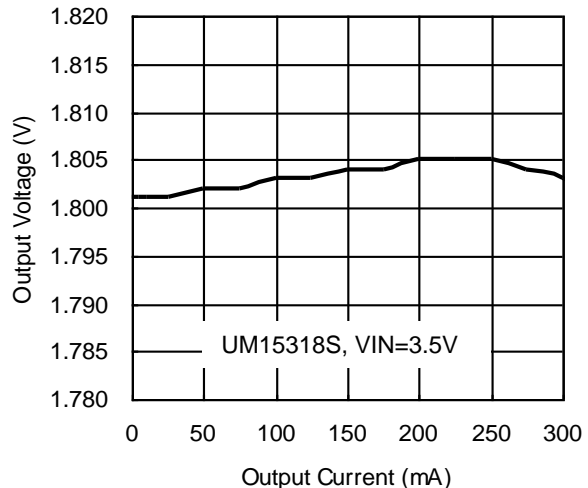

## Typical Performance Characteristics (Continued)

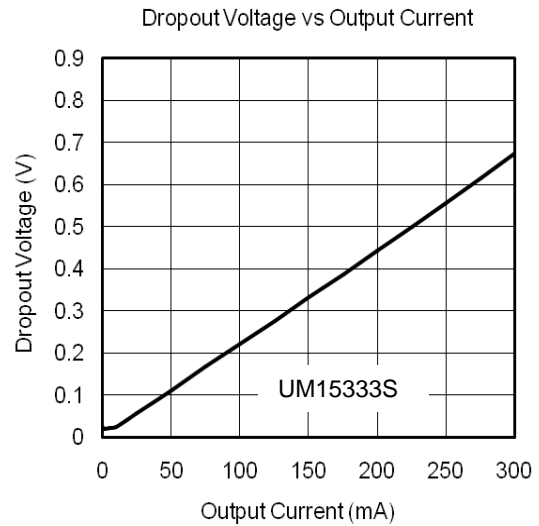
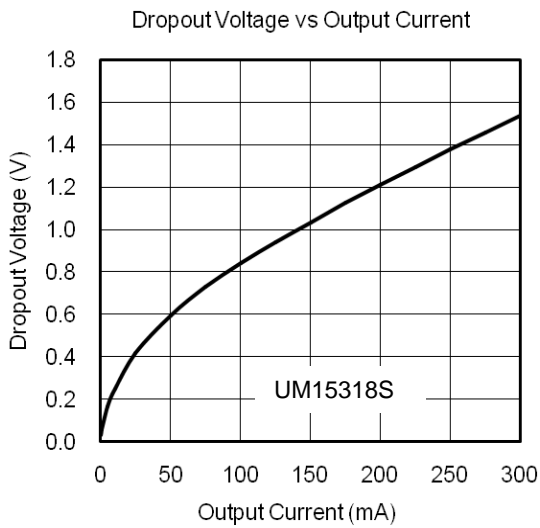
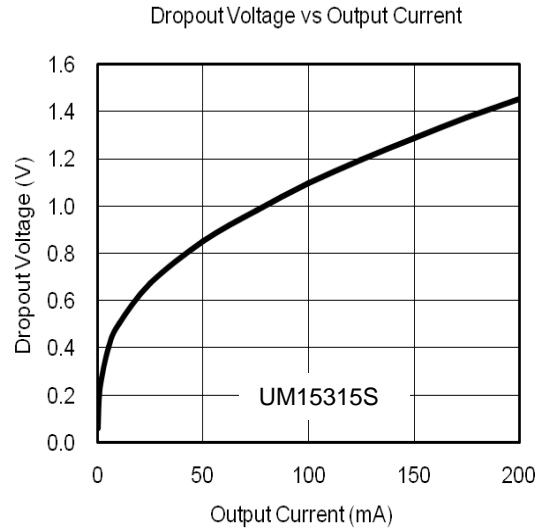
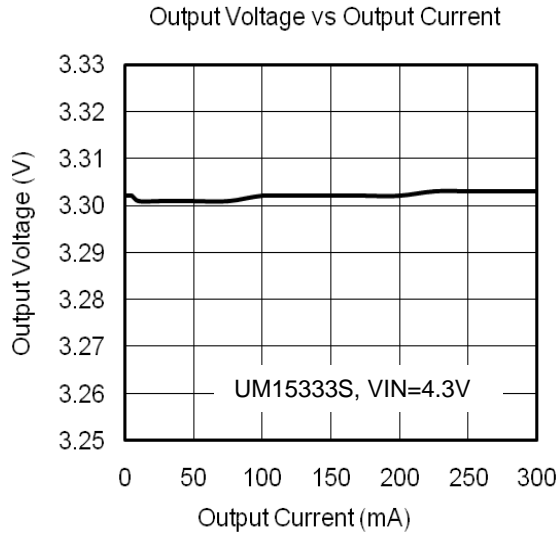

## Line Transient Response

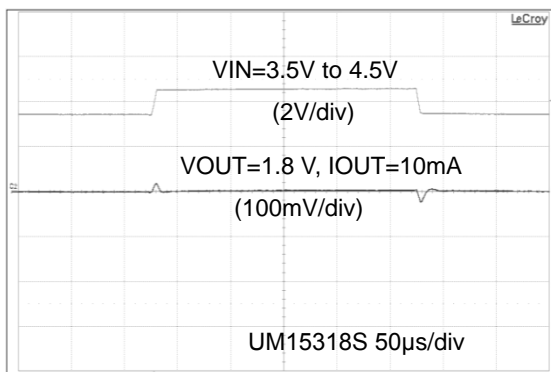

## Load Transient Response

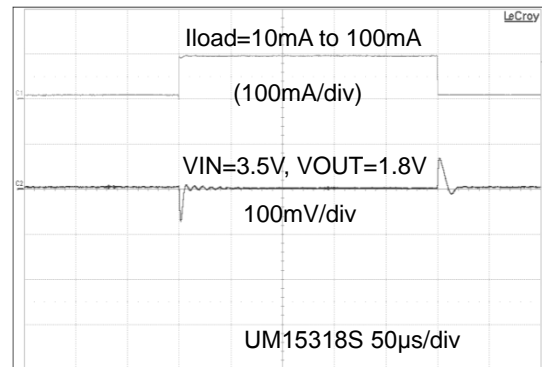

## Typical Application Circuit

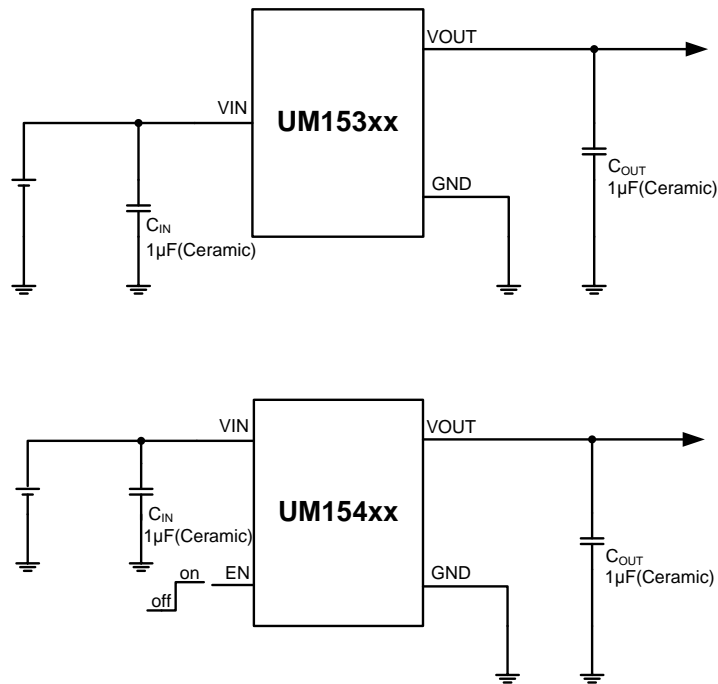

## Applications Information

### Output Capacitance and Transient Response

The UM153xx/UM154xx series regulators are designed to be stable with a wide range of output capacitors. The ESR of the output capacitor affects stability, most notably with small capacitors. A minimum output capacitor of 1µF with an ESR of 0.3Ω or less is recommended to ensure stability. The device's output transient response will be a function of output capacitance. Larger values of output capacitance decrease the peak deviations and provide improved transient response for larger load current changes. Extra consideration must be given to the use of ceramic capacitors. The X5R and X7R dielectrics result in more stable characteristics and are more suitable for use as the output capacitor. The X7R type has better stability across temperature, while the X5R is less expensive and is available in higher values.

### Thermal Protection

Thermal protection disables the output when the junction temperature rises to approximately +160 °C allowing the device to cool. When the junction temperature cools to approximately +140 °C the output circuit is again enabled.



## Package Information

### UM153xxS SOT23-3

#### Outline Drawing

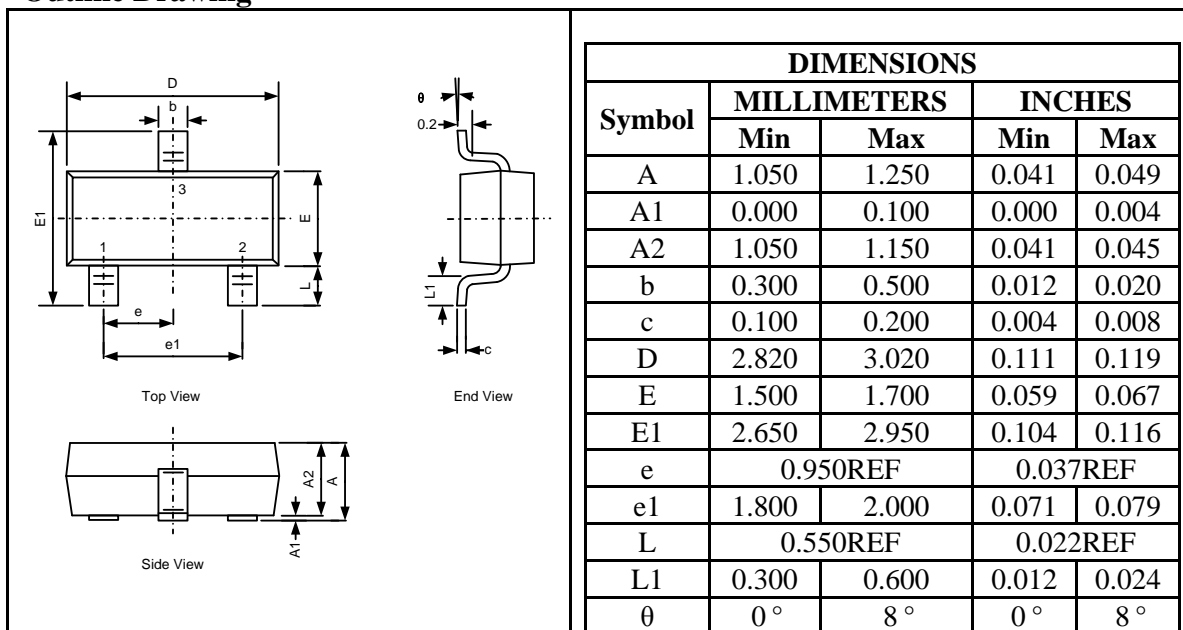

#### Land Pattern

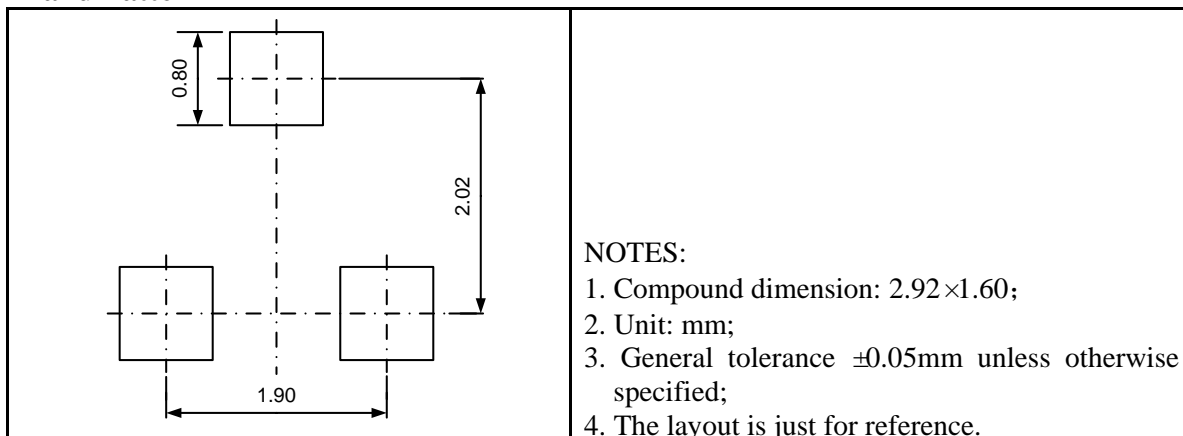

#### Tape and Reel Orientation



## UM153xxY SOT89-3

### Outline Drawing

Symbol	DIMENSIONS			
	MILLIMETERS		INCHES	
	Min	Max	Min	Max
A	1.400	1.600	0.055	0.063
b	0.320	0.520	0.013	0.020
b1	0.400	0.580	0.016	0.023
c	0.350	0.440	0.014	0.017
D	4.400	4.600	0.173	0.181
D1	1.55REF		0.061REF	
E	2.300	2.600	0.091	0.102
E1	3.940	4.250	0.155	0.167
e	1.5TYP		0.06TYP	
e1	3 TYP		0.118 TYP	
L	0.900	1.200	0.035	0.047

### Land Pattern

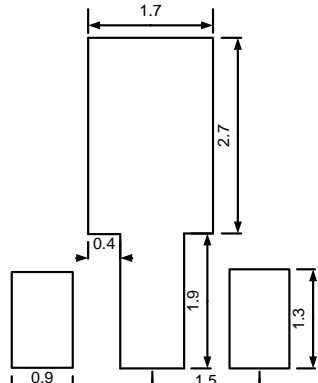
	<p>NOTES:</p> <ol style="list-style-type: none"> <li>Compound dimension: 4.5×2.45;</li> <li>Unit: mm;</li> <li>General tolerance ±0.05mm unless otherwise specified;</li> <li>The layout is just for reference.</li> </ol>
--	--

### Tape and Reel Orientation

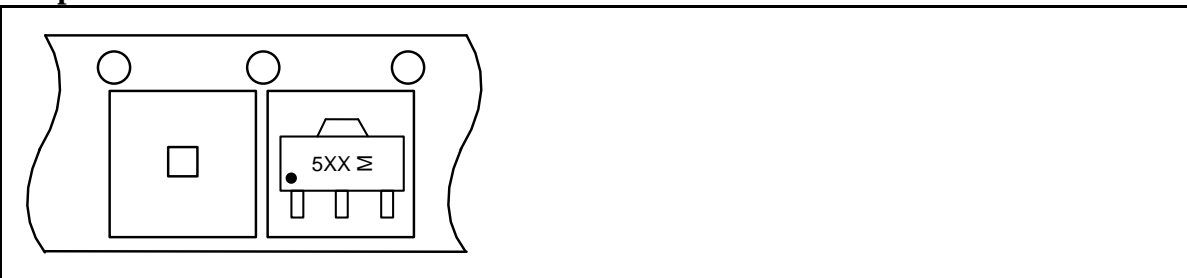

## UM154xxS SOT23-5

### Outline Drawing

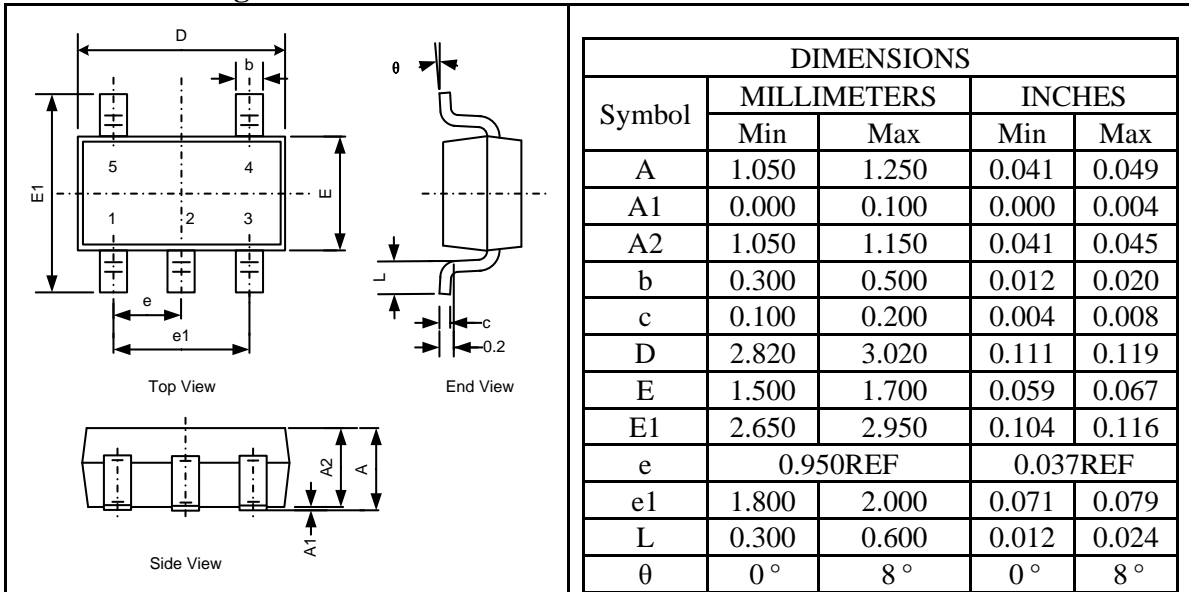

### Land Pattern

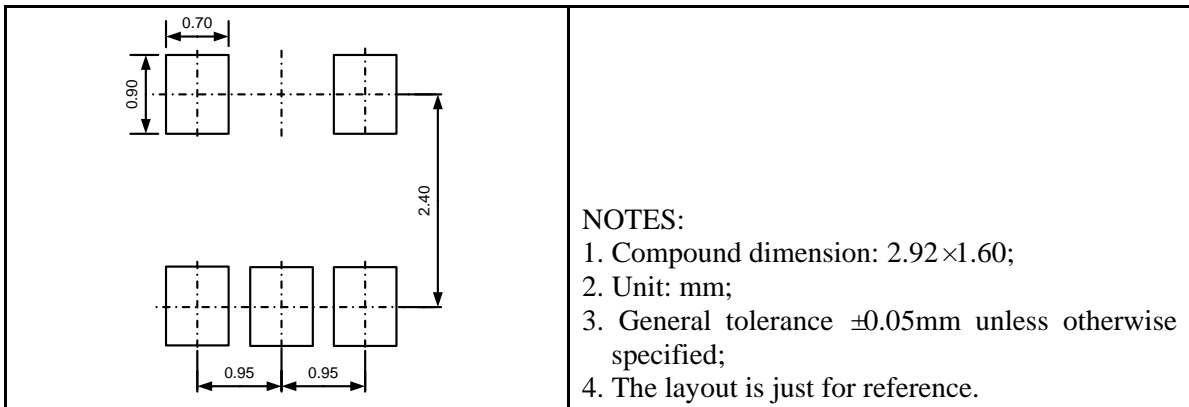

### Tape and Reel Orientation

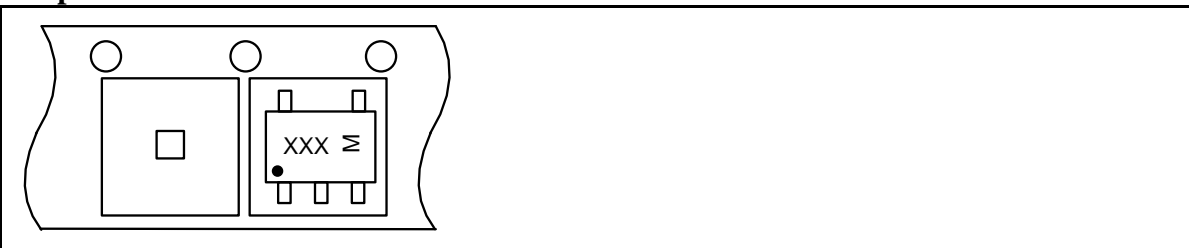

---

## IMPORTANT NOTICE

The information in this document has been carefully reviewed and is believed to be accurate. Nonetheless, this document is subject to change without notice. Union assumes no responsibility for any inaccuracies that may be contained in this document, and makes no commitment to update or to keep current the contained information, or to notify a person or organization of any update. Union reserves the right to make changes, at any time, in order to improve reliability, function or design and to attempt to supply the best product possible.



Union Semiconductor, Inc

Add: 2F, No. 3, Lane647 Songtao Road, Shanghai 201203

Tel: 021-51093966

Fax: 021-51026018

Website: [www.union-ic.com](http://www.union-ic.com)