

### FEATURES

- 0603, 0805, 0806 AND 1008 CASE SIZES
- HIGH DC CURRENT AND LOW DC RESISTANCE
- NEW "S" VERSION FOR INCREASED SATURATION CURRENT
- UPGRADED "H" VERSION FOR HIGHEST CURRENT
- REFLOW SOLDERING APPLICABLE
- PACKAGE FOR AUTOMATIC PICK-PLACE

**RoHS Compliant**

Includes all homogeneous materials

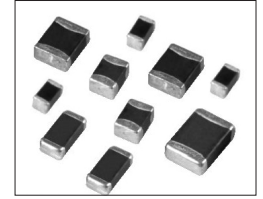

### SPECIFICATIONS

Specifications	Case Size			
	0603	0805	0806	1008
Inductance Range	0.47 $\mu$ H ~ 2.2 $\mu$ H	0.22 $\mu$ H ~ 10 $\mu$ H	0.47 $\mu$ H ~ 10 $\mu$ H	0.47 $\mu$ H ~ 10 $\mu$ H
Inductance Tolerance	$\pm$ 20% (M), $\pm$ 30% (N)			
Operating Temperature Range	-40°C ~ +85°C			
Self Resonant Frequency, DC Resistance, Rated DC Current and Inductance Tolerance	See Standard Values and Specifications Table			

Note: Extended values, tolerances, and enhanced versions are available please contact NIC for more details.

### DIMENSIONS (mm)

Case Size	L	W	H	P
0603	1.6 $\pm$ 0.15	0.8 $\pm$ 0.15	0.5 $\pm$ 0.1	0.3 $\pm$ 0.2
			0.8 $\pm$ 0.15	
0805	2.0 +0.3/-0.1	1.25 $\pm$ 0.2	0.5 $\pm$ 0.1	0.5 $\pm$ 0.3
			0.9 $\pm$ 0.1	
			1.25 $\pm$ 0.2	
0806	2.0 +0.3/-0.1	1.6 $\pm$ 0.2	0.9 $\pm$ 0.1	0.5 $\pm$ 0.3
			1.1 $\pm$ 0.1	
1008	2.5 $\pm$ 0.2	2.0 +0.3/-0.1	0.9 $\pm$ 0.1	0.5 $\pm$ 0.3
			1.1 $\pm$ 0.1	

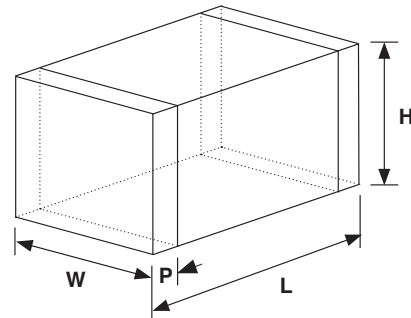

### PART NUMBER SYSTEM

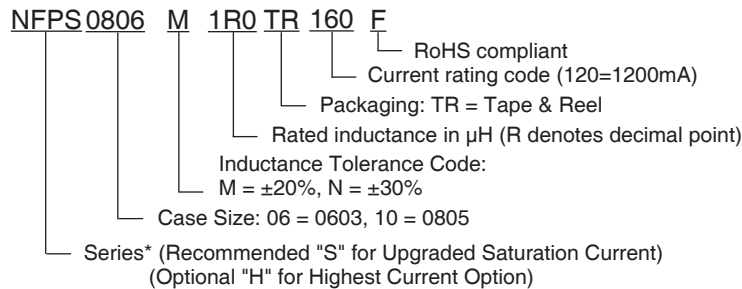

\*NFP vs. NFPS vs. NFPH Performance Comparison

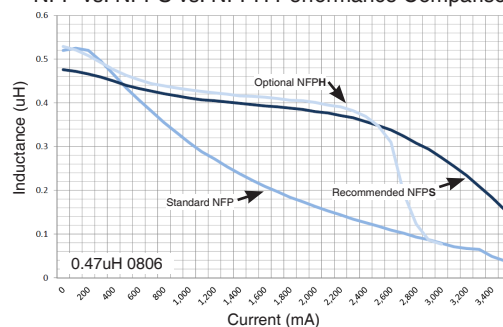

## NFP0603 SERIES

## 0603 CASE SIZE

NIC Partnumber	Inductance (μH)	Tolerance	Test Frequency	SRF MHz (min.)	DC Resistance (Ω)	I <sub>rms</sub> (mA)	I <sub>sat</sub> (mA)	Component Thickness (mm)
NFP0603NR47TR90F	0.47	±30% (N)	1MHz	105	0.19 ± 25%	900	-	0.5 ± 0.1
NFPS0603_R22TR125F	0.22	±20% (M), ±30% (N)		200	0.10 ± 25%	1250	1600	0.8 ± 0.15
NFPS0603_R33TR120F	0.33	±20% (M), ±30% (N)		190	0.13 ± 25%	1200	1500	
NFP0603NR47TR120F	0.47	±30% (N)		105	0.12 ± 25%	1200	-	
NFPS0603_R47TR110F	0.47	±20% (M), ±30% (N)		180	0.15 ± 25%	1100	1200	
NFP0603NR68TR100F	0.68	±30% (N)		90	0.16 ± 25%	1000	-	
NFPS0603_R68TR115F	0.68	±20% (M), ±30% (N)		160	0.18 ± 25%	1150	1100	
NFP0603N1R0TR95F	1.0	±30% (N)		60	0.20 ± 25%	950	-	
NFPS0603_1R0TR100F	1.0	±20% (M), ±30% (N)		125	0.20 ± 25%	1000	800	
NFPS0603_1R5TR90F	1.5	±20% (M), ±30% (N)		100	0.23 ± 25%	900	500	
NFP0603N2R2TR75F	2.2	±30% (N)		40	0.30 ± 25%	750	-	
NFPS0603_2R2TR85F	2.2	±20% (M), ±30% (N)		80	0.30 ± 25%	850	300	

Maximum +40°C temperature rise at I<sub>rms</sub>. Maximum -30% inductance drop from initial measured value at I<sub>sat</sub>.

## NFP0805 SERIES

## 0805 CASE SIZE

NIC Partnumber	Inductance (μH)	Tolerance	Test Frequency	SRF MHz (min.)	DC Resistance (Ω)	I <sub>rms</sub> (mA)	I <sub>sat</sub> (mA)	Component Thickness (mm)
NFP0805MR22TR150F	0.22	±20% (M)	1MHz	100	0.09 ± 25%	1500	-	0.5 ± 0.1
NFP0805_R47TR110F	0.47	±20% (M), ±30% (N)		100	0.12 ± 25%	1100	-	
NFPS0805_R47TR110F	0.47	±20% (M), ±30% (N)		80			1300	
NFP0805_1R0TR80F	1.0	±20% (M), ±30% (N)		60	0.19 ± 25%	800	-	
NFPS0805_1R0TR80F	1.0	±20% (M), ±30% (N)		40			700	
NFP0805_1R5TR70F	1.5	±20% (M), ±30% (N)		50	0.26 ± 25%	700	-	
NFPS0805_1R5TR70F	1.5	±20% (M), ±30% (N)		35			500	
NFP0805_2R2TR60F	2.2	±20% (M), ±30% (N)		40	0.34 ± 25%	600	-	
NFPS0805_2R2TR60F	2.2	±20% (M), ±30% (N)		30	0.32 ± 25%		350	
NFP0805_R47TR120F	0.47	±20% (M), ±30% (N)		100	0.09 ± 25%	1200	-	
NFPS0805_R47TR150F		±20% (M), ±30% (N)		100	0.08 ± 25%	1500	1200	
NFP0805_1R0TR100F	1.0	±20% (M), ±30% (N)		60	0.11 ± 25%	1000	-	
NFPS0805_1R0TR130F		±20% (M), ±30% (N)		60	0.11 ± 25%	1300	1150	
NFP0805_1R5TR90F	1.5	±20% (M), ±30% (N)		50	0.16 ± 25%	900	-	
NFPS0805_1R5TR110F		±20% (M), ±30% (N)		50	0.16 ± 25%	1100	800	
NFP0805_2R2TR80F	2.2	±20% (M), ±30% (N)		40	0.25 ± 25%	800	-	
NFPS0805_2R2TR90F		±20% (M), ±30% (N)		40	0.20 ± 25%	900	500	
NFP0805_3R3TR90F	3.3	±20% (M), ±30% (N)		30	0.19 ± 25%	900	-	
NFPS0805_3R3TR90F		±20% (M), ±30% (N)		30	0.20 ± 25%	900	350	
NFP0805_4R7TR80F	4.7	±20% (M), ±30% (N)		30	0.25 ± 25%	800	-	
NFPS0805_4R7TR80F		±20% (M), ±30% (N)	30	0.25 ± 25%	800	280		
NFP0805M100TR50F	10	±20% (M)	15	0.5 ± 30%	500	-	1.25 ± 0.2	

Maximum +40°C temperature rise at I<sub>rms</sub>. Maximum -30% inductance drop from initial measured value at I<sub>sat</sub>.



Note: Extended values, tolerances, and enhanced versions are available please contact NIC for more details.

## NFP0806 SERIES

## 0806 CASE SIZE

NIC Partnumber	Inductance (μH)	Tolerance	Test Frequency	SRF MHz (min.)	DC Resistance (Ω)	I <sub>rms</sub> (mA)	I <sub>sat</sub> (mA)	Component Thickness (mm)
NFP0806_R47TR160F	0.47	±20% (M), ±30% (N)	1MHz	100	0.06 ± 25%	1600	-	0.9 ± 0.1
NFPS0806MR47TR150F		20%			0.08 ± 25%	1500	1600	
NFPH0806MR47TR230F		±20% (M), ±30% (N)			90	0.04 ± 25%	2300	
NFPH0806MR68TR180F	0.68	±20% (M), ±30% (N)		80	0.06 ± 25%	1800	2000	
NFP0806_1R0TR140F	1.0	±20% (M), ±30% (N)		70	0.09 ± 25%	1400	-	
NFPS0806M1R0TR140F		20%		1200	1800			
NFPH0806M1R0TR150F		±20% (M), ±30% (N)		60	0.07 ± 25%	1500	1800	
NFP0806_1R5TR120F	1.5	±20% (M), ±30% (N)		60	0.11 ± 25%	1200	-	
NFPS0806M1R5TR120F		20%		700	700			
NFP0806_2R2TR120F	2.2	±20% (M), ±30% (N)		50	0.11 ± 25%	1200	-	
NFPS0806M2R2TR120F		20%		500	500			
NFP0806_3R3TR120F	3.3	±20% (M), ±30% (N)		40	0.12 ± 25%	1200	-	
NFPS0806M3R3TR120F		20%		330	330			
NFP0806_4R7TR110F	4.7	±20% (M), ±30% (N)		30	0.14 ± 25%	1100	-	
NFPS0806M4R7TR110F		20%		220	220			
NFP0806M100TR80F	10	±20% (M)	15	0.25 ± 25%	800	-	1.1 ± 0.1	

Maximum +40°C temperature rise at I<sub>rms</sub>. Maximum -30% inductance drop from initial measured value at I<sub>sat</sub>.

## NFP1008 SERIES

## 1008 CASE SIZE

NIC Partnumber	Inductance (μH)	Tolerance	Test Frequency	SRF MHz (min.)	DC Resistance (Ω)	I <sub>rms</sub> (mA)	I <sub>sat</sub> (mA)	Component Thickness (mm)	
NFP1008_R47TR180F	0.47	±20% (M), ±30% (N)	1MHz	100	0.04 ± 25%	1800	-	0.9 ± 0.1	
NFPS1008_R47TR180F		±20% (M), ±30% (N)		105			1500		
NFP1008_1R0TR160F	1.0	±20% (M), ±30% (N)		60	0.06 ± 25%	1600	-		
NFPS1008_1R0TR160F		±20% (M), ±30% (N)		70			1400		
NFP1008_1R5TR150F	1.5	±20% (M), ±30% (N)		50	0.07 ± 25%	1500	-		
NFPS1008_1R5TR150F		±20% (M), ±30% (N)		65			1200		
NFP1008_2R2TR130F	2.2	±20% (M), ±30% (N)		40	0.08 ± 25%	1300	-		
NFPS1008_2R2TR130F		±20% (M), ±30% (N)		55			850		
NFP1008_3R3TR120F	3.3	±20% (M), ±30% (N)		30	0.10 ± 25%	1200	-		
NFPS1008_3R3TR120F		±20% (M), ±30% (N)		450			450		
NFP1008_4R7TR110F	4.7	±20% (M), ±30% (N)		25	0.11 ± 25%	1100	-		
NFPS1008_4R7TR110F		±20% (M), ±30% (N)		320			320		
NFP1008_1R0TR150F	1.0	±20% (M), ±30% (N)		70	0.09 ± 25%	1500	-		1.1 ± 0.1
NFP1008_2R2TR100F	2.2	±20% (M), ±30% (N)		40	0.12 ± 25%	1000	-		
NFP1008_3R3TR100F	3.3	±20% (M), ±30% (N)		30	0.12 ± 25%	1000	-		
NFP1008_4R7TR90F	4.7	±20% (M), ±30% (N)	25	0.14 ± 25%	900	-			
NFP1008M100TR80F	10	±20% (M)	15	0.30 ± 30%	800	-			

Maximum +40°C temperature rise at I<sub>rms</sub>. Maximum -30% inductance drop from initial measured value at I<sub>sat</sub>.



## ENVIRONMENTAL CHARACTERISTICS

Test	Specification	Test Method & Condition
Resistance to Soldering Heat	No Mechanical Damage Inductance: $\pm 20\%$ of initial value (parts should be stabilized at room temperature for 2 hours prior to testing)	+260°C for 5 seconds
Low Frequency Vibration		Cycle 10Hz ~ 55Hz ~ 10Hz (1 minute), 2 hours each axis (X, Y, Z)
Thermal Shock		Cycle -40°C for 30 min. > +85°C 30 min., 100 cycles
Humidity		+60°C, 90% ~ 95%RH, 1,000 hours
Low Temperature Storage		-40°C for 1,000 hours
High Temperature Load Life		+85°C for 1,000 hours

## LAND PATTERN DIMENSIONS

Series	A	B	C
NFP0603	0.6 ~ 0.8	0.6 ~ 0.8	0.6 ~ 0.8
NFP0805	0.8 ~ 1.2	0.9 ~ 1.6	0.8 ~ 1.2
NFP0806	0.8 ~ 1.2	1.2 ~ 2.0	0.8 ~ 1.2
NPF1008	0.6 ~ 1.0	1.8 ~ 2.2	1.0 ~ 1.4

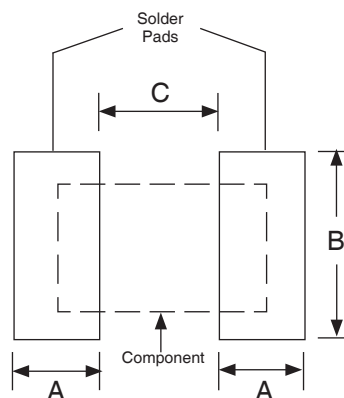

## REFLOW SOLDERING PROFILE

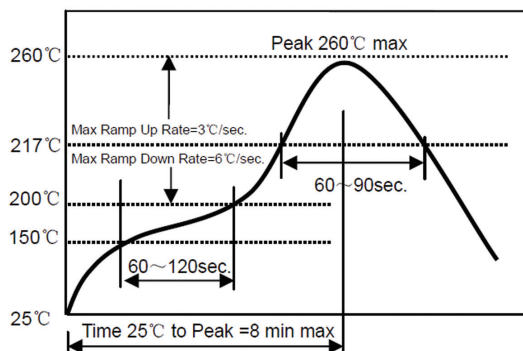

## COMPOSITION

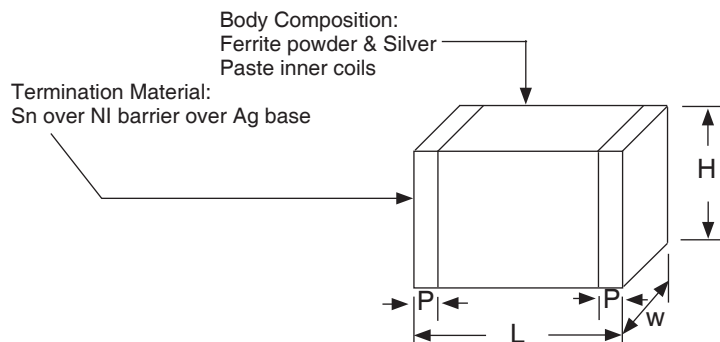

## CARRIER DIMENSIONS & REEL QUANTITY (mm)

TYPE	Part Thickness	A	B	K max.	T max.	Carrier Material	Reel Qty
NFP0603	0.5	1.0 ± 0.2	1.8 ± 0.2	-	0.8	Paper	5,000
	0.8				1.1		4,000
NFP0805	0.5	1.55 ± 0.10	2.30 ± 0.10	1.45	0.8		Plastic
	0.9			1.45		3,000	
NFP0806	1.25	1.90 ± 0.10	2.30 ± 0.10	1.75	0.3		
	0.9			1.45			
NFP1008	1.1	2.30 ± 0.10	2.80 ± 0.10	1.75	0.3		
	0.9			1.45			

### PAPER CARRIER DIMENSIONS (mm)

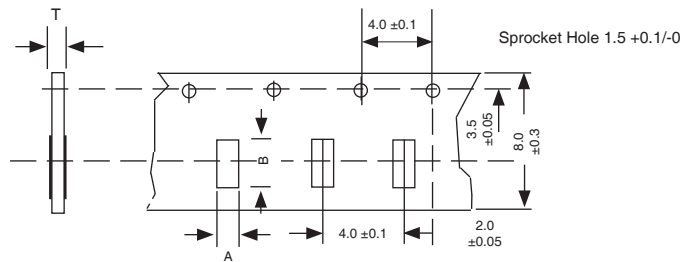

### EMBOSSED PLASTIC CARRIER DIMENSIONS (mm)

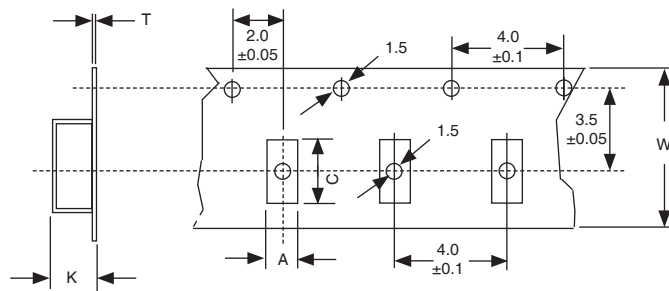

### REEL DIMENSIONS (mm):

