

LR2002A/L

HIGH-VOLTAGE, HIGH-CURRENT DARLINGTON ARRAYS

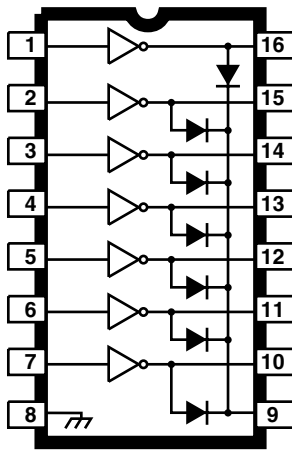

Note that the LR2002A series (dual in-line package) and LR2002L series (small-outline IC package) are electrically identical and share a common terminal number assignment.

ABSOLUTE MAXIMUM RATINGS

Output Voltage, V_{CE}	50 V
Input Voltage, V_{IN}	30 V
Continuous Output Current, I_C	500 mA
Continuous Input Current, I_{IN}	25 mA
Power Dissipation, P_D (one Darlington pair)	1.0 W
(total package)	See Graph
Operating Temperature Range, T_A	-40°C to +85°C
Storage Temperature Range, T_S	-55°C to +150°C

FEATURES

- 14-25V PMOS Compatible Inputs
- Output Current to 500 mA
- Output Voltage to 50 V
- Transient-Protected Outputs
- Dual In-Line Plastic Package or Small-Outline IC Package

Ideally suited for interfacing between low-level logic circuitry and multiple peripheral power loads, the Series LR2002A/L high-voltage, high-current Darlington arrays feature continuous load current ratings to 500 mA for each of the seven drivers. At an appropriate duty cycle depending on ambient temperature and number of drivers turned ON simultaneously, typical power loads totaling over 120 W (350 mA x 7, 50 V) can be controlled. Typical loads include relays, solenoids, stepping motors, magnetic print hammers, multiplexed LED and incandescent displays, and heaters. All devices feature open-collector outputs with integral clamp diodes.

The LR2002A/L have series input resistors selected for operation directly with 14-25V PMOS. These devices will handle numerous interface needs - particularly those beyond the capabilities of standard logic buffers.

The LR2002A/L are the standard Darlington Array. The outputs are capable of sinking 500 mA and will withstand at least 50V in the OFF state. Outputs may be paralleled for higher load current capability.

These Darlington arrays are furnished in 16-pin dual in-line plastic packages (suffix "A") and 16-lead surface-mountable SOICs (suffix "L"). All devices are pinned with outputs opposite inputs to facilitate ease of circuit board layout. All devices are rated for operation over the temperature range of -40°C to +85°C.

PARTIAL SCHEMATICS

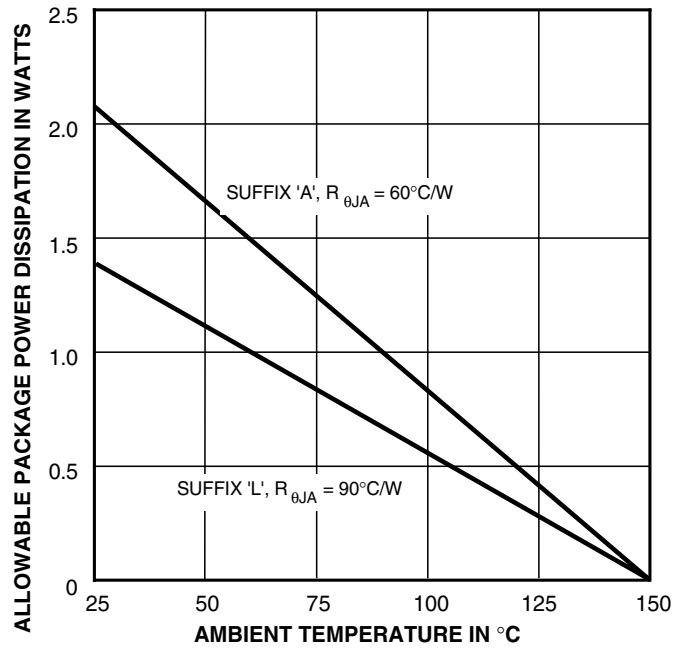
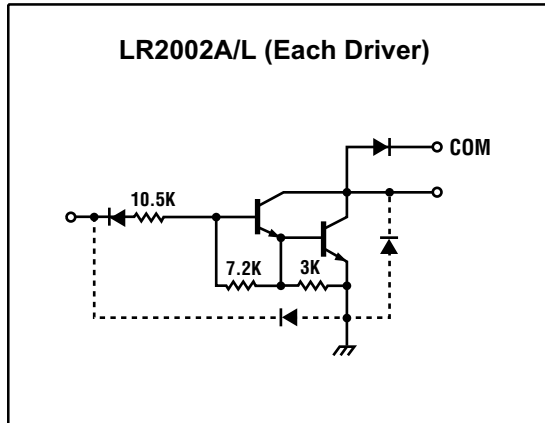

Recommended Operating Conditions (Ta = -40 to 85°C)

Characteristic		Symbol	Test Condition	Min	Typ.	Max	Unit	
Output voltage		V _{CE}		0	—	50	V	
Output current	A	I _C	T _{pw} = 25 ms 7 Circuits Ta = 85°C Tj = 120°C	Duty = 10%	0	—	350	mA/ch
	L			Duty = 50%	0	—	100	
				Duty = 10%	0	—	300	
				Duty = 50%	0	—	90	
Input voltage		V _{IN}		0	—	24	V	
Input voltage (output on)		V _{IN(ON)}	I _{OUT} = 400 mA h _{FE} = 800	2.8	—	24	V	
Input voltage (output off)		V _{IN(OFF)}		0	—	0.7	V	
Clamp diode reverse voltage		V _R		—	—	50	V	
Clamp diode forward current		I _F		—	—	350	mA	
Power dissipation	A	P _D	Ta = 85°C	—	—	0.76	W	
	L		Ta = 85°C	—	—	0.65		

LR2002A/L

ELECTRICAL CHARACTERISTICS at +25°C (unless otherwise noted).

Characteristic	Symbol	Test Fig.	Applicable Devices	Test Conditions	Limits			
					Min.	Typ.	Max.	Units
Output Leakage Current	I _{CEX}	1		V _{CE} = 50 V, T _A = 25°C	—	< 1	50	μA
				V _{CE} = 50 V, T _A = 70°C	—	< 1	100	μA
Collector-Emitter Saturation Voltage	V _{CE(SAT)}	2		I _C = 100 mA, I _B = 250 μA	—	0.9	1.1	V
				I _C = 200 mA, I _B = 350 μA	—	1.1	1.3	V
				I _C = 350 mA, I _B = 500 μA	—	1.3	1.6	V
Input Current	I _{IN(ON)}	3		V _{IN} = 17 V	—	0.82	1.25	mA
	I _{IN(OFF)}	4		I _C = 500 μA, T _A = 70°C	50	65	—	μA
Input Voltage	V _{IN(ON)}	5		V _{CE} = 2.0 V, I _C = 300 mA	—	—	13	V
Input Capacitance	C _{IN}	—	All		—	15	25	pF
Turn-On Delay	t _{PLH}	8	All	0.5 E _{IN} to 0.5 E _{OUT}	—	0.25	1.0	μs
Turn-Off Delay	t _{PHL}	8	All	0.5 E _{IN} to 0.5 E _{OUT}	—	0.25	1.0	μs
Clamp Diode Leakage Current	I _R	6	All	V _R = 50 V, T _A = 25°C	—	—	50	μA
				V _R = 50 V, T _A = 70°C	—	—	100	μA
Clamp Diode Forward Voltage	V _F	7	All	I _F = 350 mA	—	1.7	2.0	V

Complete part number includes suffix to identify package style: A = DIP, L = SOIC.

TEST FIGURES

FIGURE 1

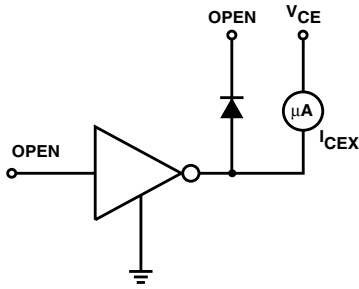

FIGURE 2

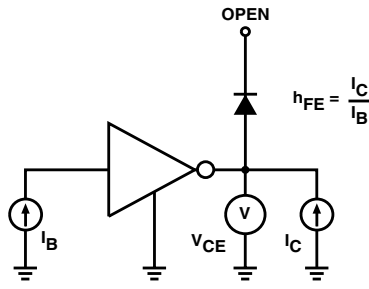

FIGURE 3

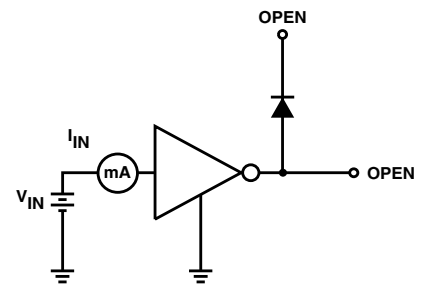

FIGURE 4

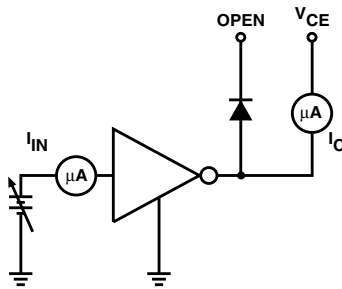

FIGURE 5

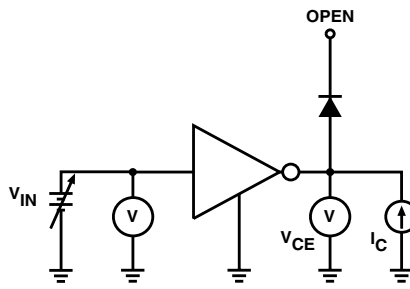

FIGURE 6

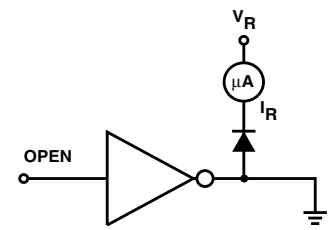

FIGURE 7

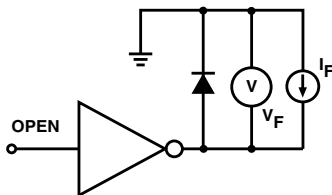
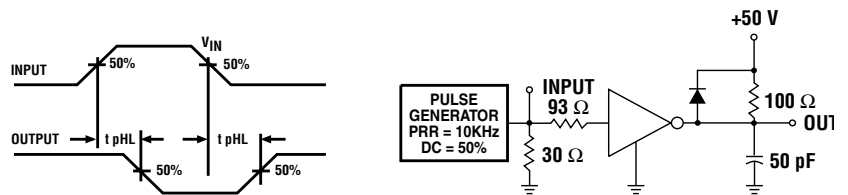
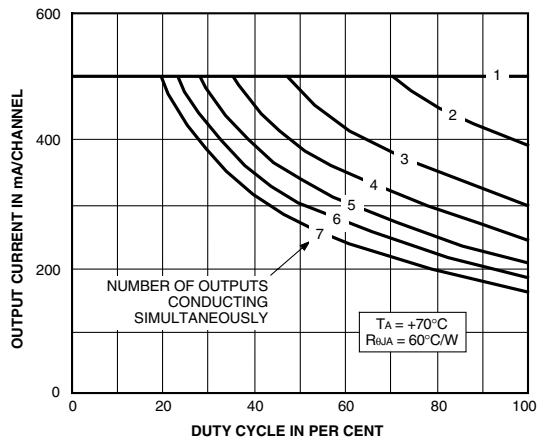

FIGURE 8



ALLOWABLE COLLECTOR CURRENT AS A FUNCTION OF DUTY CYCLE

(Dual In-line-Packaged Devices, Suffix 'A')



(Small-Outline-Packaged Devices, Suffix 'L')

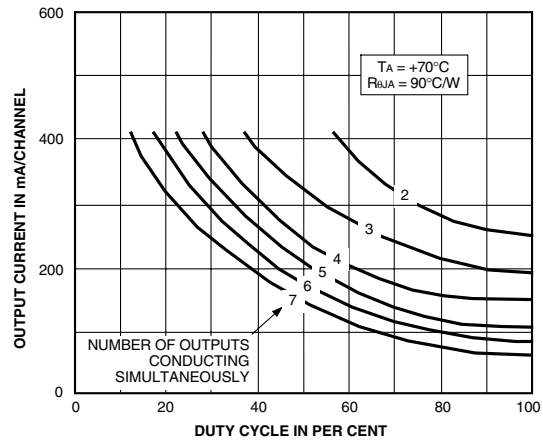

SATURATION VOLTAGE AS A FUNCTION OF COLLECTOR CURRENT

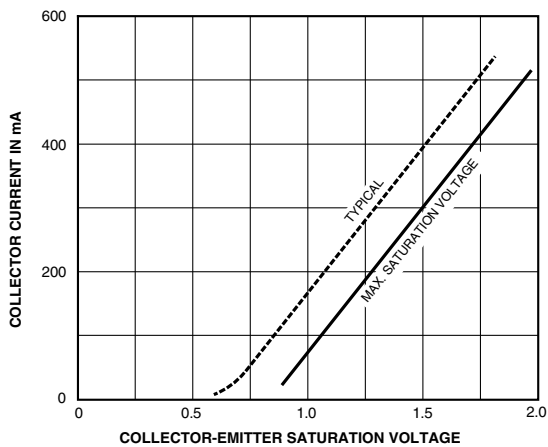

COLLECTOR CURRENT AS A FUNCTION OF INPUT CURRENT

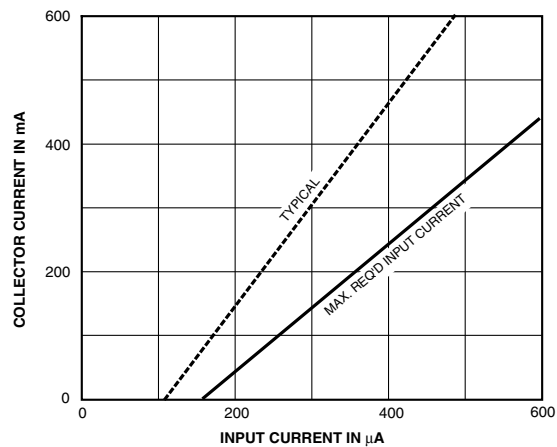

INPUT CURRENT AS A FUNCTION OF INPUT VOLTAGE

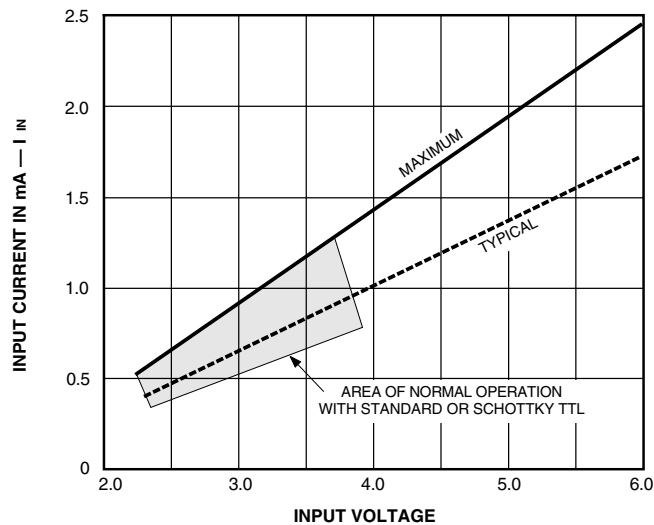

TYPICAL APPLICATIONS

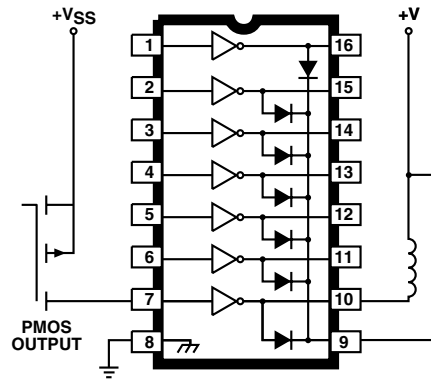

PACKAGE DESIGNATOR "A"

Dimensions in Inches
(controlling dimensions)

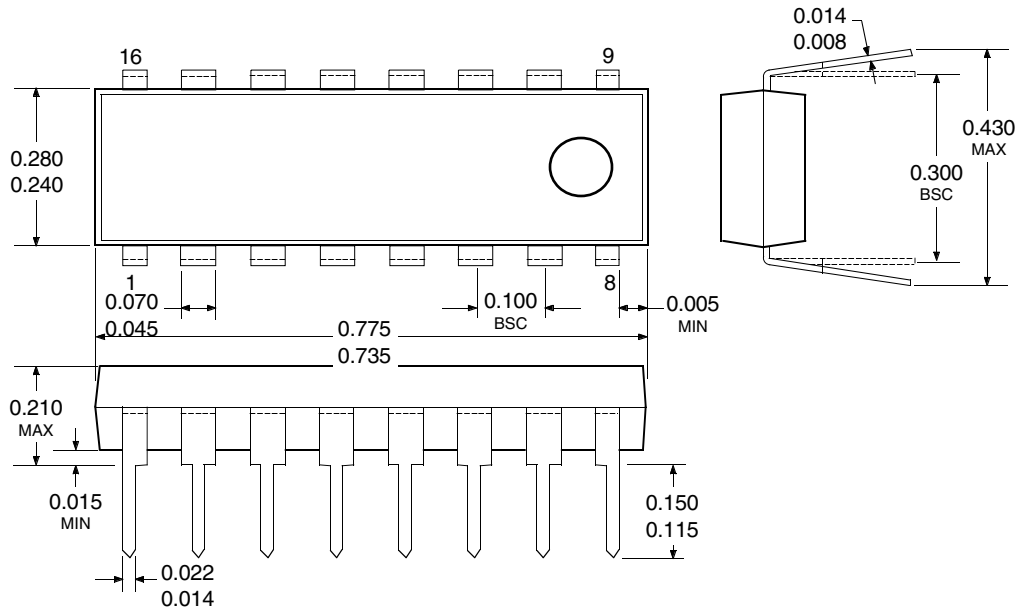

Dimension in Millimeters
(for reference only)

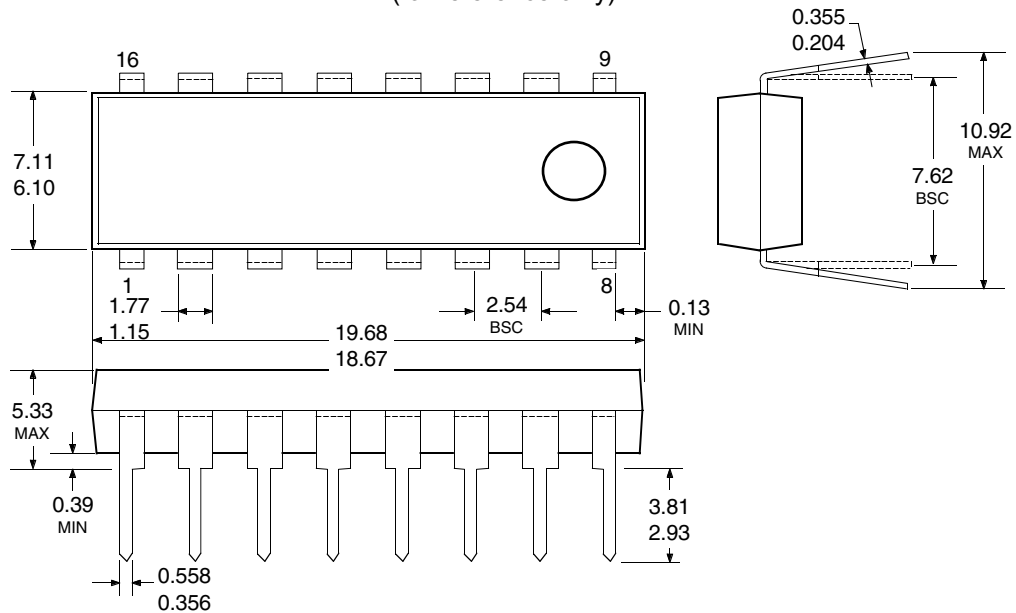

PACKAGE DESIGNATOR "L"

Dimensions in Inches
(for reference only)

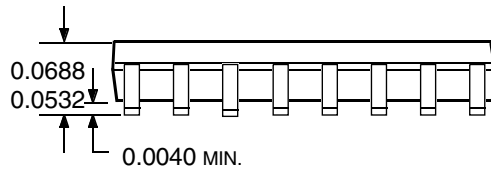
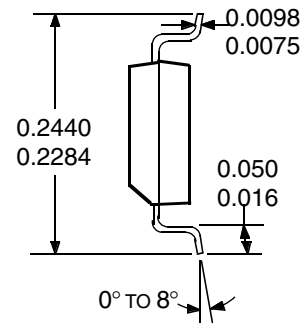
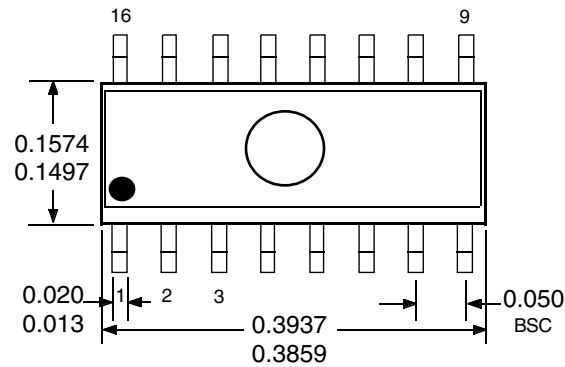

Dimension in Millimeters
(controlling dimensions)

