

LQ231U1LW31 LCD Module

Product Specification

September 2009

Normally Black UXGA module featuring 500 nits brightness with 600:1 contrast; LED backlight, symmetrical wide viewing cone, 8 ms response time, anti-glare and 2H hard coating.

PREPARED BY : DATE	<h1>SHARP</h1> <p>MOBILE LIQUID CRYSTAL DISPLAY GROUP SHARP CORPORATION</p> <h2>SPECIFICATION</h2>	SPEC No. LD-21810
APPROVED BY : DATE		FILE No.
		ISSUE : Sep. 01. 2009
		PAGE : 22 pages
		APPLICABLE GROUP MOBILE LIQUID CRYSTAL DISPLAY GROUP

DEVICE SPECIFICATION FOR

TFT-LCD Module

MODEL No.

LQ231U1LW31

These parts have corresponded with the RoHS directive.

CUSTOMER'S APPROVAL

DATE _____

BY _____

PRESENTED

BY *T. Naka*

T. Naka
DIVISION DEPUTY GENERAL MANAGER
AND DEPARTMENT GENERAL MANAGER
ENGINEERING DEPT. I
MOBILE LIQUID CRYSTAL DISPLAY DIVISION III
MOBILE LIQUID CRYSTAL DISPLAY GROUP
SHARP CORPORATION

1. Application

This specification sheets applies to the color TFT-LCD module LQ231U1LW31.

These specification sheets are the proprietary product of SHARP CORPORATION ("SHARP") and include materials protected under copyright of SHARP. Do not reproduce or cause any third party to reproduce them in any form or by any means, electronic or mechanical, for any purpose, in whole or in part, without the express written permission of SHARP.

The application example published in this specification sheets is used to explain a typical application example that uses the product of our company. It is not the one to permit the guarantee or the execution right to the execution of an industrial property and other right according to this technological material. Moreover, SHARP assumes no responsibility for any problem related to the third party and the industrial property, etc. occurring by having used the product of our company.

The device listed in these specification sheets was designed and manufactured for use in general electronic equipment.

In case of using the device for applications such as control and safety equipment for transportation (controls of aircraft, trains, automobiles, etc.), rescue and security equipment and various safety related equipment which require higher reliability and safety, take into consideration that appropriate measures such as fail-safe functions and redundant system design should be taken.

Do not use the device for equipment that requires an extreme level of reliability, such as aerospace applications, telecommunication equipment (trunk lines), nuclear power control equipment and medical or other equipment for life support.

SHARP assumes no responsibility for any damage resulting from the use of the device which does not comply with the instructions and the precautions specified in these specification sheets.

Confirm "11. Handling Precautions " item when you use the device.

Contact and consult with a SHARP sales representative for any questions about this device.

2. Overview

This module is a color active matrix LCD module incorporating amorphous silicon TFT (Thin Film Transistor). It is composed of a color TFT-LCD panel, driver ICs, control circuit, power supply circuit and a back light unit. Graphics and texts can be displayed on a 1600 × RGB × 1200 dots panel with about 16,777,216 colors by using LDI (LVDS Display Interface) and supplying +5.0V DC supply voltages for TFT-LCD panel driving and applying +12.0V DC supply voltage for LED backlight-driving DC/DC converter.

It is a wide viewing-angle-module, high brightness(500cd/m²) and high speed response specification.

These LCD modules have corresponded with the RoHS directive.

3. Mechanical Specifications

Parameter	Specifications	Unit
Display size	59 (23.1") Diagonal	cm
Active area	470.4 (H) × 352.8 (V)	mm
Pixel format	1600 (H) × 1200 (V)	Pixel
	(1 pixel = R+G+B dots)	
Aspect ratio	4:3	
Pixel pitch	0.294 (H) × 0.294 (V)	mm
Pixel configuration	R, G, B vertical stripe	
Display mode	Normally black	
Unit outline dimensions *1	530.0(W) × 431.5(H) × 23.9(D)TYP	mm
Mass	4,500 (max)	g
Surface treatment (Haze value)	Anti-glare coating : (Haze value 40%, Hardness 2H)	

*1.Note: excluding back light cables and connectors.

The thickness of module (D) doesn't contain the projection.

Outline dimensions are shown in Fig.1.

4. Input Terminals

4-1. TFT-LCD panel driving

CN1 (Interface signals and +5.0V power supply)

Using connectors : FI-WE31P-HFE (Japan Aviation Electronics Industry, Limited)

Corresponding connectors : FI-W31M (Japan Aviation Electronics Industry, Limited)

: FI-C3-A3-15000(Contact)

Using LVDS receiver : Type contained in a control IC

(DS90CF386 (NS Corporation) or equivalent)

Corresponding LDI Transmitter : DS90C387 (NS Corporation) or equivalent)

Non-DC Balanced Mode

Table 4-1-1 LDI Interface signals

Pin No.	Symbol	Function	Remark
1	Vcc	+5V power supply	
2	Vcc	+5V power supply	
3	Vcc	+5V power supply	
4	Vcc	+5V power supply	
5	GND	GND	
6	GND	GND	
7	GND	GND	
8	NC	NC	
9	GMCH	Gamma control(High)	
10	GMCL	Gamma control(Low)	
11	RxO0-	Receiver signal of LDI (O0-)	LDI
12	RxO0+	Receiver signal of LDI (O0+)	LDI
13	RxO1-	Receiver signal of LDI (O1-)	LDI
14	RxO1+	Receiver signal of LDI (O1+)	LDI
15	RxO2-	Receiver signal of LDI (O2-)	LDI
16	RxO2+	Receiver signal of LDI (O2+)	LDI
17	RxO-	Receiver CLK of LDI(OC-)	LDI
18	RxO+	Receiver CLK of LDI(OC+)	LDI
19	RxO3-	Receiver signal of LDI (O3-)	LDI
20	RxO3+	Receiver signal of LDI (O3+)	LDI
21	RxE0-	Receiver signal of LDI (E0-)	LDI
22	RxE0+	Receiver signal of LDI (E0+)	LDI
23	RxE1-	Receiver signal of LVDS (E1-)	LDI
24	RxE1+	Receiver signal of LDI (E1+)	LDI
25	RxE2-	Receiver signal of LDI (E2-)	LDI
26	RxE2+	Receiver signal of LDI (E2+)	LDI
27	RxE3-	Receiver signal of LDI (E3-)	LDI
28	RxE3+	Receiver signal of LDI (E3+)	LDI
29	NC	NC	
30	LVDSGND	LVDSGND	
31	LVDSGND	LVDSGND	

Note1: Resistance (RVR) between GMCL and GMCH enables Gamma adjustment.

(See Fig.4-5-1: RVR=OPEN recommended)

Note2: There is a possibility that trouble occurs in initial and long-term reliability when using it besides corresponding connector.

4-2. Data Mapping

1) 8 bit input

Table 4-2-1 and Fig4-2-2 shows the pin assignment of the input signals.

Table 4-2-1 LDI Input signals

VGA-TFT Data Signal		Input Data Pin (DS90C387)	Output Data Pin (DS90CF386)	LCD Unit Data Signal
LSB	R0	R16	R16	R00
	R1	R17	R17	R01
	R2	R10	R10	R02
	R3	R11	R11	R03
	R4	R12	R12	R04
	R5	R13	R13	R05
	R6	R14	R14	R06
MSB	R7	R15	R15	R07
LSB	G0	G16	G16	G00
	G1	G17	G17	G01
	G2	G10	G10	G02
	G3	G11	G11	G03
	G4	G12	G12	G04
	G5	G13	G13	G05
	G6	G14	G14	G06
MSB	G7	G15	G15	G07
LSB	B0	B16	B16	B00
	B1	B17	B17	B01
	B2	B10	B10	B02
	B3	B11	B11	B03
	B4	B12	B12	B04
	B5	B13	B13	B05
	B6	B14	B14	B06
MSB	B7	B15	B15	B07
LSB		R16	R26	RE0
		R17	R27	RE1
		R10	R20	RE2
		R11	R21	RE3
		R12	R22	RE4
		R13	R23	RE5
		R14	R24	RE6
MSB		R15	R25	RE7
LSB		G16	G26	GE0
		G17	G27	GE1
		G10	G20	GE2
		G11	G21	GE3
		G12	G22	GE4
		G13	G23	GE5
		G14	G24	GE6
MSB		G15	G25	GE7
LSB		B16	B26	BE0
		B17	B27	BE1
		B10	B20	BE2
		B11	B21	BE3
		B12	B22	BE4
		B13	B23	BE5
		B14	B24	BE6
MSB		B15	B25	BE7

LDI Interface block diagram(Single input Dual output)

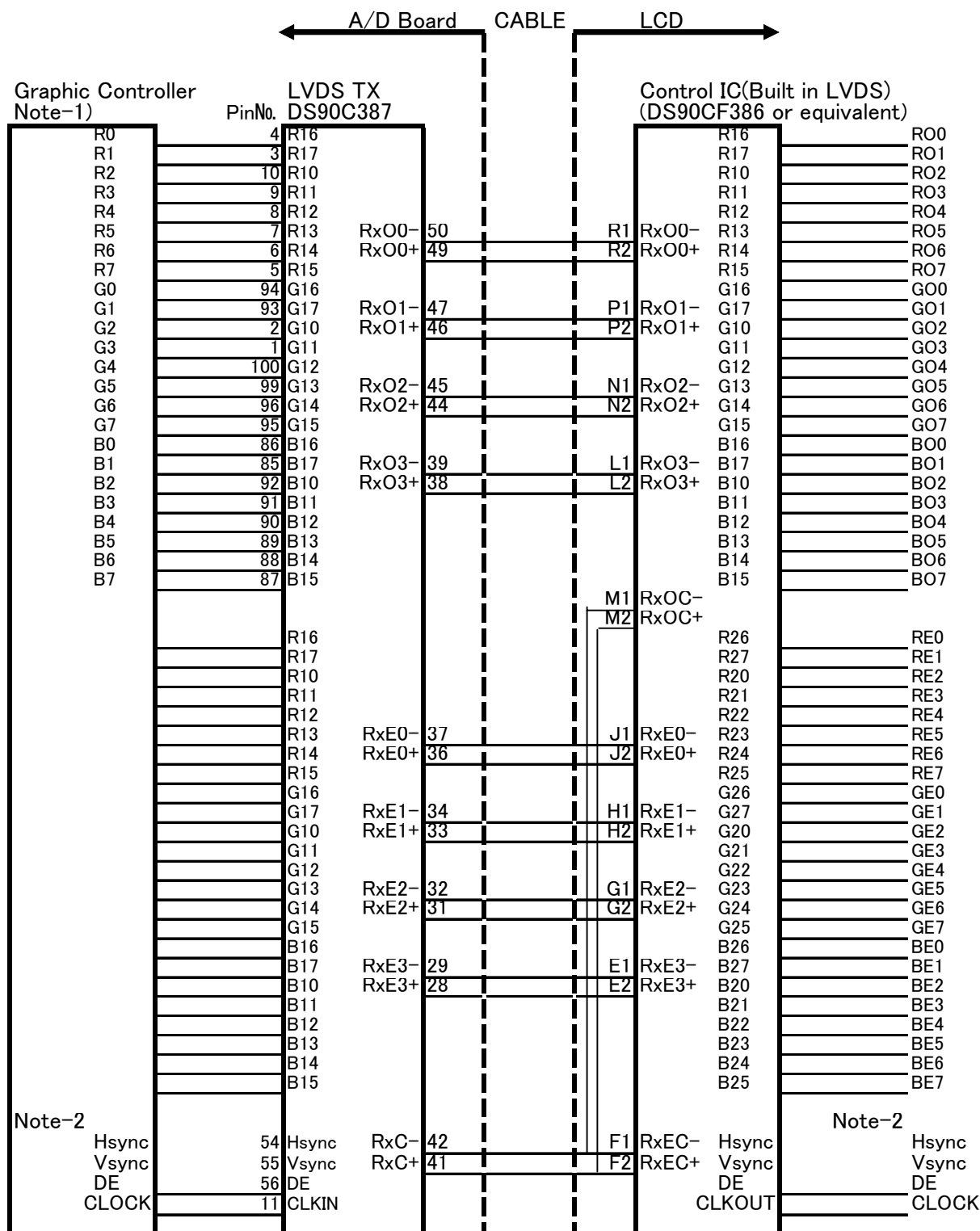
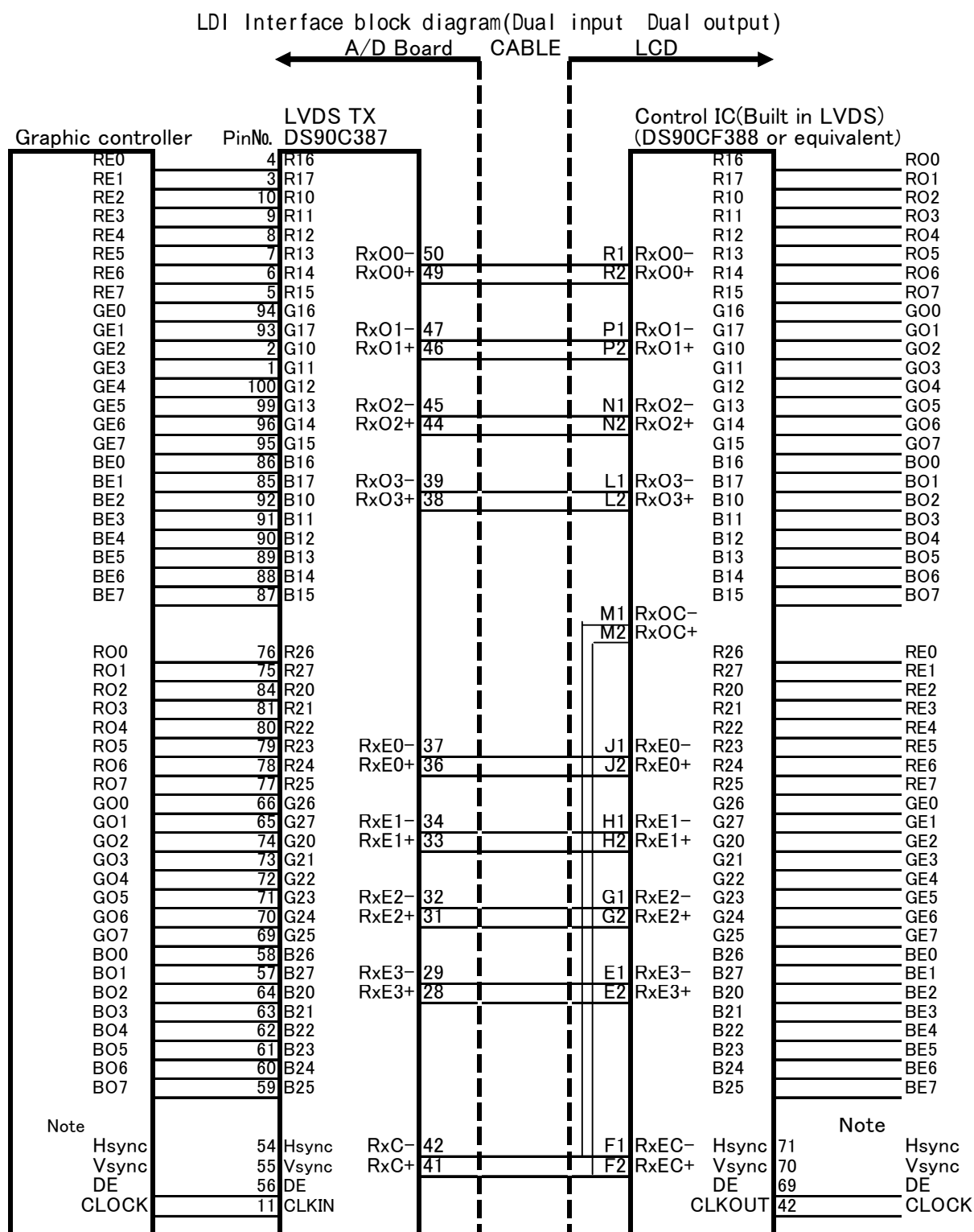

Figure 4-2-2 Interface pin assignment

Table 4-2-3 LDI Input signals(Dual input)

VGA-TFT Data Signal		Input Data Pin (DS90C387)	Output Data Pin (DS90CF386)	LCD Unit Data Signal
LSB	RE0	R16	R16	R00
	RE1	R17	R17	R01
	RE2	R10	R10	R02
	RE3	R11	R11	R03
	RE4	R12	R12	R04
	RE5	R13	R13	R05
	RE6	R14	R14	R06
MSB	RE7	R15	R15	R07
LSB	GE0	G16	G16	G00
	GE1	G17	G17	G01
	GE2	G10	G10	G02
	GE3	G11	G11	G03
	GE4	G12	G12	G04
	GE5	G13	G13	G05
	GE6	G14	G14	G06
MSB	GE7	G15	G15	G07
LSB	BE0	B16	B16	B00
	BE1	B17	B17	B01
	BE2	B10	B10	B02
	BE3	B11	B11	B03
	BE4	B12	B12	B04
	BE5	B13	B13	B05
	BE6	B14	B14	B06
MSB	BE7	B15	B15	B07
LSB	R00	R26	R26	RE0
	R01	R27	R27	RE1
	R02	R20	R20	RE2
	R03	R21	R21	RE3
	R04	R22	R22	RE4
	R05	R23	R23	RE5
	R06	R24	R24	RE6
MSB	R07	R25	R25	RE7
LSB	G00	G26	G26	GE0
	G01	G27	G27	GE1
	G02	G20	G20	GE2
	G03	G21	G21	GE3
	G04	G22	G22	GE4
	G05	G23	G23	GE5
	G06	G24	G24	GE6
MSB	G07	G25	G25	GE7
LSB	B00	B26	B26	BE0
	B01	B27	B27	BE1
	B02	B20	B20	BE2
	B03	B21	B21	BE3
	B04	B22	B22	BE4
	B05	B23	B23	BE5
	B06	B24	B24	BE6
MSB	B07	B25	B25	BE7



Note-1 Hsync, Vsync Not use

Note-2 Use twisted differential cable (impedance = 100)

Note-3. DS90C387: Non-DC Balanced Mode

Figure 4-2-4 Interface pin assignment

4-3. Input signal timing chart

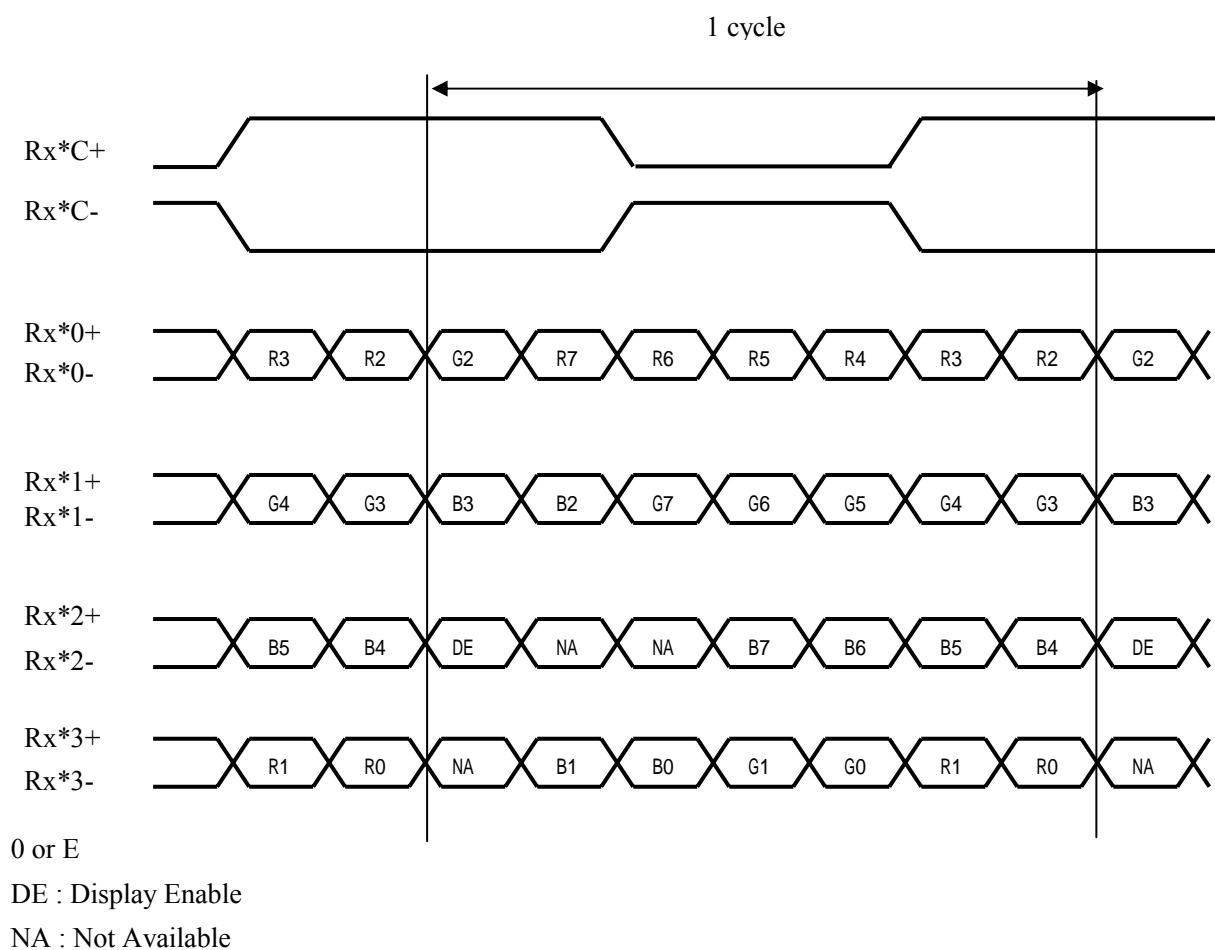

4-4. Backlight

CN2

Using connector : S12B-PH-SM4-TB (JST)

Corresponding connector : PHR-12 (JST) (Cable : AWG#24 recommended)

Pin No.	Symbol	Function	Remark
1	V _{LED}	+12.0V LED Backlight power supply	
2	V _{LED}	+12.0V LED Backlight power supply	
3	V _{LED}	+12.0V LED Backlight power supply	
4	V _{LED}	+12.0V LED Backlight power supply	
5	V _{LED}	+12.0V LED Backlight power supply	
6	LED GND	LED GND	
7	LED GND	LED GND	
8	LED GND	LED GND	
9	LED GND	LED GND	
10	LED GND	LED GND	
11	V _{cnt}	BL ON/OFF	
12	V _{vr}	Brightness control	

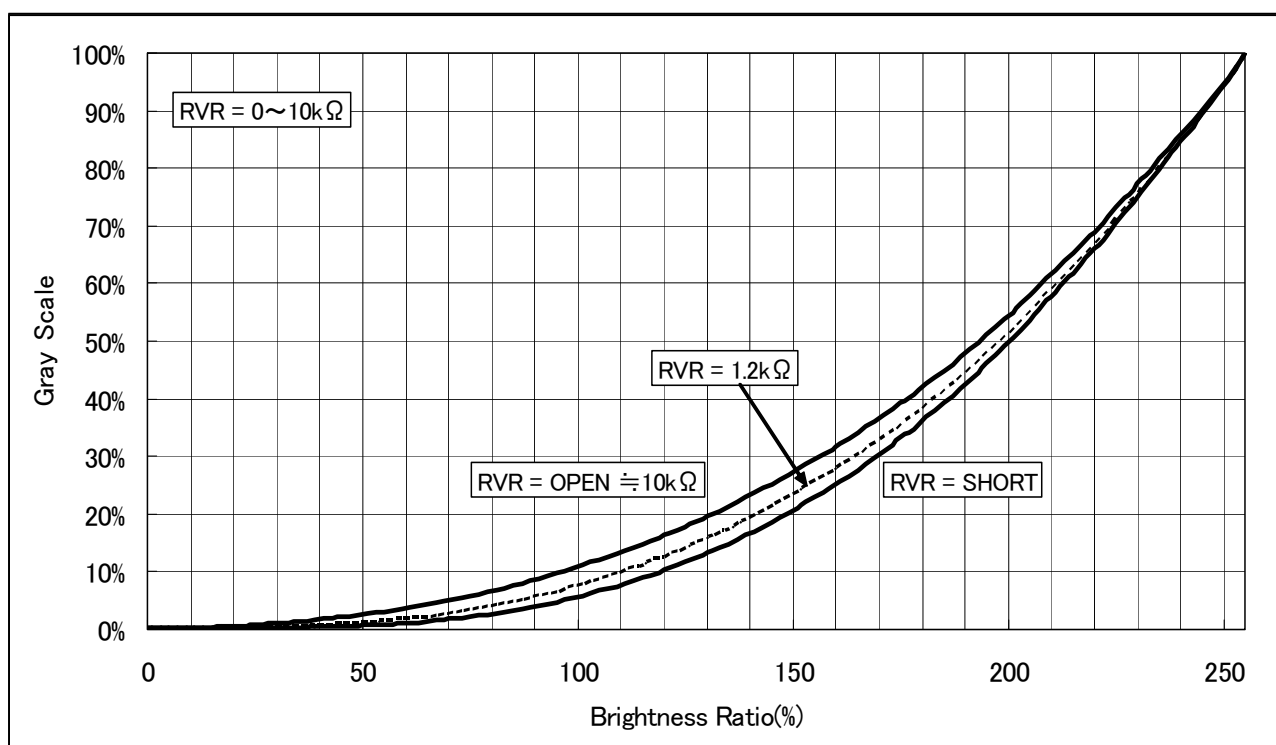

Figure 4-5-1 Gamma characteristics

Note) Fig.4-5-1 shows reference characteristics but dose not guarantee it.

5. Absolute Maximum Ratings

Parameter	Symbol	Condition	Terminal Symbol	Ratings	Unit	Remark
Supply voltage	V _{CC}	T _a =25	V _{CC}	-0.3 ~ +6.0	V	【Note1】
LED Supply voltage	V _{LED}	T _a =25	V _{LED}	-0.3 ~ +14.0		
Input voltage	V _L	T _a =25	LVDS input signal	-0.3 ~ +3.6	V	
	V _{cnt}	T _a =25	V _{cnt}	-0.3 ~ V _{LED}	V	
	V _{vr}	T _a =25	V _{vr}	0 ~ 4.0	V	
LED temperature	T _{LED}	-	-	+90		【Note2】
Storage temperature	T _{STG}	Ambient	-	-20 ~ +65		【Note1】
Operating temperature	T _{OPA}	Ambient	-	min	0	【Note1】
		Panel surface (Active area)	-	max	+60	

【Note1】 Humidity : 90%RH Max. (T_a 40)

Maximum wet-bulb temperature at 39 or less. (T_a>40)

No condensation.

【Note2】 The measurement point refers to Fig. 1.

【Note3】 There is a possibility of causing deterioration in the irregularity and others of the screen and the display fineness when preserving or using it in more than 60 .

【Note4】 When ambient temperature is more than 50 , please cool the back side of the LCD module by a fan.

6. Electrical Characteristics

6-1. TFT-LCD panel driving

Ta = +25

arameter		Symbol	Min.	Typ.	Max.	Unit	Remark
Supply voltage		V _{CC}	+4.75	+5.0	+5.25	V	【Note2】
Current dissipation	V _{CC} =5.0V	I _{CC}	-	1100	1800	mA	【Note3】
Input voltage for LDI	LDI signal	V _L	0	-	2.4	V	
Permissive input ripple voltage		V _{RP}	-	-	100	mVp-p	V _{CC} =+5.0V
Differential input threshold voltage	High	V _{TH}	-	-	V _{CM} +100	mV	V _{CM} =+1.2V
	Low	V _{TL}	V _{CM} -100	-	-	mV	【Note1】
Terminal resistor		R _T	-	100	-		Differential input

【Note1】 V_{CM} : Common mode voltage of LDI driver.

【Note2】 On-off condition for supply voltage

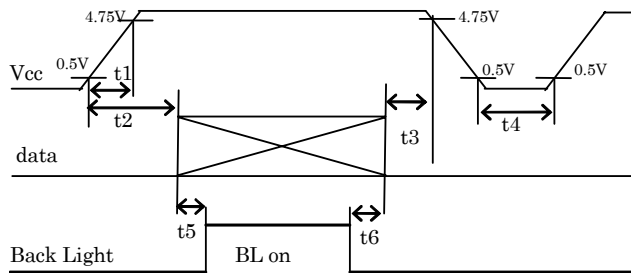

- 0 < t1 20ms 0 < t2 40ms
- 0 < t3 40ms 0.5s t4
- 100ms t5 100ms t6

V_{CC}-dip conditions

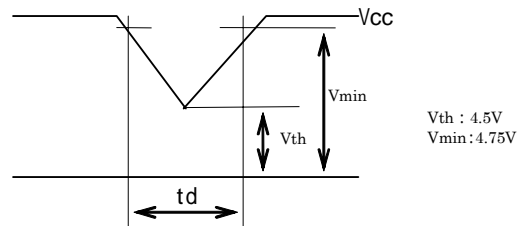

- 1) V_{th} V_{CC} < V_{min}
td 20ms
- 2) V_{CC} < V_{th}

V_{CC}-dip conditions should also follow the on-off conditions for supply voltage.

【Note3】 Current dissipation

Standard value: 16-gray-bar pattern

(Measurement condition V_{CC}=+5.0V, 1/T_c=81MHz, Ta=25)

Refer to Chapter 8 for RGB each gray scale

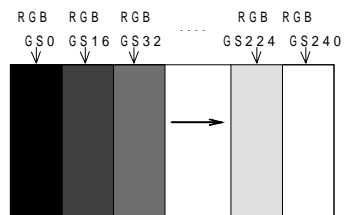

Maximum value: vertical 2dot checker (0/256-255/256)

(Measurement condition V_{CC}=+4.75V, 1/T_c=81MHz, Ta=25)

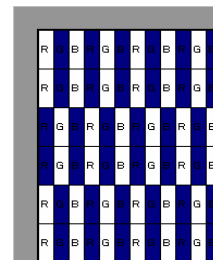

6-2. Backlight

The backlight system is an edge-lighting type with white-LED.

(It is usually required to measure under the following condition.condition: Ta=25 ± 2)

Parameter	Symbol	Min.	Typ.	Max.	Unit	Remark
Supply voltage	V _{LED}	11.4	12.0	12.6	V	
Current dissipation	I _{LED}	-	5.0	5.8	A	V _{LED} = 12.0V V _{VR} = 0V
Brightness Control Voltage	V _{VR}	0	-	3.5	V	【Note1】
LED ON/OFF Low Voltage	V _{cnt} L	0		1.0	V	【Note2】
LED ON/OFF High Voltage	V _{cnt} H	4.5		V _{LED}	V	【Note2】
LED life time	-	30,000	50,000	-	h	LED only

The reference LED life time is 30,000h defined by below.

- (Continuous turning on at LED Junction temperature (Tj) 100°C,
 - LED Current (If) = 150mA (equal to Max.Brightness)
 - A state only for LED)
- When a brightness of LED surface became 50% of the specifications minimum.

- 【Note1】** V_{VR} input :0V= Max.Brightness 3.5V=Min. Brightness
- 【Note2】** V_{cnt} input : Low or OPEN = BL turn on High = BL turn off
- 【Note3】**

On-off condition for supply voltage

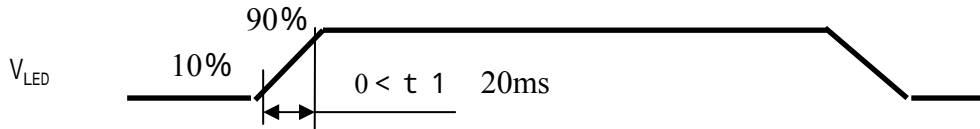

V_{LED}-dip conditions

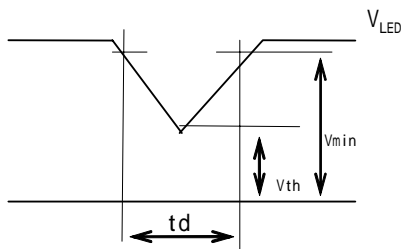

V_{th} : 10.5V
V_{min} : 10.8V

- 1) V_{th} < V_{LED} < V_{min}
t_d 20ms
- 2) V_{LED} < V_{th}

7-2. Input Data Signals and Display Position on the screen

Display position of input data (H, V)

Two pixels data is sampled at the same time.

DO (odd 1 data): RO0 ~ RO7, GO0 ~ GO7, BO0 ~ BO7

DE (even 1 data): RE0 ~ RE7, GE0 ~ GE7, BE0 ~ BE7

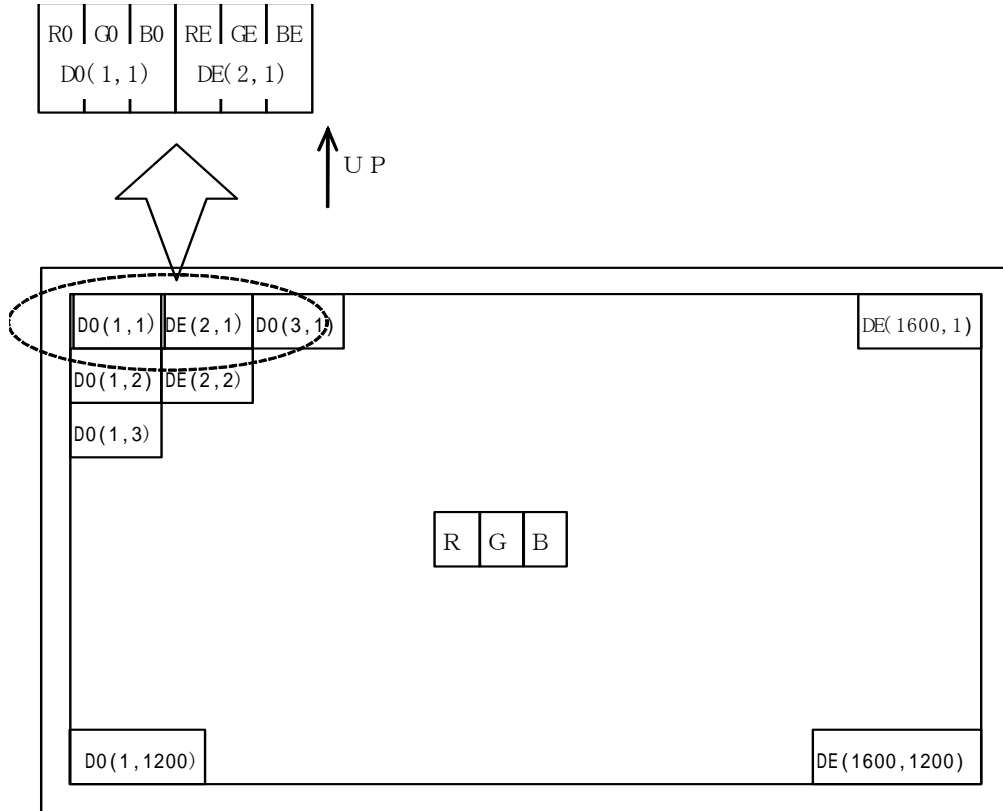

8. Input Signals, Basic Display Colors and Gray Scale of Each Color

8-1. 8bit input

	Colors & Gray scale	Data signal																											
		Gray Scale	R0	R1	R2	R3	R4	R5	R6	R7	G0	G1	G2	G3	G4	G5	G6	G7	B0	B1	B2	B3	B4	B5	B6	B7			
Basic Color	Black	-	0	0	0	0	0	0	0	0	0	0	0	0	0	0	0	0	0	0	0	0	0	0	0	0	0		
	Blue	-	0	0	0	0	0	0	0	0	0	0	0	0	0	0	0	0	1	1	1	1	1	1	1	1	1		
	Green	-	0	0	0	0	0	0	0	0	1	1	1	1	1	1	1	1	0	0	0	0	0	0	0	0	0		
	Cyan	-	0	0	0	0	0	0	0	0	1	1	1	1	1	1	1	1	1	1	1	1	1	1	1	1	1		
	Red	-	1	1	1	1	1	1	1	1	0	0	0	0	0	0	0	0	0	0	0	0	0	0	0	0	0		
	Magenta	-	1	1	1	1	1	1	1	1	0	0	0	0	0	0	0	0	1	1	1	1	1	1	1	1	1		
	Yellow	-	1	1	1	1	1	1	1	1	1	1	1	1	1	1	1	1	0	0	0	0	0	0	0	0	0		
	White	-	1	1	1	1	1	1	1	1	1	1	1	1	1	1	1	1	1	1	1	1	1	1	1	1	1		
Gray Scale of Red	Black	0	0	0	0	0	0	0	0	0	0	0	0	0	0	0	0	0	0	0	0	0	0	0	0	0	0		
	↑	1	1	0	0	0	0	0	0	0	0	0	0	0	0	0	0	0	0	0	0	0	0	0	0	0	0		
	Darker	2	0	1	0	0	0	0	0	0	0	0	0	0	0	0	0	0	0	0	0	0	0	0	0	0	0		
	↑	↓								↓							↓												
	↓	↓								↓							↓												
	Brighter	253	1	0	1	1	1	1	1	1	0	0	0	0	0	0	0	0	0	0	0	0	0	0	0	0	0		
	↓	254	0	1	1	1	1	1	1	1	0	0	0	0	0	0	0	0	0	0	0	0	0	0	0	0	0		
	Red	255	1	1	1	1	1	1	1	1	0	0	0	0	0	0	0	0	0	0	0	0	0	0	0	0	0		
Gray Scale of Green	Black	0	0	0	0	0	0	0	0	0	0	0	0	0	0	0	0	0	0	0	0	0	0	0	0	0	0		
	↑	1	0	0	0	0	0	0	0	0	1	0	0	0	0	0	0	0	0	0	0	0	0	0	0	0	0		
	Darker	2	0	0	0	0	0	0	0	0	0	1	0	0	0	0	0	0	0	0	0	0	0	0	0	0	0		
	↑	↓								↓							↓												
	↓	↓								↓							↓												
	Brighter	253	0	0	0	0	0	0	0	0	1	0	1	1	1	1	1	1	0	0	0	0	0	0	0	0	0		
	↓	254	0	0	0	0	0	0	0	0	0	1	1	1	1	1	1	1	0	0	0	0	0	0	0	0	0		
	Green	255	0	0	0	0	0	0	0	0	1	1	1	1	1	1	1	1	0	0	0	0	0	0	0	0	0		
Gray Scale of Blue	Black	0	0	0	0	0	0	0	0	0	0	0	0	0	0	0	0	0	0	0	0	0	0	0	0	0	0		
	↑	1	0	0	0	0	0	0	0	0	0	0	0	0	0	0	0	0	1	0	0	0	0	0	0	0	0		
	Darker	2	0	0	0	0	0	0	0	0	0	0	0	0	0	0	0	0	0	1	0	0	0	0	0	0	0		
	↑	↓								↓							↓												
	↓	↓								↓							↓												
	Brighter	253	0	0	0	0	0	0	0	0	0	0	0	0	0	0	0	0	1	0	1	1	1	1	1	1	1		
	↓	254	0	0	0	0	0	0	0	0	0	0	0	0	0	0	0	0	0	1	1	1	1	1	1	1	1		
	Blue	255	0	0	0	0	0	0	0	0	0	0	0	0	0	0	0	0	1	1	1	1	1	1	1	1	1		

0 : Low level voltage, 1 : High level voltage.

Each basic color can be displayed in 256 gray scales of red, 256 gray scales of green, and 256 gray scales of blue from 8 bit data signals. According to the combination of total 24 bit data signals, 16,777,216 color display can be achieved on the screen.

9. Optical Characteristics

Ta=25 , Vcc =+5.0V

Parameter		Symbol	Condition	Min.	Typ.	Max.	Unit	Remark
Viewing angle range	Horizontal	21, 22	CR > 10	85	-	-	Deg.	
	Vertical	11, 12		85	-	-	Deg.	
	All direction			-	80	-	Deg.	
Contrast ratio		CRn	Optimum viewing angle	350	600	-		【Note2,4】
Response Time (Black White Black)		r+ d	=0 °	-	12	-	ms	【Note3(Condition2),4,5】
Response Time Rise or decay (Gray scale)		avg		-	8	-	ms	Average response time
Chromaticity of White		x y		0.257 0.290	0.292 0.315	0.337 0.370		【Note4】
Chromaticity of Red		x y	- -	0.629 0.362	- -			
Chromaticity of Green		x y	- -	0.322 0.610	- -			
Chromaticity of Blue		x y	- -	0.149 0.108	- -			
Luminance of white		Y _{LI}	400	500	-	cd/m ²	【Note4】	
White Uniformity		w	-	-	1.33		【Note5】	

The measurement shall be executed 30 minutes after lighting at rating.

The optical characteristics shall be measured in a dark room or equivalent state with the method shown in Fig.9 below.

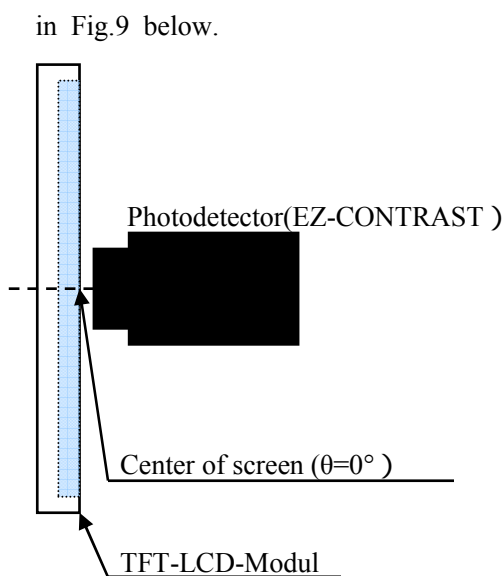

Fig9-1 Viewing angle measurement method

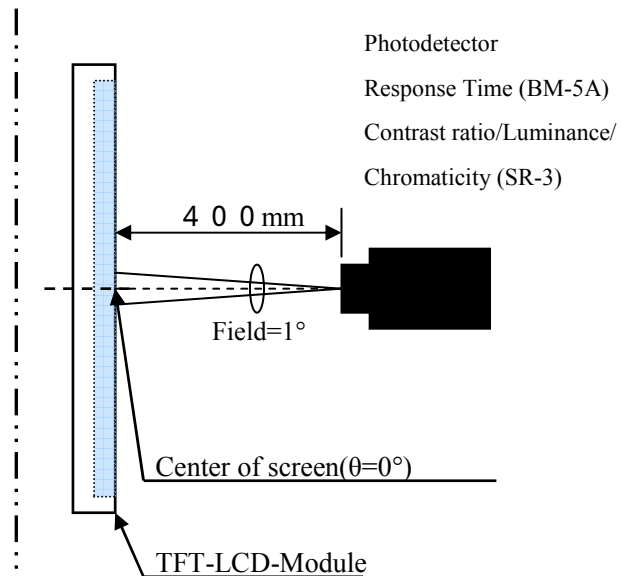
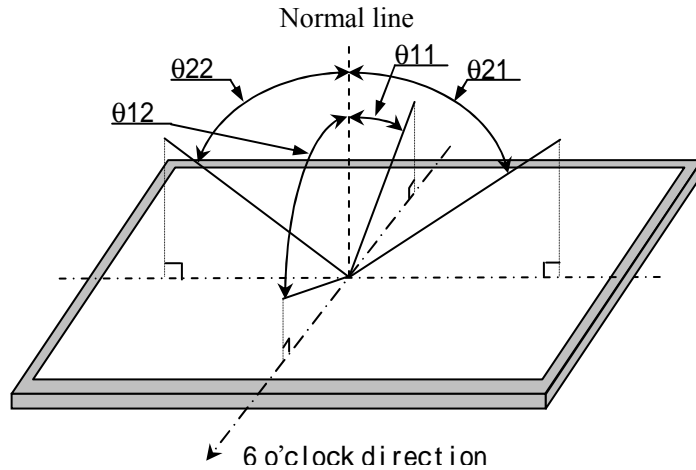

Fig9-2 Luminance/Contrast ratio/Response time/Chromaticity measurement method

Fig9 Optical characteristics measurement method

measurement method

【Note1】 Definitions of viewing angle range:



【Note2】 Definition of contrast ratio:

The contrast ratio is defined as the following.

$$\text{Contrast Ratio (CR)} = \frac{\text{Luminance (brightness) with all pixels white}}{\text{Luminance (brightness) with all pixels black}}$$

【Note3】 Definition of response time:

The response time is defined as the following figure and shall be measured by switching the input signal for "black" and "white".

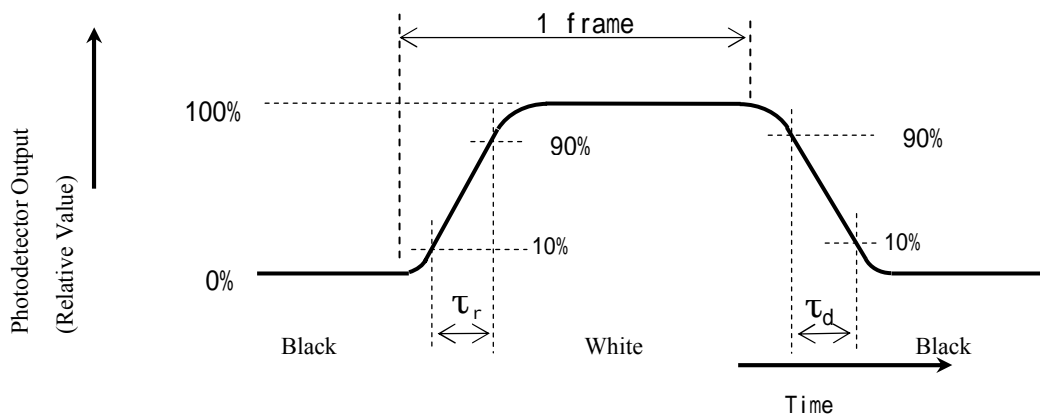

【Note4】 This shall be measured at center of the screen.

【Note5】 Definition of white uniformity:

White uniformity is defined as the following with nine measurements (①~⑨).

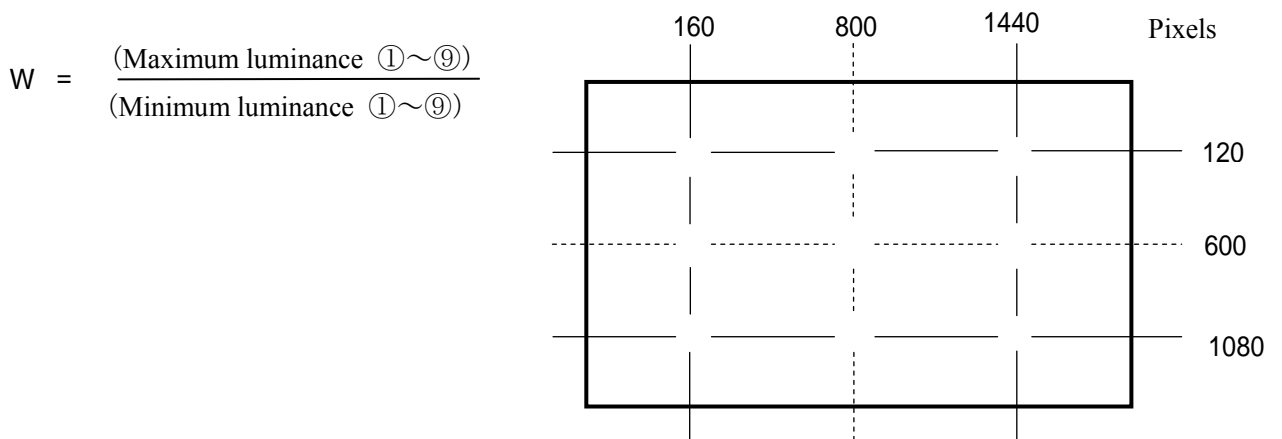

10. Display dignity

The item concerning externals and the display dignity is decided by the shipment inspection standard book..

11. Handling Precautions

- a) Be sure to turn off the power supply when inserting or disconnecting the cable.
- b) Be sure to design the cabinet so that the module can be installed without any extra stress such as warp or twist.
- c) Since the front polarizer is easily damaged, pay attention not to scratch it.
Blow away dust on the polarizer with antistatic N₂ blow. It is undesirable to wipe off because a polarizer is sensitive.
It is recommended to peel off softly using the adhesive tape when soil or finger oil is stuck to the polarizer.
When unavoidable, wipe off carefully with a cloth for wiping lenses.
- d) Wipe off water drop immediately. Long contact with water may cause discoloration or spots.
- e) When the panel surface is soiled, wipe it with absorbent cotton or other soft cloth.
- f) Since the panel is made of glass, it may break or crack if dropped or bumped on hard surface.
Handle with care.
- g) Since CMOS LSI is used in this module, take care of static electricity and set the human earth when handling. Observe all other precautionary requirements in handling components.
- h) Since there is a circuit board in the module back, stress is not added at the time of a design assembly.
If stress is added, there is a possibility that circuit parts may be damaged.
- i) Protection film is attached to the module surface to prevent it from being scratched .
Peel the film off slowly, just before the use, with strict attention to electrostatic charges.
Blow off 'dust' on the polarizer by using ionized nitrogen.
- j) The polarizer surface on the panel is treated with Anti-Glare for low reflection. In case of attaching protective board over the LCD, be careful about the optical interface fringe etc. which degrades display quality.
- k) Do not expose the LCD panel to direct sunlight.
Lightproof shade etc. should be attached when LCD panel is used under such environment.
If a light strong against a LCD panel is irradiated, it may lead to degradation of the panel characteristic and display grace may get worse.
- l) Connect GND to 4 place of mounting holes to stabilize against EMI and external noise.
- m) When handling LCD modules and assembling them into cabinets, please be noted that long-term storage in the environment of oxidization or deoxidization gas, and the use of such materials as reagent, solvent, adhesive, resin, etc. which generate these gasses, may cause corrosion, discoloration, degradation of display grace, and abnormalities of operation.
- n) When install LCD modules in the cabinet, please tighten with “torque = max 0.441 N·m (max 4.5kgf·cm).
Be sure to confirm it in the same condition as it is installed in your instrument.
- o) Liquid crystal contained in the panel may leak if the LCD is broken. Rinse it as soon as possible if it gets inside your eye or mouth by mistake.
- p) Notice : Never dismantle the module , because it will cause failure.
Moreover, please do not peel off and do not cut the tapes pasted to the product.
However, the tape fixed panel protection film is excluded.
- q) Be careful when using it for long time with fixed pattern display as it may cause afterimage.
(Please use a screen saver etc., in order to avoid an afterimage.)
- r) Adjusting volume has been set optimally before shipment, so do not change any adjusted value.
If adjusted value is changed, the specification may not be satisfied.
- s) If a minute particle enters in the module and adheres to an optical material, it may cause display non-uniformity issue, etc. Therefore, fine-pitch filters have to be installed to cooling and inhalation hole if you intend to install a fan.
- t) The LED used for this product is very sensitive to the temperature. Luminance decreases rapidly when it is used for a long time under the environment of the high temperature. Please consult our company when it is used under the environment like the above mentioned.
- u) Epoxy resin (amine series curing agent), silicone adhesive material (dealcoholization series and oxime series), tray forming agent (azo compound) etc, in the cabinet or the packing materials may induce abnormal display with polarizer film deterioration regardless of contact or noncontact to polarizer film.
Be sure to confirm the component of them.

12. Packing form

Product countries / Areas	JAPAN
Piling number of cartons	8 (MAX)
Packing quantity in one carton	2pcs
Carton size [mm]	630(W) × 515(D) × 195(H)
Total mass of one carton filled with full modules	11kg
Packing form is shown	Page 22 (Fig.2)

13 . Reliability test items

No	Test item	Conditions	
1	High temperature storage test	Ta = 65 240h	
2	Low temperature storage test	Ta = -20 240h	
3	High temperature & high humidity operation test	Ta = 40 ; 90%RH 240h (No condensation)	
4	High temperature operation test	Ta = 60 240h (Panel surface:Activ Area)	
5	Low temperature operation test	Ta = 0 240h	
6	Vibration test	Waveform : Sine wave Frequency : 10 ~ 57Hz/Vibration width (one side) : 0.076mm : 57 ~ 500Hz/Gravity : 9.8m/s ² Sweep time : 11minutes Test period : 3 hours (1 hour for each direction of X,Y,Z)	【Note】
7	Shock test	Max. gravity : 147m/s ² Pulse width : 6ms, sine half-wave Direction : ± X, ± Y, ± Z, once for each direction.	

【Note】

A gap of panel shall not occur by vibration or the shock.

【Result Evaluation Criteria】

Under the display quality test conditions with normal operation state, these shall be no change which may affect practical display function.

14. Others

14-1. Lot No. Label

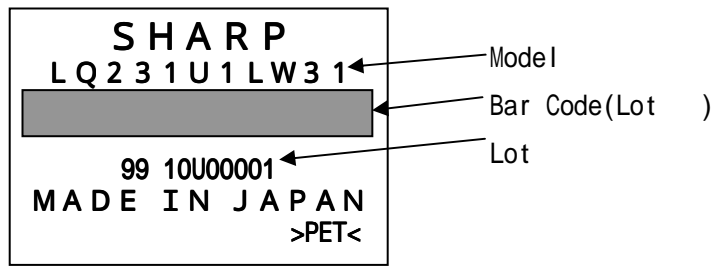
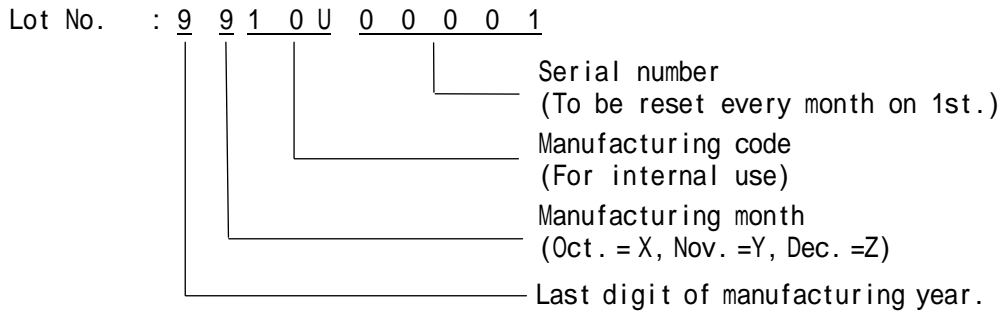

14-2. Packing box Label

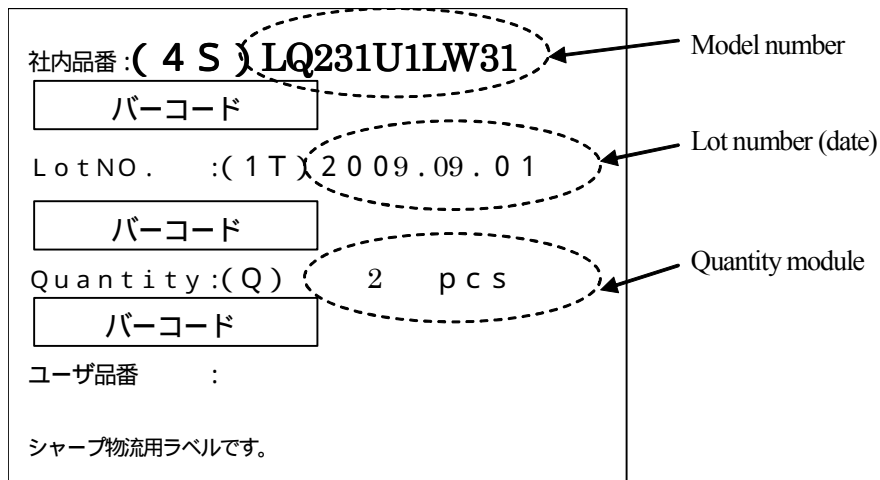

14-3. The chemical ozone depleting substance is not used.

14-4. If any problem occurs in relation to the description of this specification, it shall be resolved through discussion with spirit of cooperation.

The figure left below (cardboard box recycling symbol mark) is written to the packing box.

And, the figure right below is written to the packing box of the settlement for the RoHS restriction.

R.C. (RoHS Compliance) means it suits the RoHS directive.

This LCD module is compliant with RoHS Directive.



Cardboard box ・
Recycling symbol mark



Mark for RoHS directive

15 . Range of storage temperature and humidity environmental condition

Temperature 0 ~ 40

Relative humidity 90% and below

(Note) • Please manage as average value of the storage temperature and humidity environment referring to the following condition.

Summer 20 ~ 35 85% and below, Winter 5 ~ 15 85% and below

- Please manage within 240 hours in total at the time kept under the environment of 40 90%RH.

Direct sunlight

Please keep it in the state of wrapping or the darkroom so that direct sunshine should not strike directly into the product.

Ambient atmosphere

Please do not keep it in the place with the danger of the generation of the causticity gas and the volatile solvent.

Dewy condensation prevention

- Please do not put the wrapping box directly on the floor, and keep it on palette or rack to avoid dewy condensation.

Moreover, please put it in a constant direction correctly to improve ventilation under the palette.

- Please separate from the wall in the storage warehouse and keep it.
- Please pay attention that ventilation is improved, and set up the ventilator etc. in the warehouse.
- Please manage so that there is no rapid temperature change more than natural environment.

Storage period

Please keep within one year under the above-mentioned storage condition.

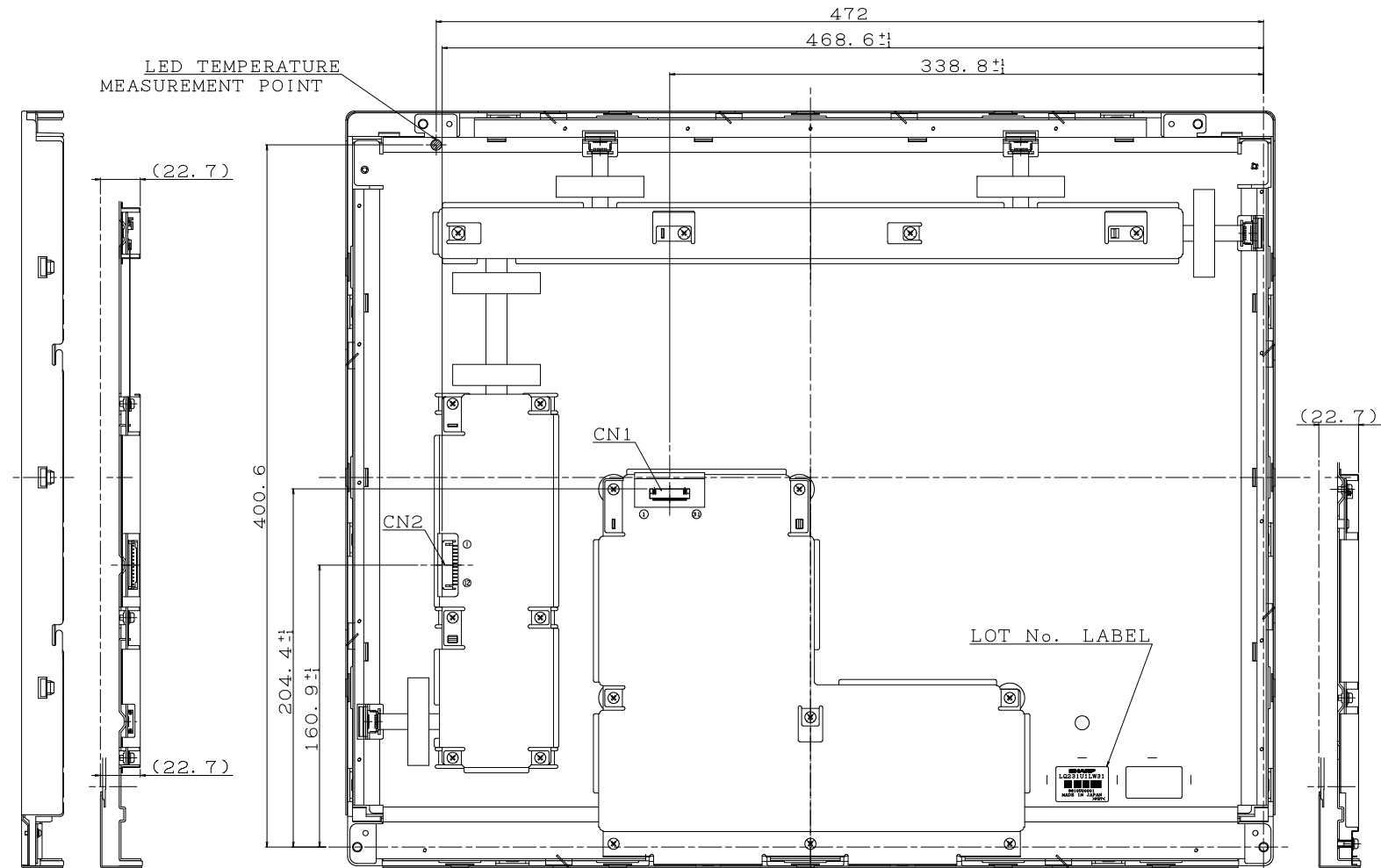
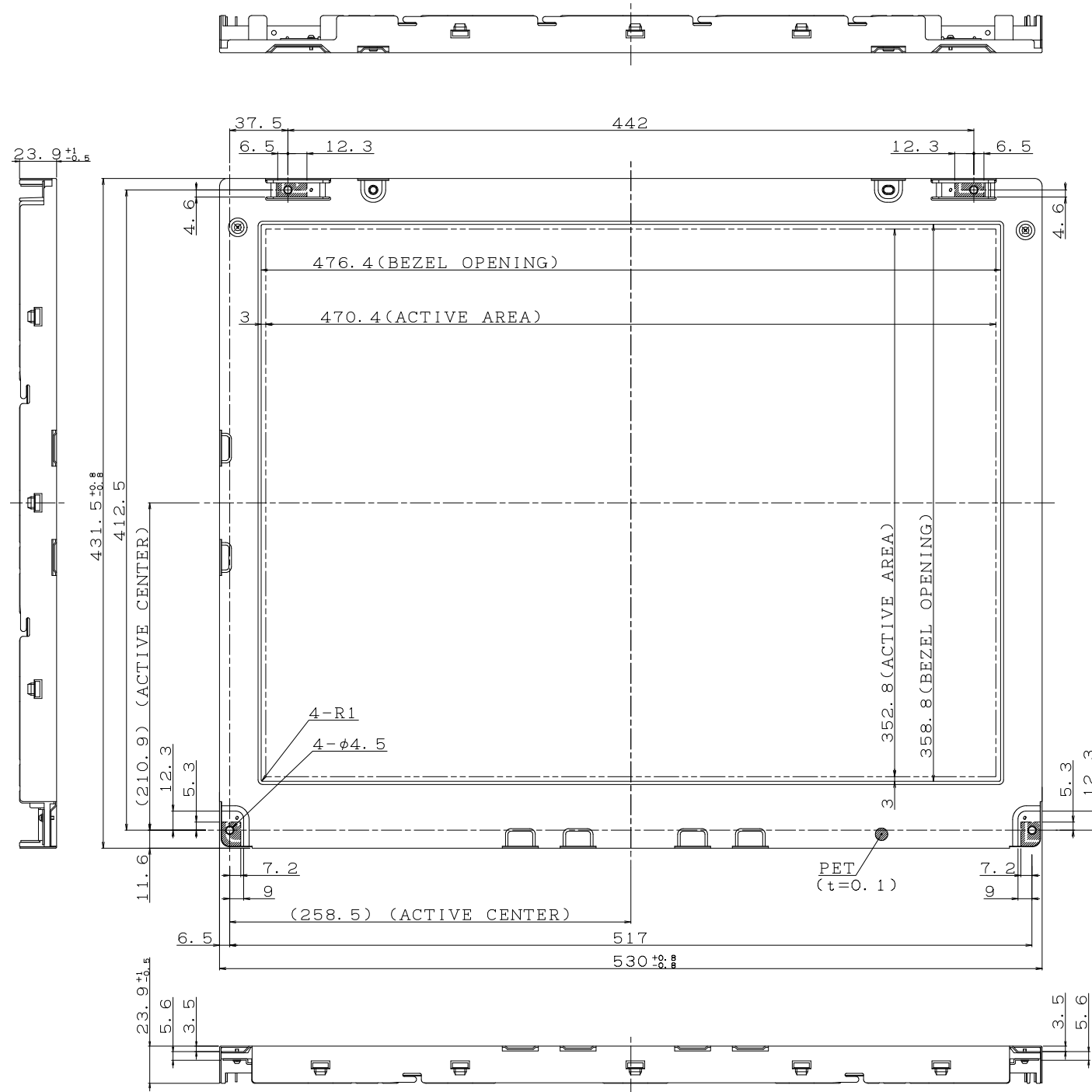

CN1: Japan Aviation Electronics Industry, Limited
MODEL No. FI-WE31P-HFE

1 Vcc	9 GMCH	17 RxO-	25 RxE2-
2 Vcc	10 GMCL	18 RxO+	26 RxE2+
3 Vcc	11 RxO0-	19 RxO3-	27 RxE3-
4 Vcc	12 RxO0+	20 RxO3+	28 RxE3+
5 GND	13 RxO1-	21 RxEO-	29 NC
6 GND	14 RxO1+	22 RxEO+	30 LVDSGND
7 GND	15 RxO2-	23 RxE1-	31 LVDSGND
8 NC	16 RxO2+	24 RxE1+	

CN1 PIN ASSIGN

CN2: Japan Solderless Terminal Mfg Co Ltd(JST)
MODEL No. S12B-PH-SM4-TB

1 VLED	7 LED GND
2 VLED	8 LED GND
3 VLED	9 LED GND
4 VLED	10 LED GND
5 VLED	11 Vcnt
6 LED GND	12 Vvr

CN2 PIN ASSIGN

BEZEL/DISPLAY POSITION

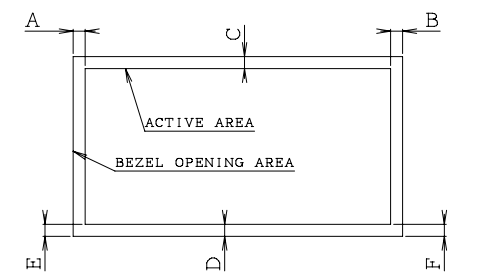

- 1) TOLERANCE X-DIRECTION A: 3.0 ± 0.8
- 2) TOLERANCE Y-DIRECTION B: 3.0 ± 0.8
- 3) TOLERANCE Y-DIRECTION C: 3.0 ± 0.8
- 4) TOLERANCE Y-DIRECTION D: 3.0 ± 0.8
- 5) OBLIQUITY OF DISPLAY AREA |E-F| < 0.8

UNSPECIFIED TOLERANCE TO BE ±1.0
UNIT: mm

Fig 1: LQ231U1LW31 Outline dimensions

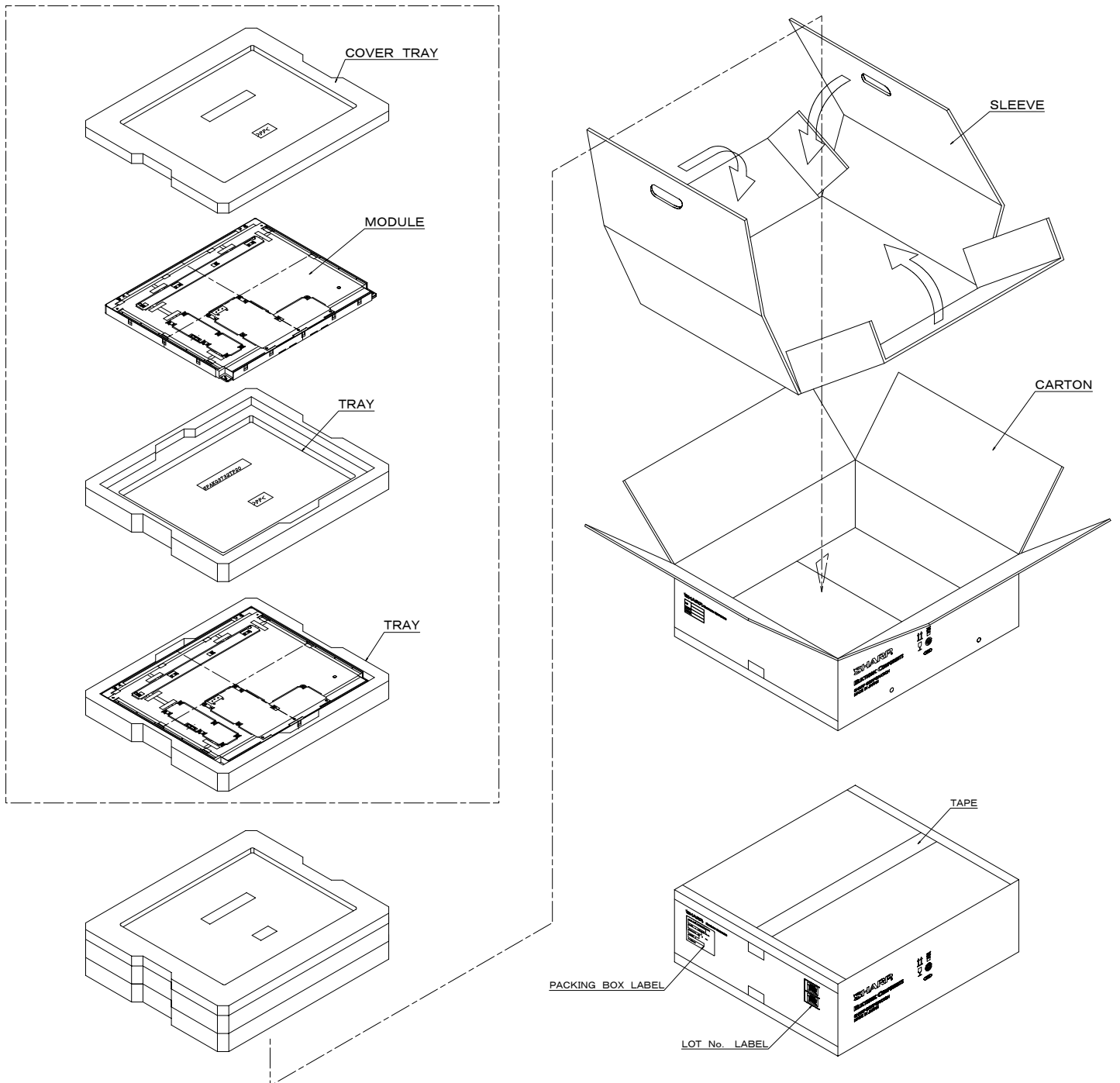

Fig2:Packing Form

LCD Specification

LCD Group



NORTH AMERICA

Sharp Microelectronics of the Americas
5700 NW Pacific Rim Blvd.
Camas, WA 98607, U.S.A.
Phone: (1) 360-834-8700
Fax: (1) 360-834-8903
www.sharpsma.com

TAIWAN

Sharp Electronic Components
(Taiwan) Corporation
8F-A, No. 16, Sec. 4, Nanking E. Rd.
Taipei, Taiwan, Republic of China
Phone: (886) 2-2577-7341
Fax: (886) 2-2577-7326/2-2577-7328

CHINA

Sharp Microelectronics of China
(Shanghai) Co., Ltd.
28 Xin Jin Qiao Road King Tower 16F
Pudong Shanghai, 201206 P.R. China
Phone: (86) 21-5854-7710/21-5834-6056
Fax: (86) 21-5854-4340/21-5834-6057
Head Office:
No. 360, Bashen Road,
Xin Development Bldg. 22
Waigaoqiao Free Trade Zone Shanghai
200131 P.R. China
Email: smc@china.global.sharp.co.jp

EUROPE

Sharp Microelectronics Europe
Division of Sharp Electronics (Europe) GmbH
Sonninstrasse 3
20097 Hamburg, Germany
Phone: 49 (0)180 507 35 07
Fax: (49) 40-2376-2232
www.sharpsme.com

SINGAPORE

Sharp Electronics (Singapore) PTE., Ltd.
438A, Alexandra Road, #05-01/02
Alexandra Technopark,
Singapore 119967
Phone: (65) 271-3566
Fax: (65) 271-3855

KOREA

Sharp Electronic Components
(Korea) Corporation
RM 501 Geosung B/D, 541
Dohwa-dong, Mapo-ku
Seoul 121-701, Korea
Phone: (82) 2-711-5813 ~ 8
Fax: (82) 2-711-5819

JAPAN

Sharp Corporation
Electronic Components & Devices
22-22 Nagaïke-cho, Abeno-Ku
Osaka 545-8522, Japan
Phone: (81) 6-6621-1221
Fax: (81) 6117-725300/6117-725301
www.sharp-world.com

HONG KONG

Sharp-Roxy (Hong Kong) Ltd.
Level 26, Tower 1, Kowloon Commerce Centre,
No. 51, Kwai Cheong Road, Kwai Chung,
New Territories, Hong Kong
Phone: (852) 28229311
Fax: (852) 28660779
www.sharp.com.hk
Shenzhen Representative Office:
Room 602-603, 6/F,
International Chamber of Commerce Tower,
168 Fuhua Rd. 3, CBD,
Futian District, Shenzhen 518048,
Guangdong, P.R. China
Phone: (86) 755-88313505
Fax: (86) 755-88313515

SPECIFICATIONS ARE SUBJECT TO CHANGE WITHOUT NOTICE.

Suggested applications (if any) are for standard use; See Important Restrictions for limitations on special applications. See Limited Warranty for SHARP's product warranty.

The Limited Warranty is in lieu, and exclusive of, all other warranties, express or implied.

ALL EXPRESS AND IMPLIED WARRANTIES, INCLUDING THE WARRANTIES OF MERCHANTABILITY, FITNESS FOR USE AND FITNESS FOR A PARTICULAR PURPOSE, ARE SPECIFICALLY EXCLUDED. In no event will SHARP be liable, or responsible in any way, for any incidental or consequential economic or property damage.