

LUXEON 3030 2D

Hot color targeted 6V QFN package delivering high flux

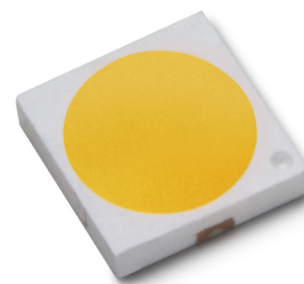

Introduction

The LUXEON 3030 2D mid-power LED is the first hot color targeted mid power LED. The LUXEON 3030 2D uses industry standard packaging and is a 6V surface-mount emitter solution that comes in all ANSI CCTs. Hot color targeting ensures that the LEDs are within color target at 85°C application conditions.

Features

- Industry standard package
- NEW 1/9th micro color binning
- Hot color targeted
- Leading efficacy of 125 lm/W for warm white and 133 lm/W for cool white at 120 mA and 25°C

Benefits

- Drop-in replacement for existing 3030 LED packages
- Hot color targeting ensures that color is within ANSI bin at typical application conditions
- Reduced LED count
- Enables 3, 4, 5-step MacAdam Ellipse kits

Key Applications

- Downlights
- High bay and low bay
- Lamps

Table of Contents

| | |
|---|----|
| General Information | 2 |
| Product Nomenclature | 2 |
| Average Lumen Maintenance Characteristics | 2 |
| Environmental Compliance | 2 |
| Product Selection | 3 |
| Electrical Characteristics | 3 |
| Absolute Maximum Ratings | 4 |
| JEDEC Moisture Sensitivity | 4 |
| Reflow Soldering Characteristics | 5 |
| Mechanical Dimensions and Package Information | 6 |
| Mechanical Dimensions | 6 |
| Recommended Soldering Pad Pattern and Metal Solder Stencil Aperture | 7 |
| Package Dimensions of Tape (Unit: mm) | 7 |
| Package Dimensions of Reel | 8 |
| Package Labeling | 8 |
| Moisture Proof Package | 9 |
| Relative Spectral Distribution | 10 |
| Typical Radiation Patterns | 12 |
| Product Binning and Labeling | 13 |
| Luminous Flux Bins | 13 |
| Forward Voltage Bins | 14 |
| Color Bin Structure | 15 |

General Information

Product Nomenclature

LUXEON 3030 2D is tested and binned at $T_j = 25^\circ\text{C}$ with a drive current of 120 mA DC.

The part number designation is explained as follows:

L 13 0 - A A B B 0 0 C C 0 0 W 2 1

Where:

AA — designates CCT (for example, 2700K = 27)

BB — designates CRI (70, 80 and 90)

CC — designates last 2 digits of 3030 package

For example, a LUXEON 3030 2D 2700K 80CRI emitter has the following part number.

L 13 0 - 2 7 8 0 0 0 3 0 0 0 W 2 1

Average Lumen Maintenance Characteristics

The LUXEON 3030 2D is being tested in accordance with LM-80 standards. Please contact your Philips Lumileds' TSM or Sales person for more detailed information.

Environmental Compliance

Philips Lumileds is committed to providing environmentally friendly products to the solid-state lighting market. LUXEON 3030 2D is compliant to the European Union directives on the restriction of hazardous substances in electronic equipment, namely the RoHS and REACH directives. Philips Lumileds will not intentionally add the following restricted material to the LUXEON 3030 2D L130-****003000W21: lead, mercury, cadmium, hexavalent chromium, polybrominated biphenyls (PBB) or polybrominated diphenyl ethers (PBDE).

Product Selection

Product Selection Guide for LUXEON 3030 2D Junction Temperature = 25°C

Table 1.

| Nominal CCT | Part Number | Minimum CRI ^[1] | Luminous Flux (lm) ^[1] @ 120 mA | | Luminous Flux (lm) ^[2] @ 100 mA | R _{th,J-c} (°C/W) ^[3] |
|-------------|--------------------|----------------------------|--|---------|--|---|
| | | | Minimum | Typical | Typical | Typical |
| 2700K | L130-2780003000W21 | 80 | 77 | 84 | 71 | |
| 3000K | L130-3080003000W21 | 80 | 85 | 90 | 75 | |
| 3500K | L130-3580003000W21 | 80 | 82 | 93 | 79 | |
| 4000K | L130-4080003000W21 | 80 | 84 | 95 | 81 | 12 |
| 5000K | L130-5080003000W21 | 80 | 86 | 96 | 81 | |
| 5700K | L130-5780003000W21 | 80 | 87 | 97 | 82 | |
| 6500K | L130-6580003000W21 | 80 | 87 | 97 | 82 | |

Notes for Table 1:

- Philips Lumileds maintains a tolerance of ± 7.5% on luminous flux, ± 2 on CRI.
- Interpolated value.
- Thermal resistance is measured junction to case.

Electrical Characteristics

Junction Temperature = 25°C, Test Current @ 120 mA

Table 2.

| Part Number | Forward Voltage V _f ^{[1][3]} (V) | | | Typical Temperature Coefficient of Forward Voltage Between 25°C and 85°C ^[2] $\Delta V_F / \Delta T_J$ |
|--------------------|--|---------|---------|--|
| | Minimum | Typical | Maximum | |
| L130-2780003000W21 | | | | |
| L130-3080003000W21 | | | | |
| L130-3580003000W21 | | | | |
| L130-4080003000W21 | 5.8 | 6.1 | 6.6 | -2.0 to -4.0 |
| L130-5080003000W21 | | | | |
| L130-5780003000W21 | | | | |
| L130-6580003000W21 | | | | |

Notes for Table 2:

- Philips Lumileds maintains a tolerance of ± 0.1V on forward voltage measurements.
- Measured between T_J = 25°C and T_J = 85°C.
- Forward voltage test tolerance: ± 0.1 volts.

Absolute Maximum Ratings

No parameter can surpass its maximum rating under any condition. Care must be maintained to insure junction and case temperatures are properly derated with current.

Table 3.

| Parameter | Maximum Performance |
|----------------------------------|--|
| DC Forward Current | 240 mA |
| Peak Pulsed Forward Current | 300 mA ^[1] |
| ESD Sensitivity | < 1000V Human Body Model (HBM) Class 2A JS-001-2012 |
| Maximum Case Temperature | 100°C |
| Soldering Temperature | JEDEC 020D 260°C |
| Storage Temperature | -40°C - 100°C |
| LED Junction Temperature | 125°C |
| Allowable Reflow Cycles | 3 |
| Reverse Voltage ^[2,3] | -5V |

Notes for Table 3:

1. At 10% duty cycle and pulse width 10ms.
2. LUXEON 3030 2D are not designed to be driven in reverse bias.
3. At a maximum reverse current of 10 mA.

JEDEC Moisture Sensitivity

Table 4.

| Level | Floor Life | | Soak Requirements | |
|-------|------------|-----------------|------------------------|-----------------|
| | | | Standard | |
| | Time | Conditions | Time | Conditions |
| 2 | 1 year | ≤ 30°C / 60% RH | 168 Hrs. + 5 / -0 Hrs. | ≤ 85°C / 60% RH |

Reflow Soldering Characteristics

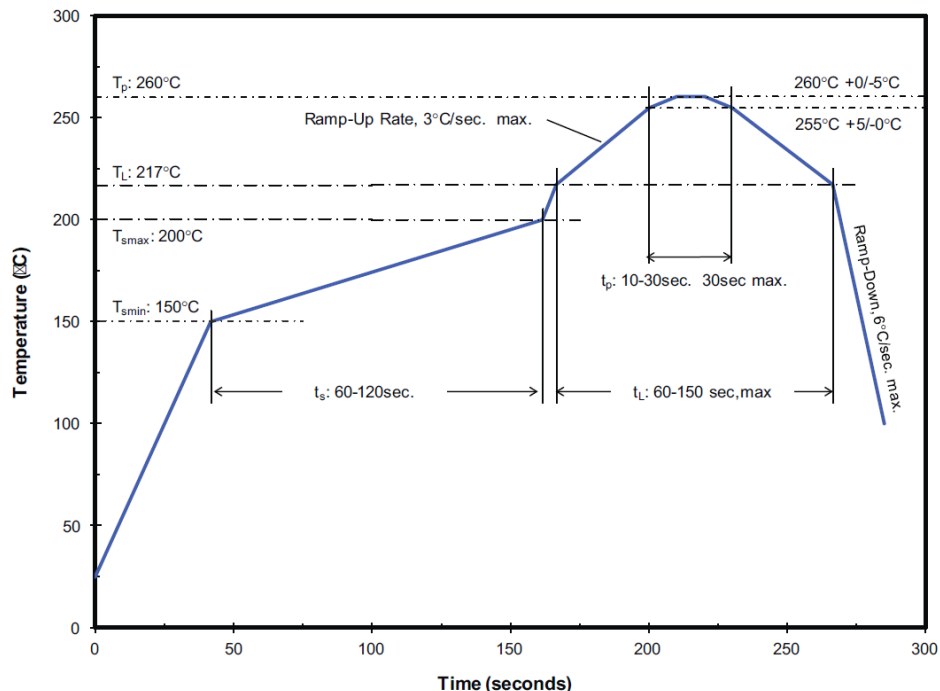

Figure 1. Temperature Profile for Table 5.

Table 5.

| Profile Feature | Lead Free Assembly |
|--|--------------------|
| Preheat/Soak: | |
| Temperature Min (T_{smin}) | 150°C |
| Temperature Max (T_{smax}) | 200°C |
| Maximum Time (t_s) from T_{smin} to T_{smax} | 120 seconds |
| Ramp-Up Rate (T_L to T_p) | 3°C / second |
| Liquidous Temperature (T_L) | 217°C |
| Maximum Time (t_L) Maintained T_L | 150 seconds |
| Maximum Peak Package Body Temperature (T_p) | 260°C |
| Time (t_p) Within 5°C of the Specified Temperature (T_C) | 10 - 30 seconds |
| Maximum Ramp-Down Rate (T_p to T_L) | 6°C / second |
| Maximum Time 25°C to Peak Temperature | 8 minutes |

Note for Table 5:

1. All temperatures refer to the application Printed Circuit Board (PCB), measured on the surface adjacent to the package body.

Mechanical Dimensions and Package Information

Mechanical Dimensions

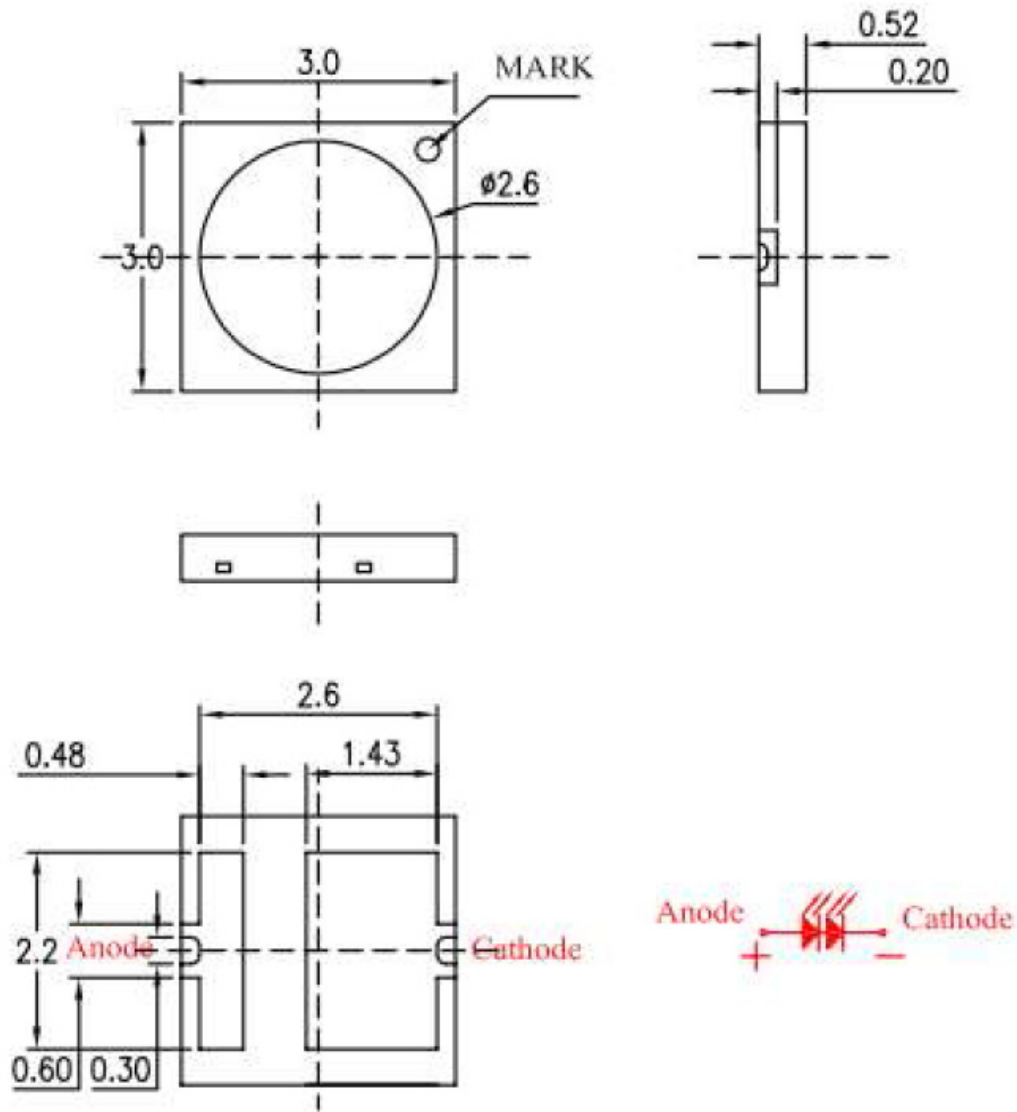

Figure 2.

Notes for Figure 2:

1. All dimensions are in millimeters.
2. Tolerance: X.X: $\pm 0.1\text{mm}$, X.XX: $\pm 0.05\text{mm}$, X.XXX: $\pm 0.05\text{mm}$.

Recommended Soldering Pad Pattern and Metal Solder Stencil Aperture

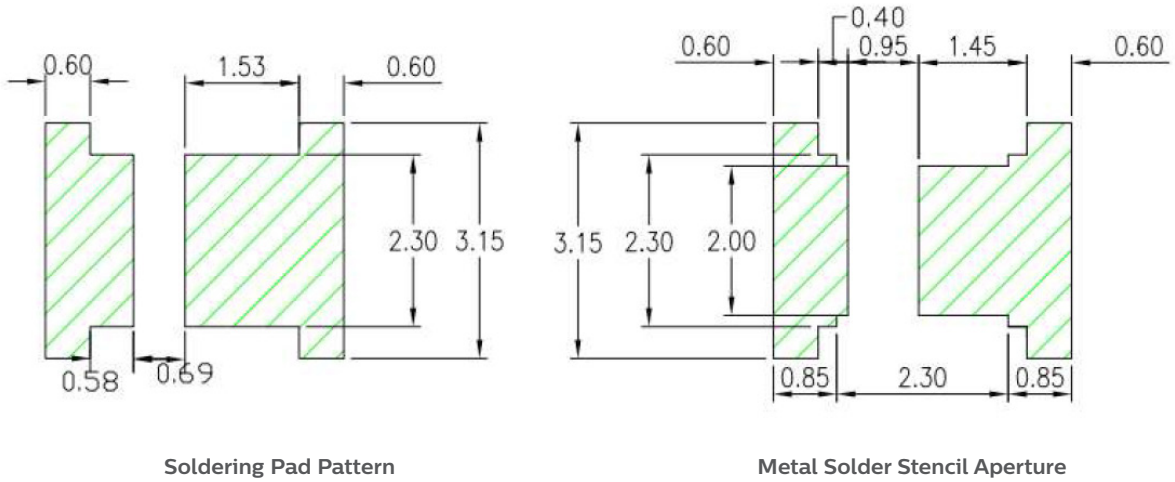

Figure 3.

Package Dimensions of Tape (Unit: mm)

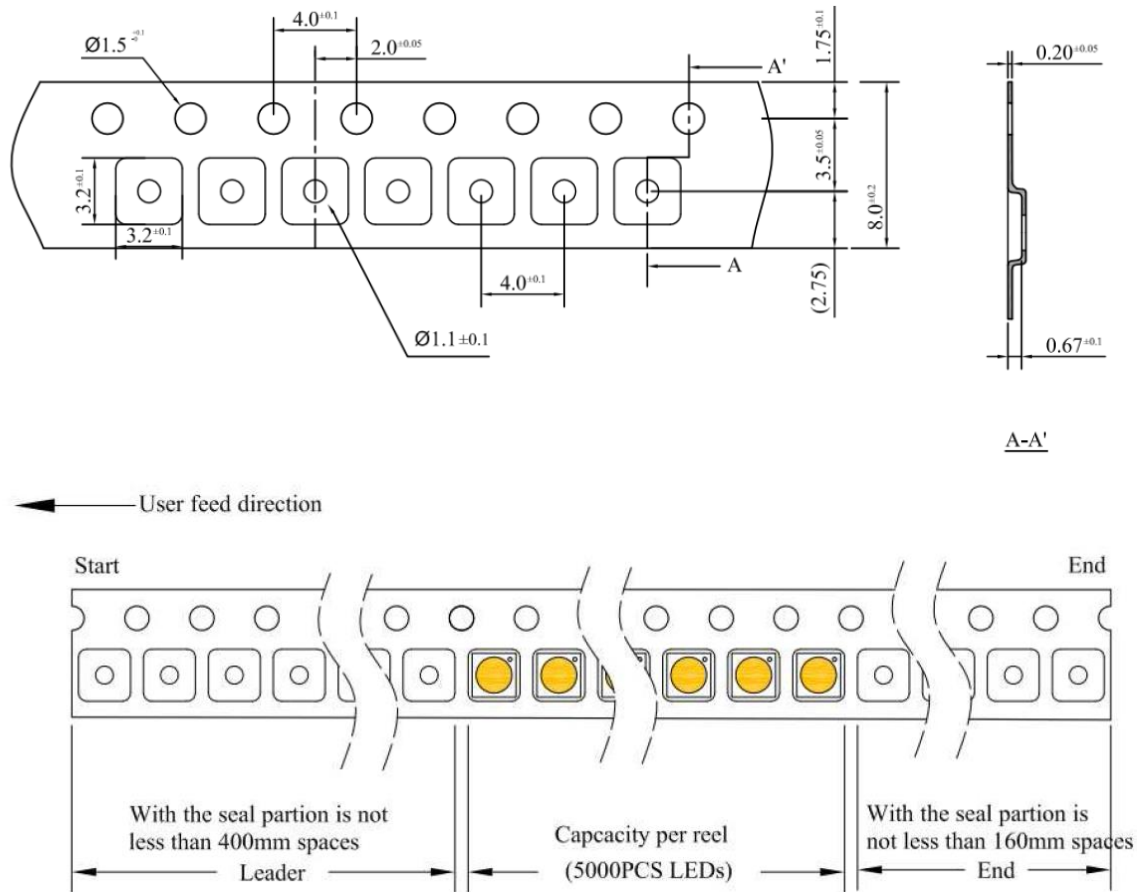

Figure 4.

Package Dimensions of Reel

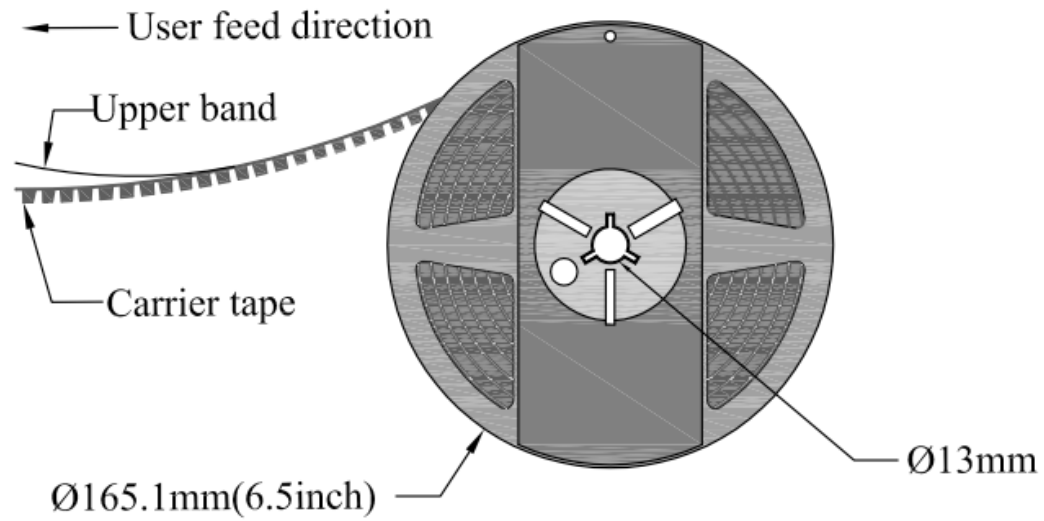

Figure 5. Reel dimensions.

Package Labeling

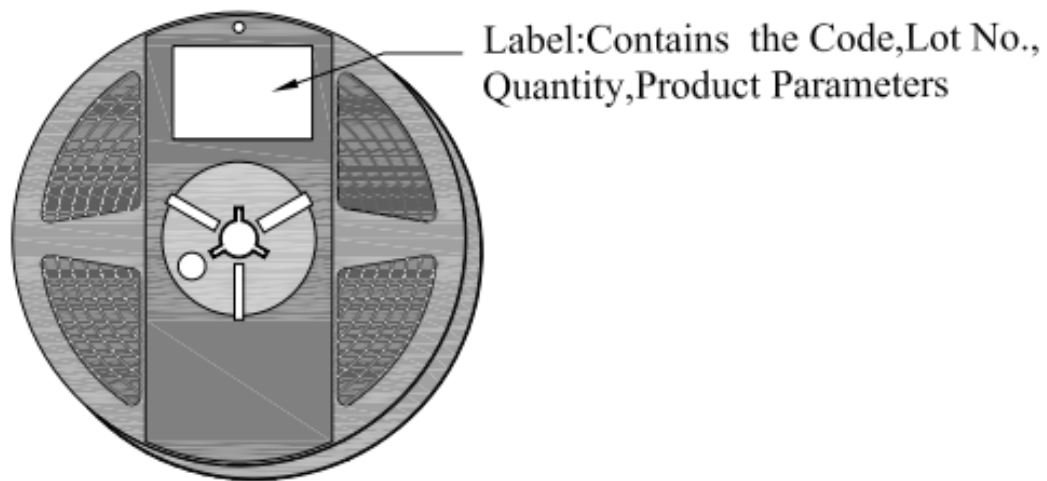

Figure 6. Label information.

Moisture Proof Package

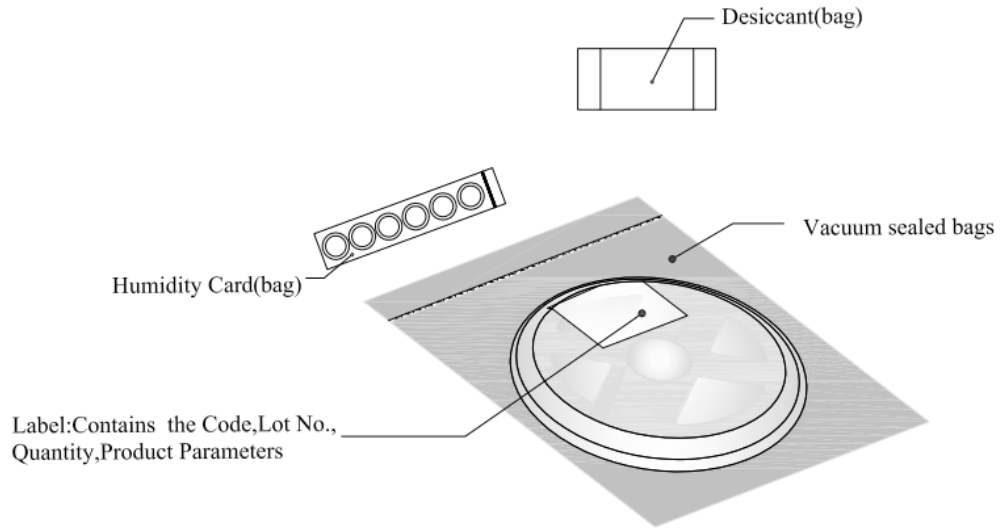

Figure 7. Vacuum sealed and moisture proof.

Relative Spectral Distribution

Relative Intensity vs. Wavelength

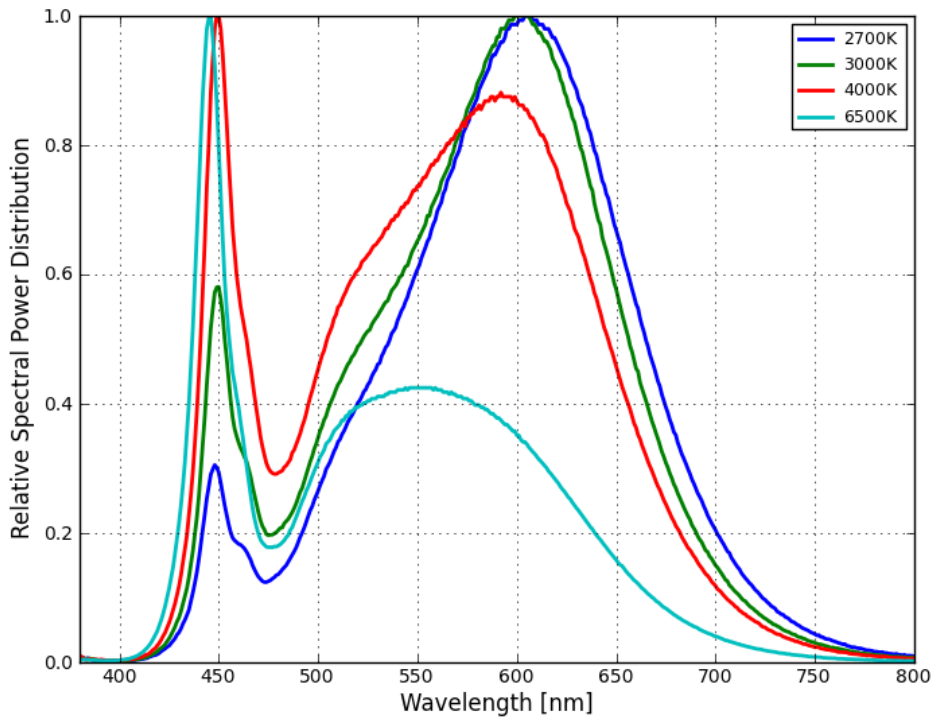

Figure 8. Typical color spectrum. Integrated measurement at solder pad temperature = 25°C, forward current = 120 mA.

Relative Flux vs. Temperature

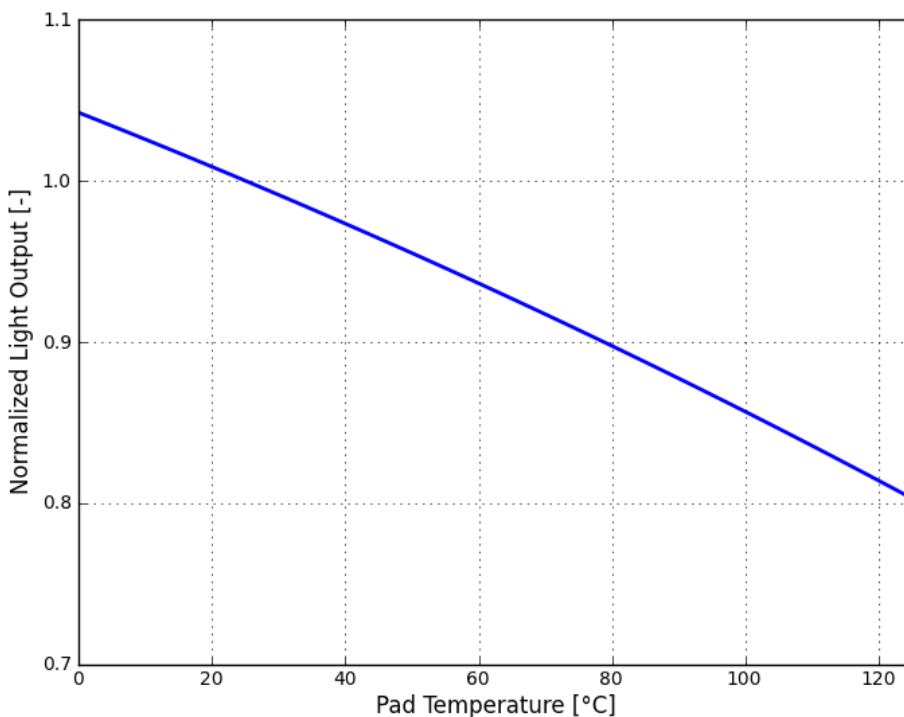

Figure 9. Typical relative light output vs. solder pad temperature, forward current = 120 mA.

Relative Flux vs. Forward Current

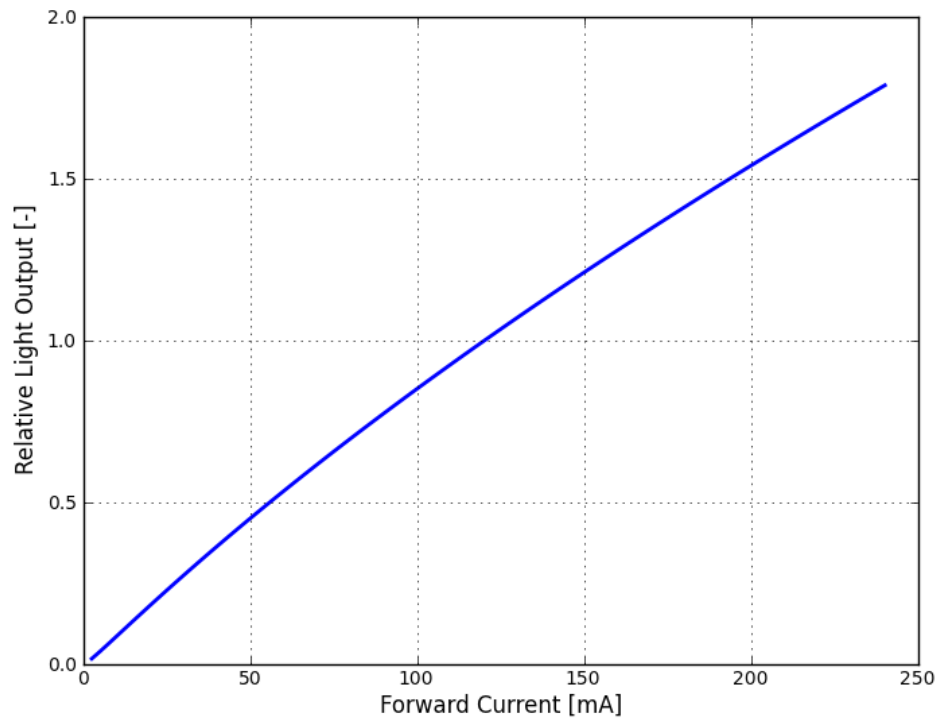

Figure 10. Typical relative light output vs. forward current = 120 mA, solder pad temperature = 25°C.

Forward Current vs. Forward Voltage

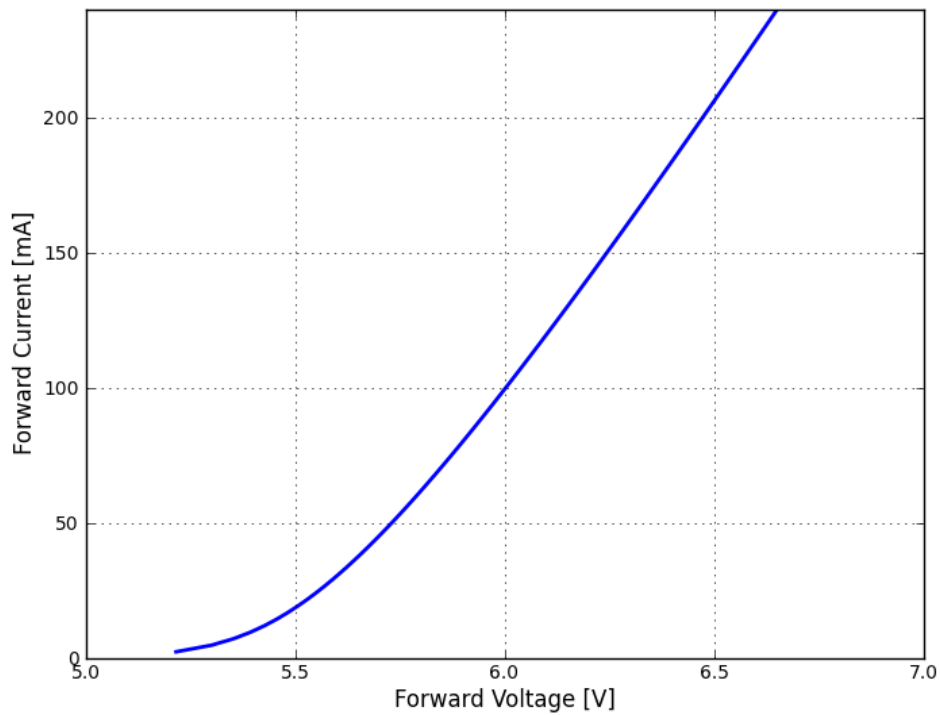

Figure 11. Typical forward current vs. forward voltage, solder pad temperature = 25°C.

Typical Radiation Patterns

Radiation in Cartesian coordinate system

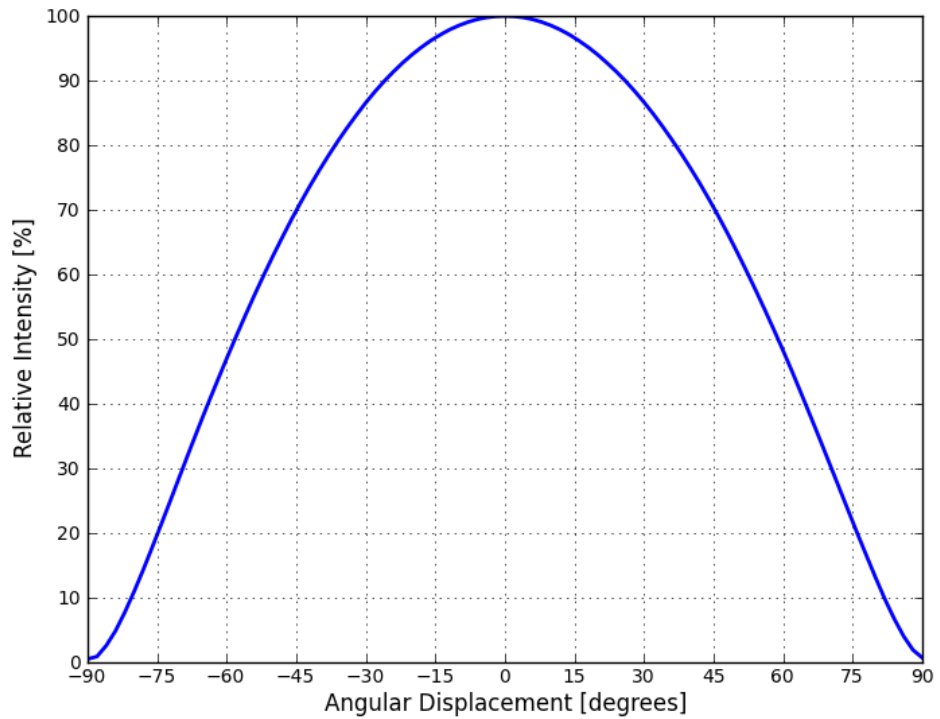

Figure 12. Typical radiation pattern in Cartesian coordinate system.

Radiation Pattern in Polar Coordinate System

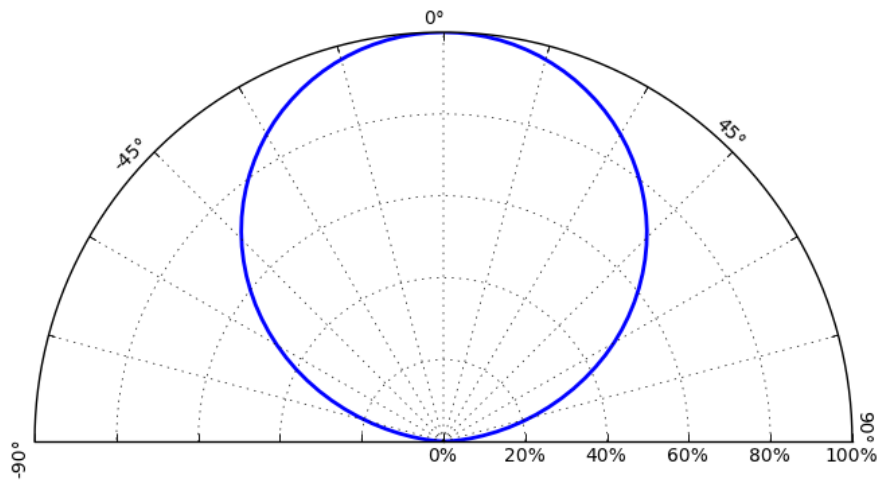

Figure 13. Typical radiation pattern in Polar coordinate system.

Product Binning and Labeling

Purpose of Product Binning

In the manufacturing of semiconductor products, there is a variation of performance around the average values given in the technical data sheets. For this reason, Philips Lumileds bins the LED components for luminous flux, color and forward voltage (V_f).

Decoding Product Bin Labeling

LUXEON mid-power emitters are labeled using a four digit alphanumeric code (CAT code) depicting the bin values for emitters packaged on a single reel. All emitters packaged within a reel are of the same 3-variable bin combination. Using these codes, it is possible to determine optimum mixing and matching of products for consistency in a given application.

Reels for all emitters are labeled with the CAT code following the format below.

ABCD

Where:

A = Flux bin (H etc.)

B & C = Color bin (For example 8D, 8E, 8F, etc.)

D = V_f bin

Luminous Flux Bins

Table 6 and Table 7 list the standard photometric luminous flux bins for LUXEON 3030 2D mid-power emitters (tested and binned at 120 mA and a junction temperature of 25°C). Although several bins are outlined, product availability in a particular bin varies by production run and by product performance. Not all bins are available in all colors. Please contact your Philips Lumileds representative for the supportable flux bins.

Table 6.

| Bin Code | Minimum Photometric Flux (lm) | Maximum Photometric Flux (lm) |
|----------|-------------------------------|-------------------------------|
| A | 50 | 55 |
| B | 55 | 60 |
| C | 60 | 65 |
| D | 65 | 70 |
| E | 70 | 75 |
| F | 75 | 80 |
| G | 80 | 85 |
| H | 85 | 90 |
| I | 90 | 95 |
| J | 95 | 100 |
| K | 100 | 105 |
| L | 105 | 110 |

Note for Table 6:

1. Tested and binned at 25°C, $I_f=120$ mA. Tester tolerance: $\pm 7.5\%$.

Forward Voltage Bins

Table 7.

| Bin Code | Minimum Forward Voltage (V) | Maximum Forward Voltage (V) |
|----------|-----------------------------|-----------------------------|
| F | 5.6 | 5.8 |
| G | 5.8 | 6.0 |
| H | 6.0 | 6.2 |
| I | 6.2 | 6.4 |
| J | 6.4 | 6.6 |

Note for Table 7:

1. Tested and binned at 25°C, $I_f=120$ mA.

Color Bin Structure

The LUXEON 3030 2D is hot color targeted so that at 85°C, the color is within ANSI.

Typical bin structure at 85°C

In application conditions, the LED temperature rises and at 85°C the typical color bins will be as shown.

Note: Bin *N will represent the entire ANSI bin for that corresponding CCT. For example, bin 7N will represent the entire bin for 3000K ANSI.

L130-2780003000W21 Color Bin Structure

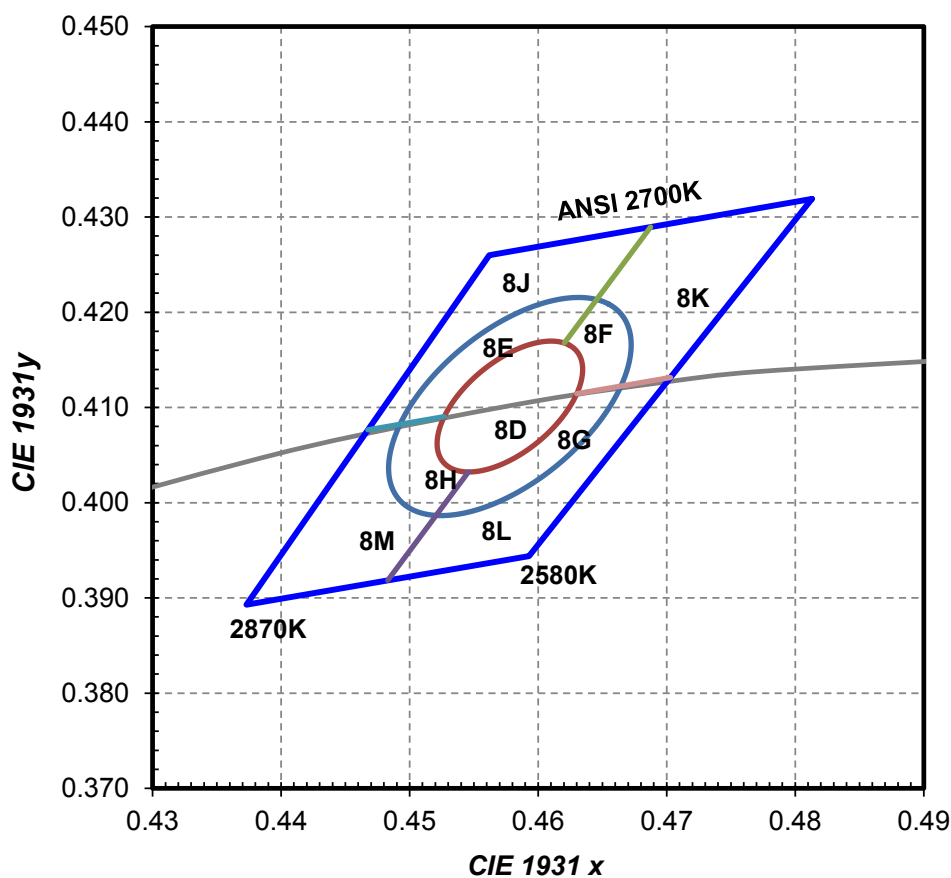

Figure 14. 2700K 1/9th color bin structure.

Table 8.

| Nominal ANSI CCT | Color Space | Target Center Point (cx, cy) | Major Axis, a | Minor Axis, b | Ellipse Rotation Angle |
|------------------|-------------------------------|------------------------------|---------------|---------------|------------------------|
| 2700K | Single 3-step MacAdam ellipse | (0.4578, 0.4101) | 0.00810 | 0.00420 | 53.70° |
| 2700K | Single 5-step MacAdam ellipse | (0.4578, 0.4101) | 0.01350 | 0.00700 | 53.70° |

L130-3080003000W21 Color Bin Structure

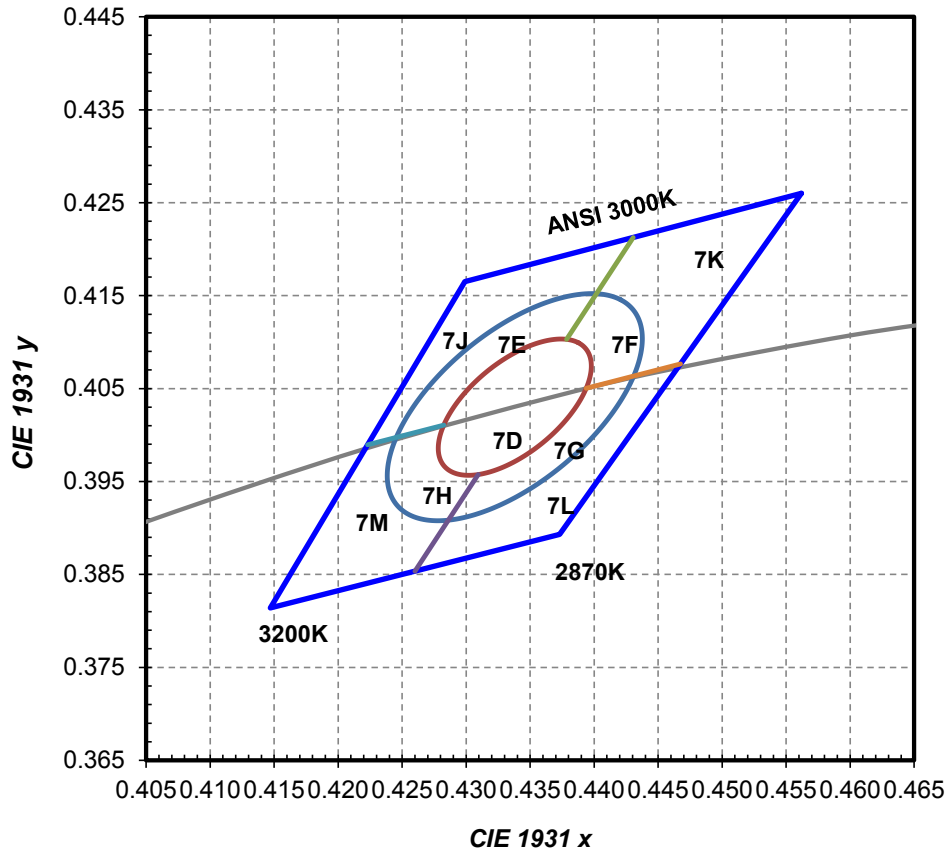

Figure 15. 3000K 1/9th color bin structure.

Table 9.

| Nominal ANSI CCT | Color Space | Target Center Point (cx, cy) | Major Axis, a | Minor Axis, b | Ellipse Rotation Angle |
|------------------|-------------------------------|------------------------------|---------------|---------------|------------------------|
| 3000K | Single 3-step MacAdam ellipse | (0.4338, 0.403) | 0.00834 | 0.00408 | 53.22° |
| 3000K | Single 5-step MacAdam ellipse | (0.4338, 0.403) | 0.01390 | 0.00680 | 53.22° |

L130-3580003000W21 Color Bin Structure

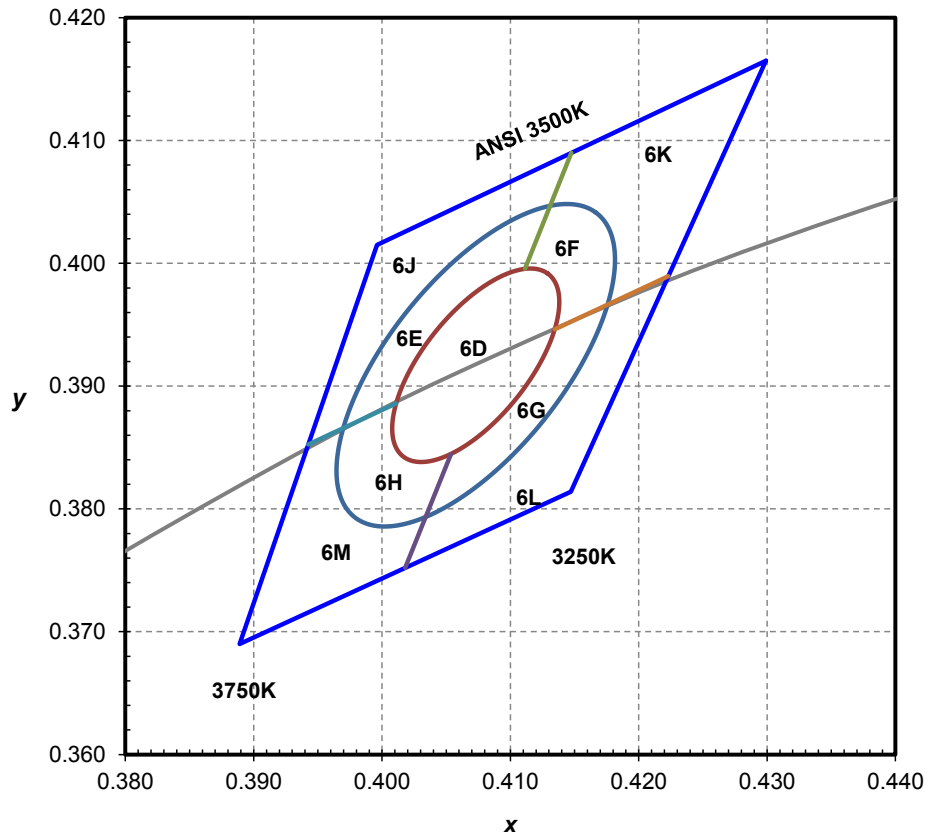

Figure 16. 3500K 1/9th color bin structure.

Table 10.

| Nominal ANSI CCT | Color Space | Target Center Point (cx, cy) | Major Axis, a | Minor Axis, b | Ellipse Rotation Angle |
|------------------|-------------------------------|------------------------------|---------------|---------------|------------------------|
| 3500K | Single 3-step MacAdam ellipse | (0.4073, 0.3917) | 0.00927 | 0.00414 | 53.22° |
| 3500K | Single 5-step MacAdam ellipse | (0.4073, 0.3917) | 0.01545 | 0.00690 | 53.22° |

L130-4080003000W21 Color Bin Structure

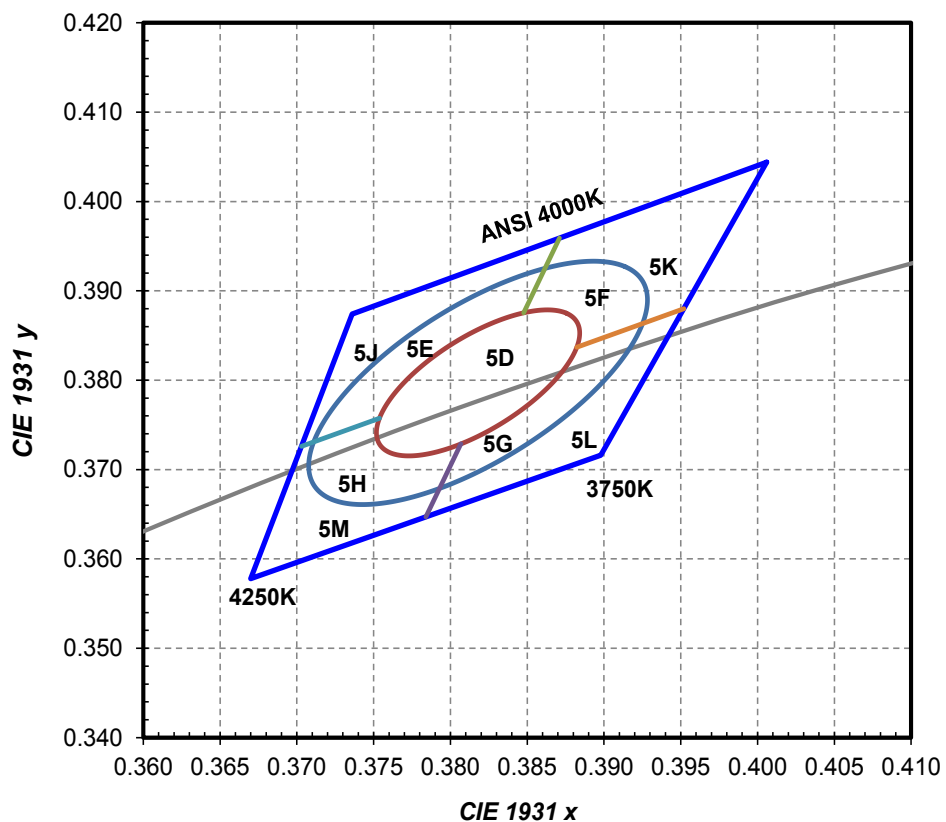

Figure 17. 4000K 1/9th color bin structure.

Table 11.

| Nominal ANSI CCT | Color Space | Target Center Point (cx, cy) | Major Axis, a | Minor Axis, b | Ellipse Rotation Angle |
|------------------|-------------------------------|------------------------------|---------------|---------------|------------------------|
| 4000K | Single 3-step MacAdam ellipse | (0.3818, 0.3797) | 0.00939 | 0.00402 | 53.72° |
| 4000K | Single 5-step MacAdam ellipse | (0.3818, 0.3797) | 0.01565 | 0.00670 | 53.72° |

L130-5080003000W21 Color Bin Structure

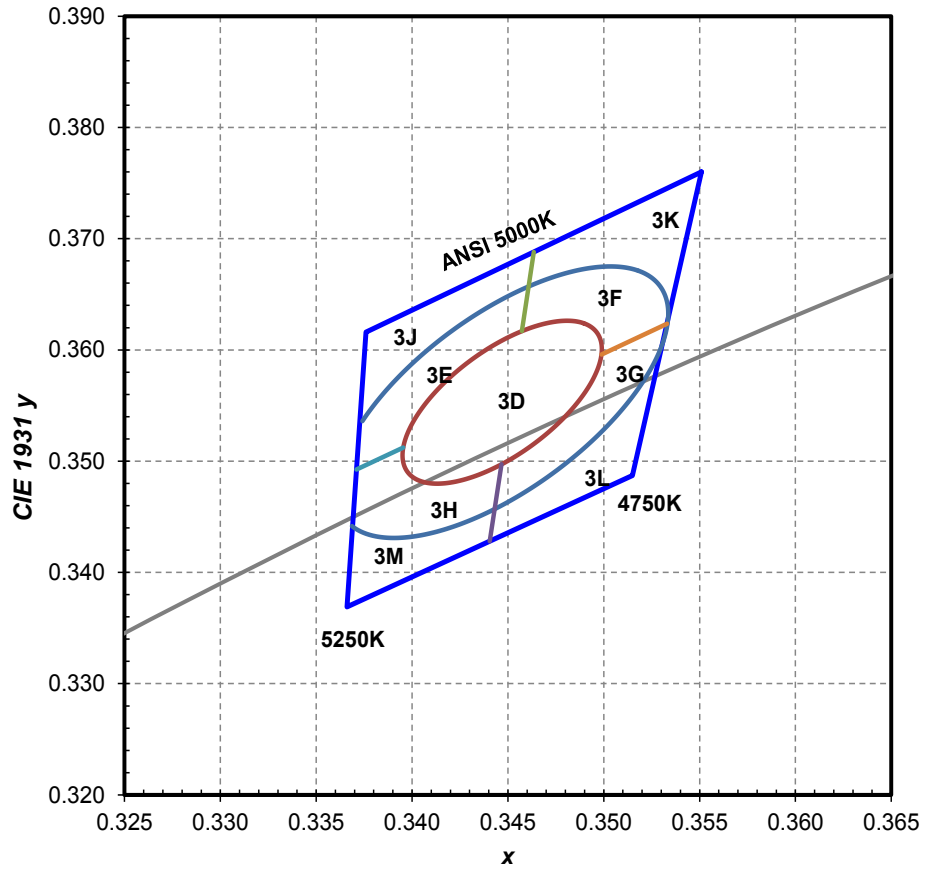

Figure 18. 5000K 1/9th color bin structure.

Table 12.

| Nominal ANSI CCT | Color Space | Target Center Point (cx, cy) | Major Axis, a | Minor Axis, b | Ellipse Rotation Angle |
|------------------|-------------------------------|------------------------------|---------------|---------------|------------------------|
| 5000K | Single 3-step MacAdam ellipse | (0.3447, 0.3553) | 0.00822 | 0.00354 | 59.62° |
| 5000K | Single 5-step MacAdam ellipse | (0.3447, 0.3553) | 0.01370 | 0.00590 | 59.62° |

L130-5780003000W21 Color Bin Structure

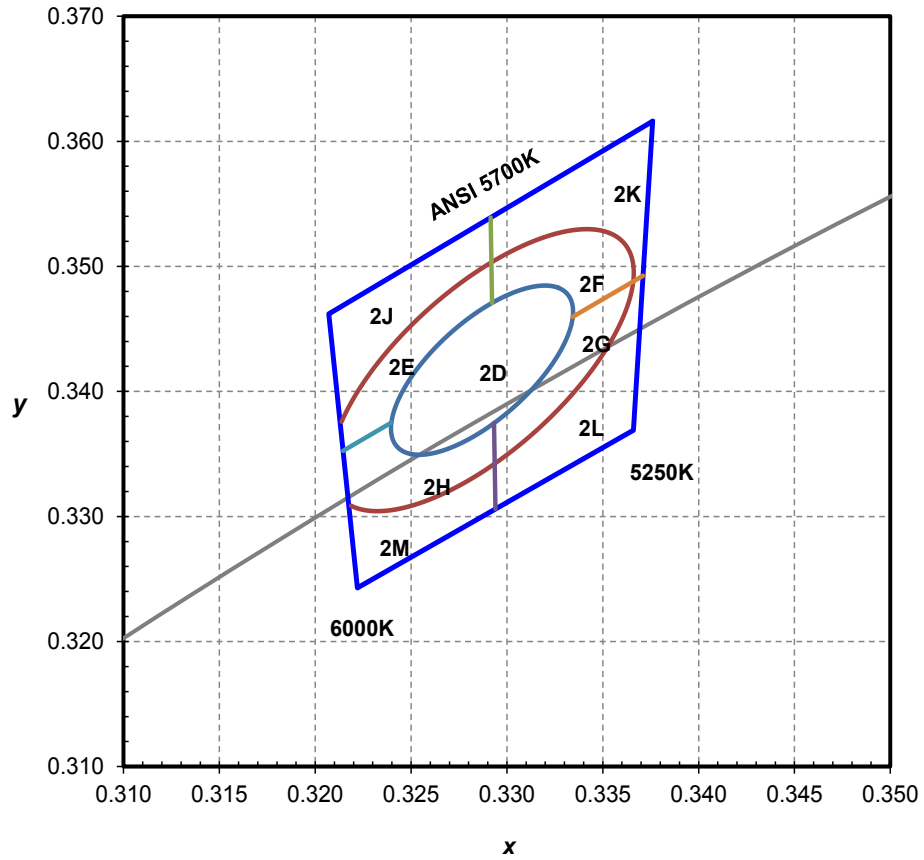

Figure 19. 5700K 1/9th color bin structure.

Table 13.

| Nominal ANSI CCT | Color Space | Target Center Point (cx, cy) | Major Axis, a | Minor Axis, b | Ellipse Rotation Angle |
|------------------|-------------------------------|------------------------------|---------------|---------------|------------------------|
| 5700K | Single 3-step MacAdam ellipse | (0.3287, 0.3417) | 0.00746 | 0.00320 | 59.09° |
| 5700K | Single 5-step MacAdam ellipse | (0.3287, 0.3417) | 0.01243 | 0.00533 | 59.09° |

L130-6580003000W21 Color Bin Structure

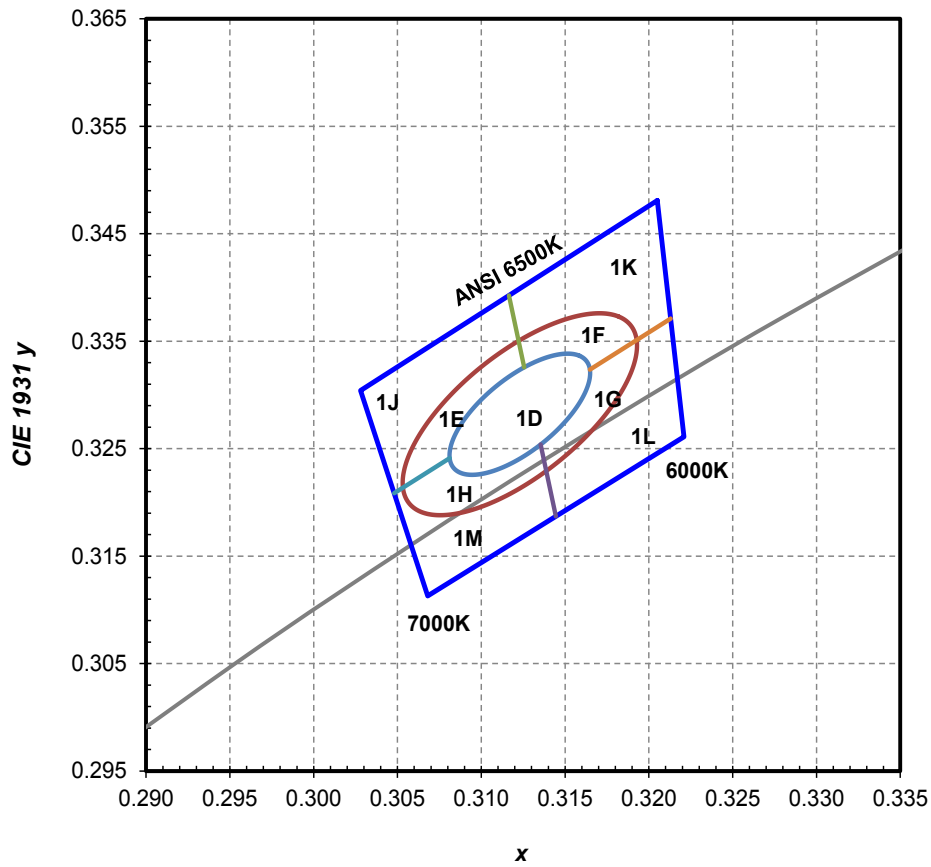

Figure 20. 6500K 1/9th color bin structure.

Table 14.

| Nominal ANSI CCT | Color Space | Target Center Point (cx, cy) | Major Axis, a | Minor Axis, b | Ellipse Rotation Angle |
|------------------|-------------------------------|------------------------------|---------------|---------------|------------------------|
| 6500K | Single 3-step MacAdam ellipse | (0.3123, 0.3282) | 0.00669 | 0.00285 | 58.57° |
| 6500K | Single 5-step MacAdam ellipse | (0.3123, 0.3282) | 0.01115 | 0.00475 | 58.57° |

Who We Are

Philips Lumileds focuses on one goal: Creating the world's highest performing LEDs. The company pioneered the use of solid-state lighting in breakthrough products such as the first LED backlit TV, the first LED flash in camera phones, and the first LED daytime running lights for cars. Today we offer the most comprehensive portfolio of high quality LEDs and uncompromising service.

Philips Lumileds brings LED's qualities of energy efficiency, digital control and long life to spotlights, downlights, high bay and low bay lighting, indoor area lighting, architectural and specialty lighting as well as retrofit lamps. Our products are engineered for optimal light quality and unprecedented efficacy at the lowest overall cost. By offering LEDs in chip, packaged and module form, we deliver supply chain flexibility to the inventors of next generation illumination.

Philips Lumileds understands that solid state lighting is not just about energy efficiency. It is about elegant design. Reinventing form. Engineering new materials. Pioneering markets and simplifying the supply chain. It's about a shared vision. Learn more about our comprehensive portfolio of LEDs at www.philipslumileds.com.

Philips Lumileds Lighting Company shall not be liable for any kind of loss of data or any other damages, direct, indirect or consequential, resulting from the use of the provided information and data. Although Philips Lumileds Lighting Company has attempted to provide the most accurate information and data, the materials and services information and data are provided "as is" and Philips Lumileds Lighting Company neither warranties, nor guarantees the contents and correctness of the provided information and data. Philips Lumileds Lighting Company reserves the right to make changes without notice. You as user agree to this disclaimer and user agreement with the download or use of the provided materials, information and data.



©2014 Philips Lumileds Lighting Company. All rights reserved.
LUXEON is a registered trademark of the Philips Lumileds Lighting Company in the United States and other countries.

www.philipslumileds.com
www.philipslumileds.cn.com