

PRODUCT FEATURES

- Ultrafast Reverse Recovery Time
- Soft Reverse Recovery Characteristics
- Low Reverse Recovery Loss
- Low Forward Voltage
- High Surge Current Capability
- Low Inductance Package



APPLICATIONS

- Inversion Welder
- Uninterruptible Power Supply (UPS)
- Plating Power Supply
- Ultrasonic Cleaner and Welder
- Converter & Chopper
- Power Factor Correction (PFC) Circuit

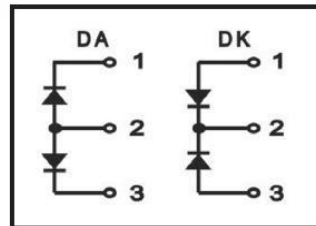

ABSOLUTE MAXIMUM RATINGS

$T_C=25^{\circ}\text{C}$ unless otherwise specified

Symbol	Parameter	Test Conditions	Values	Unit
V_R	Maximum D.C. Reverse Voltage		700	V
V_{RRM}	Maximum Repetitive Reverse Voltage		700	V
$I_{F(AV)}$	Average Forward Current	$T_C=90^{\circ}\text{C}$, Per Diode	100	A
		$T_C=90^{\circ}\text{C}$, Per Moudle	200	A
		$T_C=90^{\circ}\text{C}$, 20KHz, Per Moudle	150	A
$I_{F(RMS)}$	RMS Forward Current	$T_C=90^{\circ}\text{C}$, Per Diode	150	A
I_{FSM}	Non-Repetitive Surge Forward Current	$T_J=45^{\circ}\text{C}$, $t=10\text{ms}$, 50Hz, Sine	1100	A
		$T_J=45^{\circ}\text{C}$, $t=8.3\text{ms}$, 60Hz, Sine	1200	A
I^2t	I^2t (For Fusing)	$T_J=45^{\circ}\text{C}$, $t=10\text{ms}$, 50Hz, Sine	6050	A^2s
		$T_J=45^{\circ}\text{C}$, $t=8.3\text{ms}$, 60Hz, Sine	7200	A^2s
P_D	Power Dissipation		370	W
T_J	Junction Temperature		-40 to +150	$^{\circ}\text{C}$
T_{STG}	Storage Temperature Range		-40 to +125	$^{\circ}\text{C}$
V_{ISOL}	Insulation Test Voltage	AC, $t=1\text{min}$	3000	V
Torque	Module-to-Sink	Recommended (M5)	2.5~4	N·m
Torque	Module Electrodes	Recommended (M5)	2.5~4	N·m
$R_{\theta JC}$	Thermal Resistance	Junction-to-Case	0.34	$^{\circ}\text{C}/\text{W}$
Weight			100	g

ELECTRICAL CHARACTERISTICS

$T_C=25^\circ\text{C}$ unless otherwise specified

Symbol	Parameter	Test Conditions	Min.	Typ.	Max.	Unit
I_{RM}	Reverse Leakage Current	$V_R=700\text{V}$	--	--	1	mA
		$V_R=700\text{V}, T_J=125^\circ\text{C}$	--	--	2	mA
V_F	Forward Voltage	$I_F=100\text{A}$	--	1.55	1.9	V
		$I_F=100\text{A}, T_J=125^\circ\text{C}$	--	--	1.6	V
t_{rr}	Reverse Recovery Time	$I_F=1\text{A}, V_R=30\text{V}, di_F/dt=-200\text{A}/\mu\text{s}$	--	38	--	ns
t_{rr}	Reverse Recovery Time	$V_R=350\text{V}, I_F=100\text{A}$	--	85	--	ns
I_{RRM}	Max. Reverse Recovery Current		$di_F/dt=-200\text{A}/\mu\text{s}, T_J=25^\circ\text{C}$	--	10	--
t_{rr}	Reverse Recovery Time	$V_R=350\text{V}, I_F=100\text{A}$	--	180	--	ns
I_{RRM}	Max. Reverse Recovery Current		$di_F/dt=-200\text{A}/\mu\text{s}, T_J=125^\circ\text{C}$	--	22	--

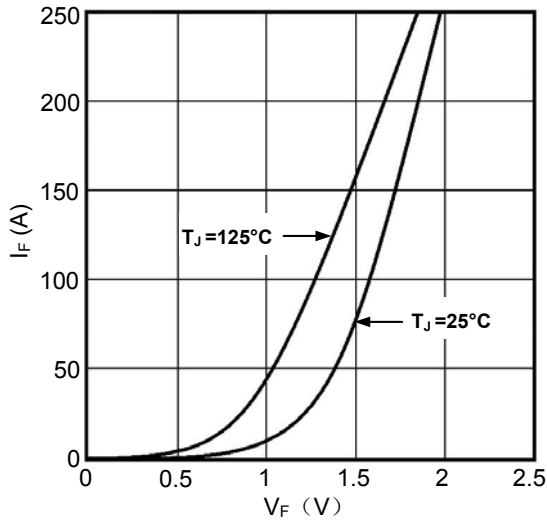

Figure1. Forward Voltage Drop vs Forward Current

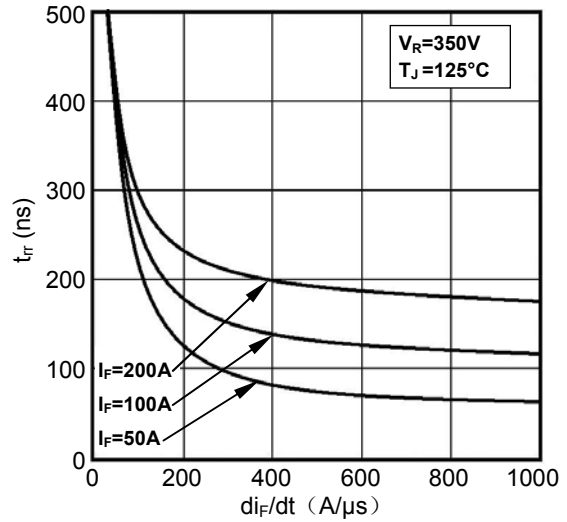

Figure2. Reverse Recovery Time vs di_F/dt

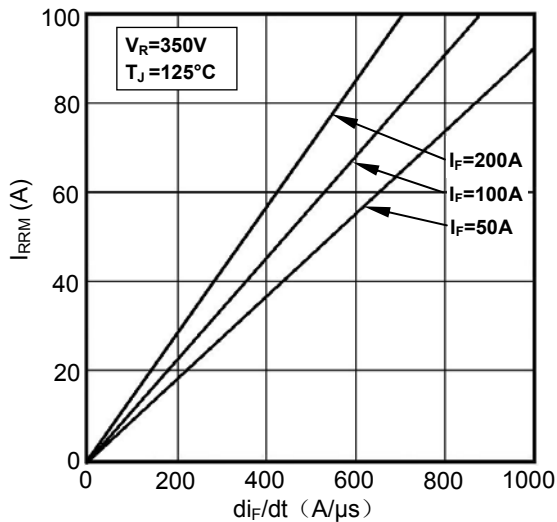

Figure3. Reverse Recovery Current vs di_F/dt

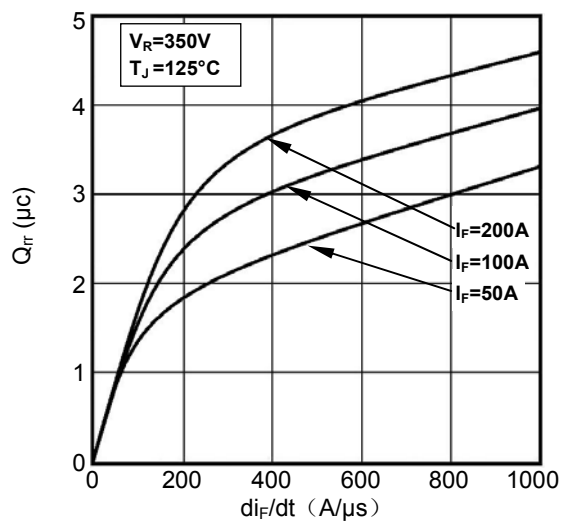

Figure4. Reverse Recovery Charge vs di_F/dt

MIMMF200N070DA
MIMMF200N070DK

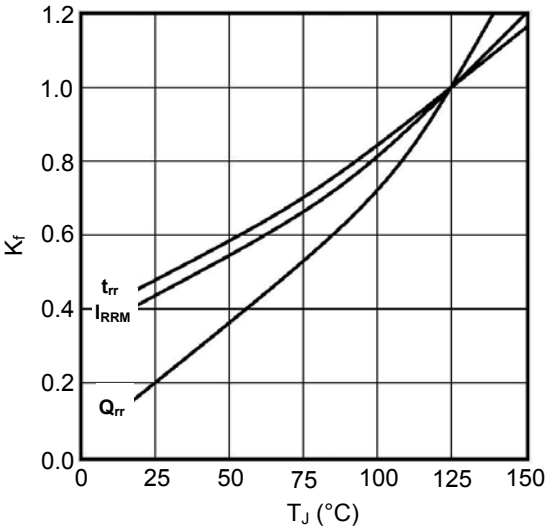

Figure5. Dynamic Parameters vs Junction Temperature

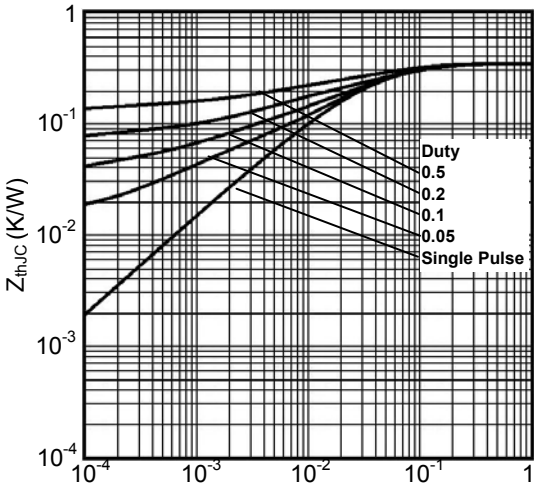
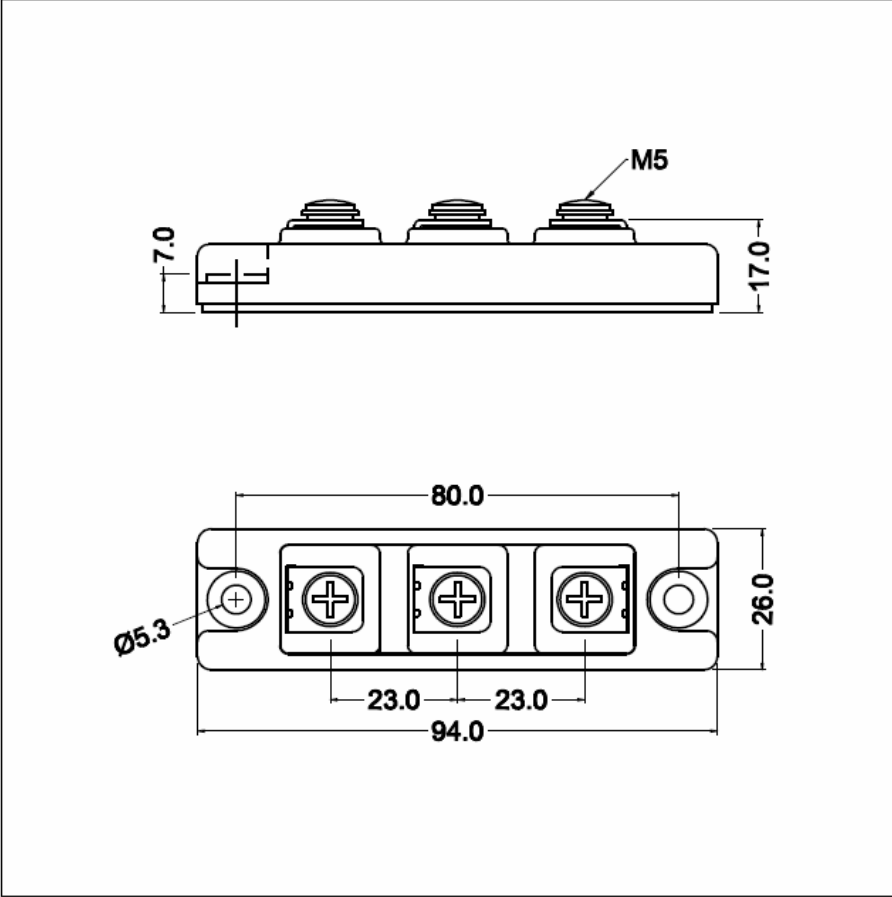

Figure6. Transient Thermal Impedance



Dimensions (mm)
 Figure7. Package Outline