

# High Voltage Power MOSFETs w/ Extended FBSOA

## IXTK20N150 IXTX20N150

$V_{DSS} = 1500V$   
 $I_{D25} = 20A$   
 $R_{DS(on)} \leq 1\Omega$

N-Channel Enhancement Mode  
 Avalanche Rated  
 Guaranteed FBSOA

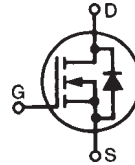

| Symbol        | Test Conditions  | Maximum Ratings   |            |
|---------------|--|-------------------|------------|
| $V_{DSS}$     | $T_J = 25^\circ C$ to $150^\circ C$                                | 1500              | V          |
| $V_{DGR}$     | $T_J = 25^\circ C$ to $150^\circ C$ , $R_{GS} = 1M\Omega$          | 1500              | V          |
| $V_{GSS}$     | Continuous   | $\pm 30$          | V          |
| $V_{GSM}$     | Transient  | $\pm 40$          | V          |
| $I_{D25}$     | $T_C = 25^\circ C$   | 20                | A          |
| $I_{DM}$      | $T_C = 25^\circ C$ , Pulse Width Limited by $T_{JM}$               | 50                | A          |
| $I_A$         | $T_C = 25^\circ C$   | 10                | A          |
| $E_{AS}$      | $T_C = 25^\circ C$   | 2.5               | J          |
| $dv/dt$       | $I_S \leq I_{DM}$ , $V_{DD} \leq V_{DSS}$ , $T_J \leq 150^\circ C$ | 5                 | V/ns       |
| $P_D$         | $T_C = 25^\circ C$   | 1250              | W          |
| $T_J$         |  | -55 to +150       | $^\circ C$ |
| $T_{JM}$      |  | 150               | $^\circ C$ |
| $T_{stg}$     |  | -55 to +150       | $^\circ C$ |
| $T_L$         | 1.6mm (0.062 in.) from Case for 10s                                | 300               | $^\circ C$ |
| $T_{SOLD}$    | Plastic Body for 10s   | 260               | $^\circ C$ |
| $M_d$         | Mounting Torque (TO-264)   | 1.13/10           | Nm/lb.in.  |
| $F_C$         | Mounting Force (PLUS247)   | 20..120 / 4.5..27 | N/lb.      |
| <b>Weight</b> | TO-264   | 10                | g          |
|               | PLUS247  | 6                 | g          |

### TO-264 (IXTK)

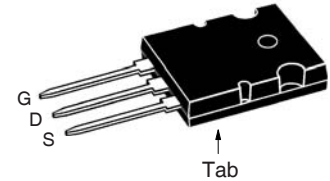

### PLUS247 (IXTX)

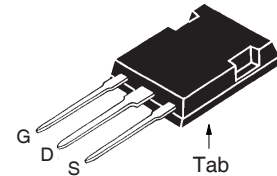

G = Gate      D = Drain  
 S = Source    Tab = Drain

### Features

- Avalanche Rated
- Fast Intrinsic Diode
- Guaranteed FBSOA at  $75^\circ C$
- Low Package Inductance

### Advantages

- Easy to Mount
- Space Savings

### Applications

- High Voltage Power Supplies
- Capacitor Discharge
- Pulse Circuits

| Symbol       | Test Conditions   | Characteristic Values |      |              |
|--------------|---|-----------------------|------|--------------|
|              |   | Min.                  | Typ. | Max.         |
| $BV_{DSS}$   | $V_{GS} = 0V$ , $I_D = 1mA$                               | 1500                  |      | V            |
| $V_{GS(th)}$ | $V_{DS} = V_{GS}$ , $I_D = 1mA$                           | 2.5                   |      | 4.5 V        |
| $I_{GSS}$    | $V_{GS} = \pm 30V$ , $V_{DS} = 0V$                        |                       |      | $\pm 200$ nA |
| $I_{DSS}$    | $V_{DS} = V_{DSS}$ , $V_{GS} = 0V$<br>$T_J = 125^\circ C$ |                       |      | 50 $\mu A$   |
|              |   |                       |      | 750 $\mu A$  |
| $R_{DS(on)}$ | $V_{GS} = 10V$ , $I_D = 0.5 \cdot I_{D25}$ , Note 1       |                       |      | 1 $\Omega$   |

| Symbol       | Test Conditions<br>( $T_J = 25^\circ\text{C}$ , Unless Otherwise Specified)  | Characteristic Values  |      |                    |
|--------------|--|--|------|--------------------|
|              |  | Min.   | Typ. | Max.               |
| $g_{fs}$     | $V_{DS} = 30\text{V}$ , $I_D = 0.5 \cdot I_{D25}$ , Note 1   | 14   | 24   | S                  |
| $C_{iss}$    | $V_{GS} = 0\text{V}$ , $V_{DS} = 25\text{V}$ , $f = 1\text{MHz}$   |  | 7800 | pF                 |
| $C_{oss}$    |  |  | 487  | pF                 |
| $C_{rss}$    |  |  | 163  | pF                 |
| $t_{d(on)}$  | <b>Resistive Switching Times</b><br>$V_{GS} = 10\text{V}$ , $V_{DS} = 0.5 \cdot V_{DSS}$ , $I_D = 0.5 \cdot I_{D25}$<br>$R_G = 1\Omega$ (External) |  | 35   | ns                 |
| $t_r$        |  |  | 30   | ns                 |
| $t_{d(off)}$ |  |  | 80   | ns                 |
| $t_f$        |  |  | 33   | ns                 |
| $Q_{g(on)}$  |  | $V_{GS} = 10\text{V}$ , $V_{DS} = 0.5 \cdot V_{DSS}$ , $I_D = 0.5 \cdot I_{D25}$ |      | 215                |
| $Q_{gs}$     |  |  | 40   | nC                 |
| $Q_{gd}$     |  |  | 93   | nC                 |
| $R_{thJC}$   |  |  | 0.10 | $^\circ\text{C/W}$ |
| $R_{thCS}$   |  | 0.15   |      | $^\circ\text{C/W}$ |

### Safe Operating Area Specification

| Symbol     | Test Conditions   | Characteristic Values |      |      |
|------------|---|-----------------------|------|------|
|            |   | Min.                  | Typ. | Max. |
| <b>SOA</b> | $V_{DS} = 1500\text{V}$ , $I_D = 133\text{mA}$ , $T_C = 75^\circ\text{C}$ , $t_p = 3\text{s}$ | 200                   |      | W    |

### Source-Drain Diode

| Symbol   | Test Conditions<br>( $T_J = 25^\circ\text{C}$ Unless Otherwise Specified)                             | Characteristic Values |      |               |
|----------|---|-----------------------|------|---------------|
|          |   | Min.                  | Typ. | Max.          |
| $I_S$    | $V_{GS} = 0\text{V}$  |                       |      | 20 A          |
| $I_{SM}$ | Repetitive, Pulse Width Limited by $T_{JM}$   |                       |      | 80 A          |
| $V_{SD}$ | $I_F = I_S$ , $V_{GS} = 0\text{V}$ , Note 1   |                       |      | 1.5 V         |
| $t_{rr}$ | $I_F = 10\text{A}$ , $-di/dt = 100\text{A}/\mu\text{s}$<br>$V_R = 100\text{V}$ , $V_{GS} = 0\text{V}$ |                       | 1.1  | $\mu\text{s}$ |
| $Q_{RM}$ |   |                       | 1.8  | $\mu\text{C}$ |
| $I_{RM}$ |   |                       | 32   | A             |

Note: 1. Pulse test,  $t \leq 300\mu\text{s}$ , duty cycle,  $d \leq 2\%$ .

IXYS Reserves the Right to Change Limits, Test Conditions, and Dimensions.

IXYS MOSFETs and IGBTs are covered by one or more of the following U.S. patents:

|           |           |           |           |              |              |              |              |              |             |
|-----------|-----------|-----------|-----------|--------------|--------------|--------------|--------------|--------------|-------------|
| 4,835,592 | 4,931,844 | 5,049,961 | 5,237,481 | 6,162,665    | 6,404,065 B1 | 6,683,344    | 6,727,585    | 7,005,734 B2 | 7,157,338B2 |
| 4,860,072 | 5,017,508 | 5,063,307 | 5,381,025 | 6,259,123 B1 | 6,534,343    | 6,710,405 B2 | 6,759,692    | 7,063,975 B2 |             |
| 4,881,106 | 5,034,796 | 5,187,117 | 5,486,715 | 6,306,728 B1 | 6,583,505    | 6,710,463    | 6,771,478 B2 | 7,071,537    |             |

### TO-264 Outline

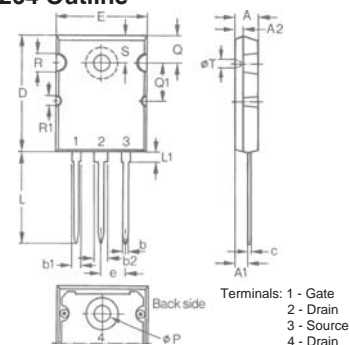

| Dim. | Millimeter |       | Inches   |       |
|------|------------|-------|----------|-------|
|      | Min.       | Max.  | Min.     | Max.  |
| A    | 4.82       | 5.13  | .190     | .202  |
| A1   | 2.54       | 2.89  | .100     | .114  |
| A2   | 2.00       | 2.10  | .079     | .083  |
| b    | 1.12       | 1.42  | .044     | .056  |
| b1   | 2.39       | 2.69  | .094     | .106  |
| b2   | 2.90       | 3.09  | .114     | .122  |
| c    | 0.53       | 0.83  | .021     | .033  |
| D    | 25.91      | 26.16 | 1.020    | 1.030 |
| E    | 19.81      | 19.96 | .780     | .786  |
| e    | 5.46 BSC   |       | .215 BSC |       |
| J    | 0.00       | 0.25  | .000     | .010  |
| K    | 0.00       | 0.25  | .000     | .010  |
| L    | 20.32      | 20.83 | .800     | .820  |
| L1   | 2.29       | 2.59  | .090     | .102  |
| P    | 3.17       | 3.66  | .125     | .144  |
| Q    | 6.07       | 6.27  | .239     | .247  |
| Q1   | 8.38       | 8.69  | .330     | .342  |
| R    | 3.81       | 4.32  | .150     | .170  |
| R1   | 1.78       | 2.29  | .070     | .090  |
| S    | 6.04       | 6.30  | .238     | .248  |
| T    | 1.57       | 1.83  | .062     | .072  |

### PLUS247™ Outline

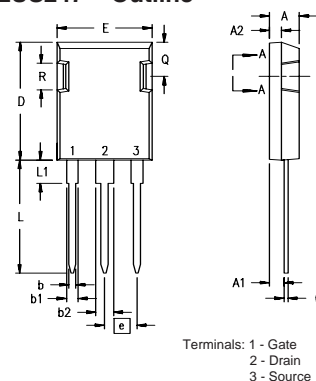

| Dim.           | Millimeter |       | Inches   |       |
|----------------|------------|-------|----------|-------|
|                | Min.       | Max.  | Min.     | Max.  |
| A              | 4.83       | 5.21  | .190     | .205  |
| A <sub>1</sub> | 2.29       | 2.54  | .090     | .100  |
| A <sub>2</sub> | 1.91       | 2.16  | .075     | .085  |
| b              | 1.14       | 1.40  | .045     | .055  |
| b <sub>1</sub> | 1.91       | 2.13  | .075     | .084  |
| b <sub>2</sub> | 2.92       | 3.12  | .115     | .123  |
| C              | 0.61       | 0.80  | .024     | .031  |
| D              | 20.80      | 21.34 | .819     | .840  |
| E              | 15.75      | 16.13 | .620     | .635  |
| e              | 5.45 BSC   |       | .215 BSC |       |
| L              | 19.81      | 20.32 | .780     | .800  |
| L1             | 3.81       | 4.32  | .150     | .170  |
| Q              | 5.59       | 6.20  | .220     | 0.244 |
| R              | 4.32       | 4.83  | .170     | .190  |

**Fig. 1. Output Characteristics @  $T_J = 25^\circ\text{C}$**

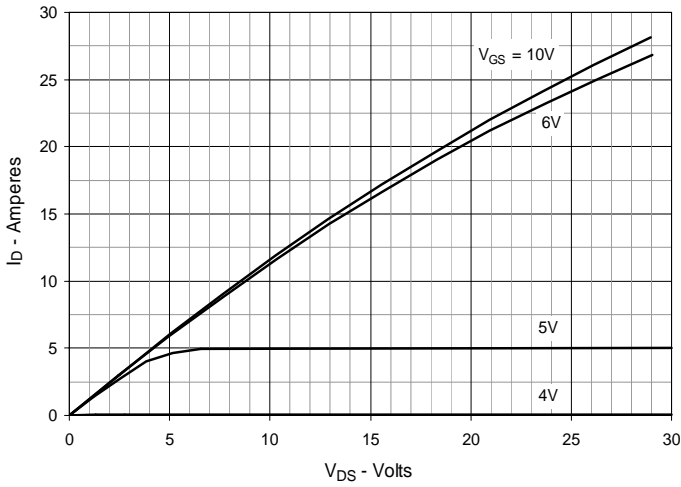

**Fig. 2. Output Characteristics @  $T_J = 125^\circ\text{C}$**

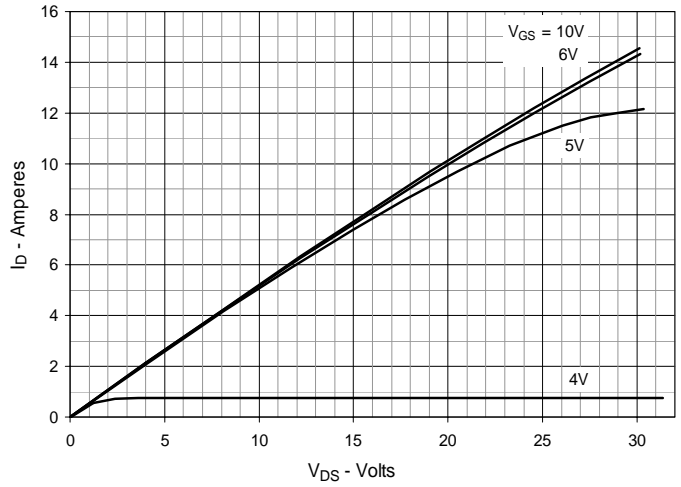

**Fig. 3.  $R_{DS(on)}$  Normalized to  $I_D = 10\text{A}$  Value vs. Junction Temperature**

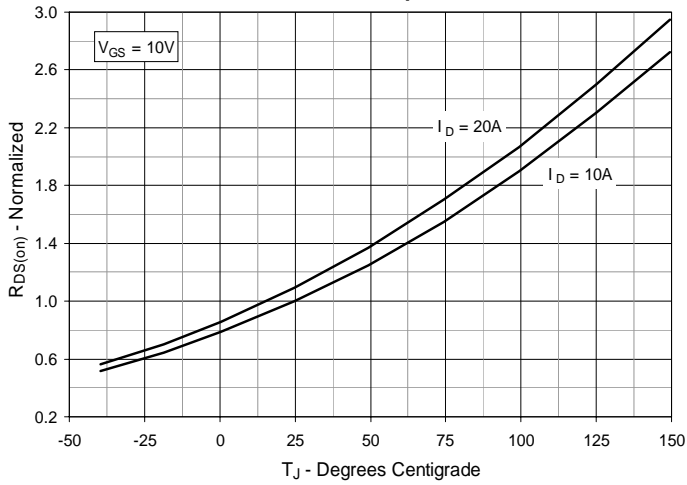

**Fig. 4.  $R_{DS(on)}$  Normalized to  $I_D = 10\text{A}$  Value vs. Drain Current**

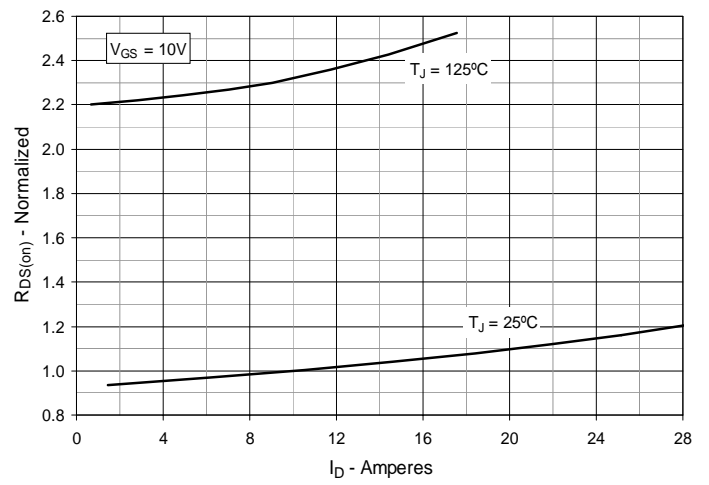

**Fig. 5. Maximum Drain Current vs. Case Temperature**

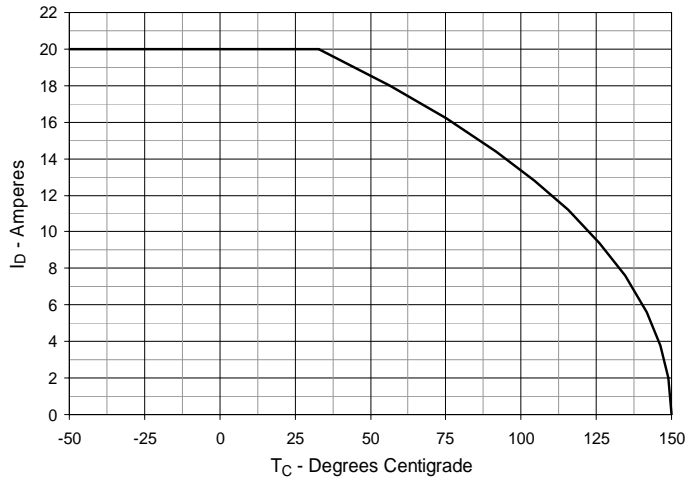

**Fig. 6. Input Admittance**

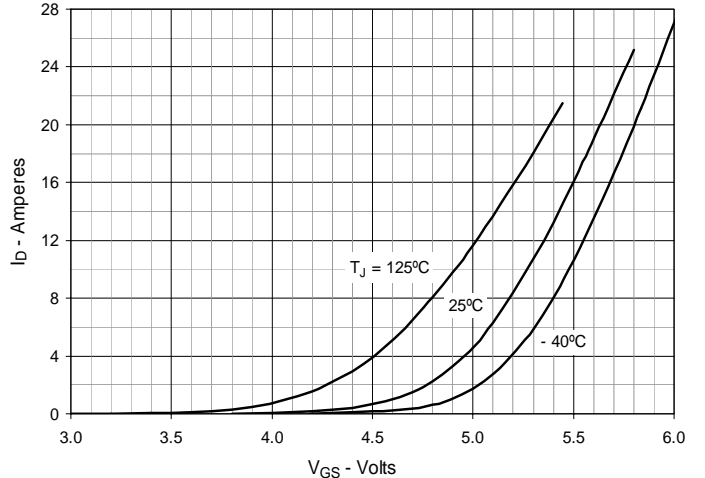

**Fig. 7. Transconductance**

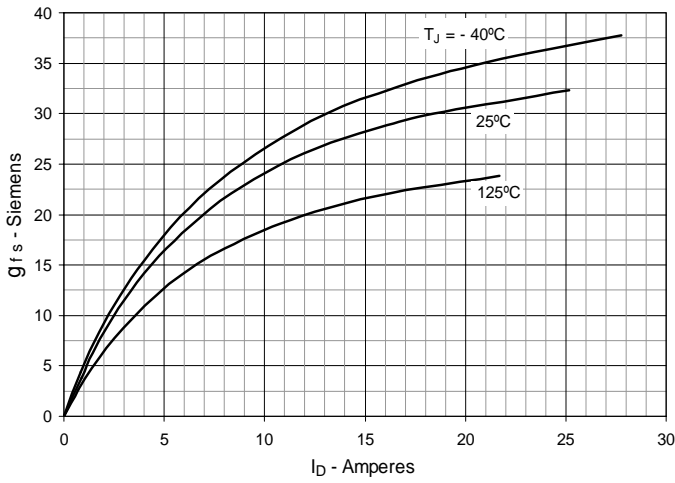

**Fig. 8. Forward Voltage Drop of Intrinsic Diode**

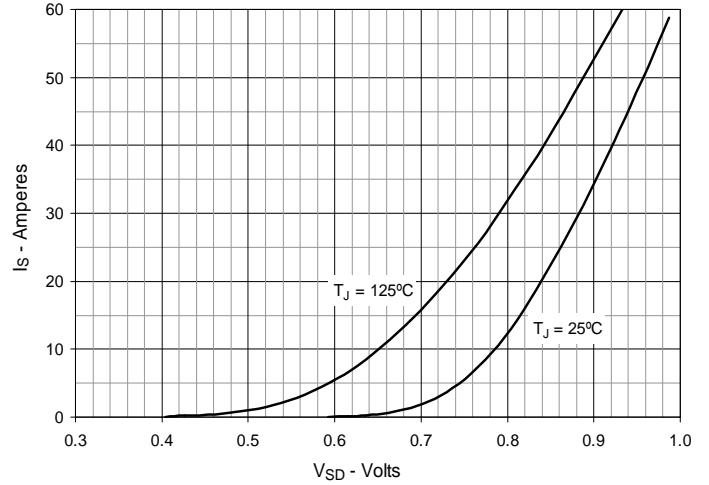

**Fig. 9. Gate Charge**

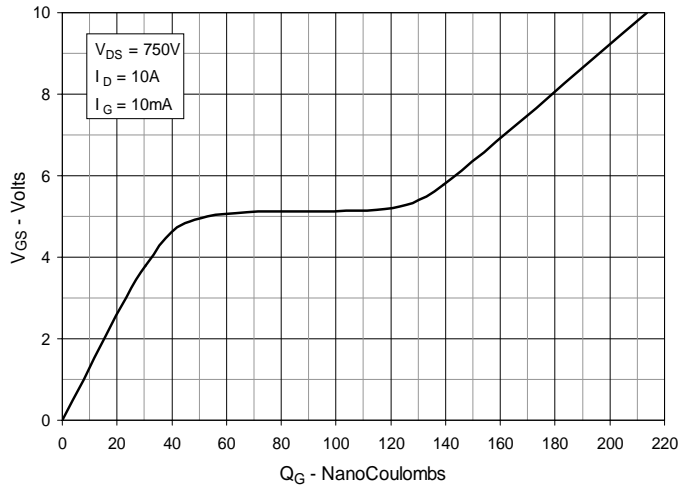

**Fig. 10. Capacitance**

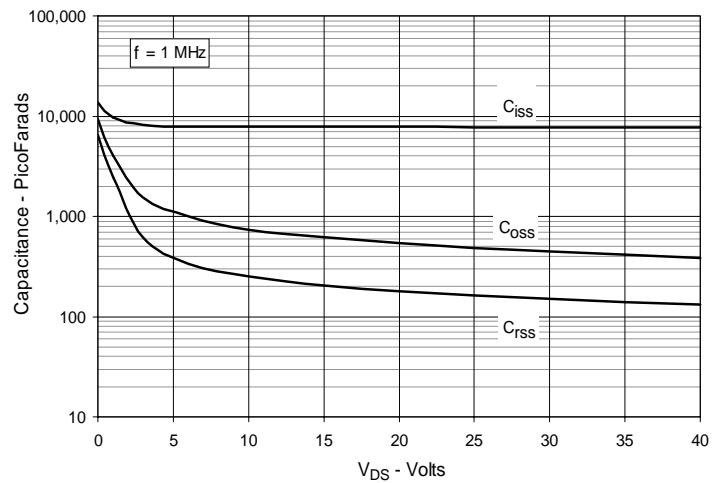

**Fig. 11. Forward-Bias Safe Operating Area**  
**@  $T_C = 25^\circ\text{C}$**

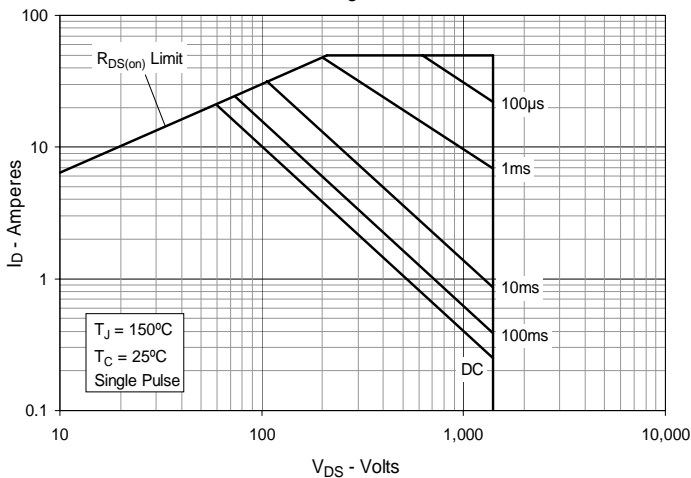

**Fig. 12. Forward-Bias Safe Operating Area**  
**@  $T_C = 75^\circ\text{C}$**

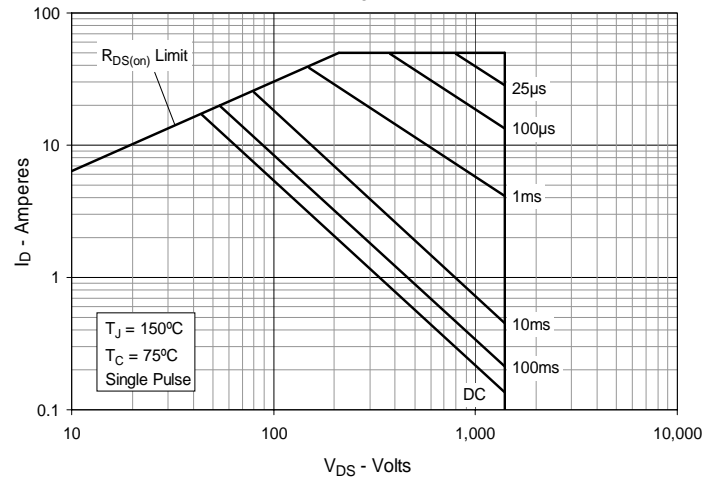

Fig. 13. Maximum Transient Thermal Impedance

