

# μPD5753T7G

SiGe/CMOS Integrated Circuit

4 × 2 IF Switch Matrix with Tone/Voltage Controller

R09DS0014EJ0100

Rev.1.00

Feb 22, 2011

## FEATURES

- 4 independent IF channels, integral switching to channel input to either channel output
- 4 × 2 switch matrix with integrated switch control - Tone/Voltage  
- Switch's Enable/Disable function is linked with POLA input voltage level
- Switch's Enable condition :  $V_{POLA} > 9.5 \text{ V}$
- Frequency range :  $f = 250 \text{ MHz to } 2150 \text{ MHz}$
- High isolation :  $ISL_{D/U} = 33 \text{ dB TYP. @Worst mode}$
- Insertion loss :  $L_{INS} = 7 \text{ dB TYP. @ } Z_S = Z_L = 50 \Omega$
- Insertion loss flatness :  $\Delta L_{INS} = 1.0 \text{ dB TYP.}$
- 20-pin 4 × 4 mm square micro lead package ( 20-pin plastic QFN (0.5 mm pitch))

## APPLICATIONS

- DBS IF switching
- Multiswitch, Switch box
- 4 × 2 switching application for microwave signal

## ORDERING INFORMATION

Part Number	Order Number	Package	Marking	Supplying Form
μPD5753T7G-E1	μPD5753T7G-E1-A	20-pin plastic QFN (0.5 mm pitch) (Pb-Free)	D5753	<ul style="list-style-type: none"> <li>• Embossed tape 12 mm wide</li> <li>• Pin 6 to 10 face the perforation side of the tape</li> <li>• Qty 5 kpcs/reel</li> <li>• Dry packing specification (MSL 3 Equivalent)</li> </ul>

**Remark** To order evaluation samples, please contact your nearby sales office.

Part number for sample order: μPD5753T7G

### CAUTION

Observe precautions when handling because these devices are sensitive to electrostatic discharge.

**ABSOLUTE MAXIMUM RATINGS (T<sub>A</sub> = +25°C, unless otherwise specified)**

Parameter	Symbol	Ratings	Unit
Supply Voltage	V <sub>DD</sub>	+4.0	V
Logic mode Control Voltage (MO and M1)	V <sub>MO</sub> , V <sub>M1</sub>	+4.0	V
Power Dissipation <sup>Note</sup>	P <sub>D</sub>	325	mW
Storage Temperature	T <sub>stg</sub>	-55 to +125	°C
Operating Ambient Temperature	T <sub>A</sub>	-40 to +85	°C
Input Power	P <sub>in</sub>	+15	dBm
POLA Control Input Voltage (POLA1 and POLA2)	V <sub>POLA</sub>	+25	V
TONE Signal Input Voltage	V <sub>TONE</sub>	1	V <sub>p-p</sub>

Note: Mounted on double-sided copper-clad 50 × 50 × 0.51 mm laminates PWB, T<sub>A</sub> = +85°C

**RECOMMENDED OPERATING RANGE (T<sub>A</sub> = +25°C, unless otherwise specified)**

Parameter	Symbol	MIN.	TYP.	MAX.	Unit
Supply Voltage	V <sub>DD</sub>	+3.0	+3.3	+3.6	V
Operating Ambient Temperature	T <sub>A</sub>	-40	+25	+85	°C
POLA Control Input Voltage	V <sub>POLA</sub>	0	-	21	V
TONE Signal Frequency	f <sub>TONE</sub>	18	22	26	kHz
TONE Signal Input Voltage	V <sub>TONE</sub>	0.4	0.6	0.8	V <sub>p-p</sub>

**ELECTRICAL CHARACTERISTICS**

(T<sub>A</sub> = +25°C, V<sub>DD</sub> = +3.3 V, Z<sub>S</sub> = Z<sub>L</sub> = 50 Ω for each port, Worst mode, unless otherwise specified)

Parameter	Symbol	Test Conditions	MIN.	TYP.	MAX.	Unit
Supply Current	I <sub>DD</sub>	Non-RF, Non control Signal/Voltage	-	1.9	3.0	mA
Insertion Loss 1	L <sub>INS1</sub>	P <sub>in</sub> = 0 dBm, f = 0.95 GHz	-	6.5	8.5	dB
Insertion Loss 2	L <sub>INS2</sub>	P <sub>in</sub> = 0 dBm, f = 2.15 GHz	-	7.5	9.5	dB
Isolation D/U Ratio 2 <sup>Note</sup>	ISL <sub>D/U2</sub>	P <sub>in</sub> = 0 dBm, f = 2.15 GHz	28	33	-	dB
Output Return Loss 1	RL <sub>out1</sub>	P <sub>in</sub> = 0 dBm, f = 0.95 GHz	15	25	-	dB
Output Return Loss 2	RL <sub>out2</sub>	P <sub>in</sub> = 0 dBm, f = 2.15 GHz	10	13	-	dB
POLA Control Threshold Voltage, Channel Selection	V <sub>th_POLA</sub>	OFF to ON	14	14.75	15.5	V
TONE Signal Threshold Voltage, Channel Selection	V <sub>th_TONE</sub>	f <sub>TONE</sub> = 22 kHz, Duty Cycle = 50%, pulse wave, OFF to ON	0.1	0.15	0.35	V <sub>p-p</sub>

Note: Isolation D/U (Desire/U<sub>n</sub>-desire) ratio = |(Signal Leakage (off-state)) - (Insertion loss (on-state))| at Worst mode

**STANDARD CHARACTERISTICS FOR REFERENCE**

( $T_A = +25^\circ\text{C}$ ,  $V_{DD} = +3.3\text{ V}$ ,  $Z_S = Z_L = 50\ \Omega$  for each port, Worst mode, unless otherwise specified)

Parameter	Symbol	Test Conditions	Reference Value	Unit
Insertion Loss Flatness	$\Delta L_{INS}$	$ L_{INS1} - L_{INS2} $	1.0	dB
Isolation D/U Ratio 1 <sup>Note</sup>	ISL <sub>D/U1</sub>	$P_{in} = 0\text{ dBm}$ , $f = 0.95\text{ GHz}$	40	dB
Input Return Loss 1	RL <sub>in1</sub>	$P_{in} = 0\text{ dBm}$ , $f = 0.95\text{ GHz}$	20	dB
Input Return Loss 2	RL <sub>in2</sub>	$P_{in} = 0\text{ dBm}$ , $f = 2.15\text{ GHz}$	14	dB
POLA Control Current	I <sub>POLA</sub>	$V_{POLA} = 21\text{ V}$	230	μA
POLA Switching Time	T <sub>POLA</sub>	$V_{POLA} = 18\text{ V}$ , OFF to ON	0.75	μs
TONE Switching Time	T <sub>TONE</sub>	$f_{TONE} = 22\text{ kHz}$ , Duty Cycle = 50%, pulse wave, $V_{TONE} = 600\text{ mV}_{p-p}$ , OFF to ON	220	μs

Note: Isolation D/U (Desire/Un-desire) ratio = |(Signal Leakage (off-state)) – (Insertion loss (on-state))| at Worst mode

## PIN CONNECTIONS

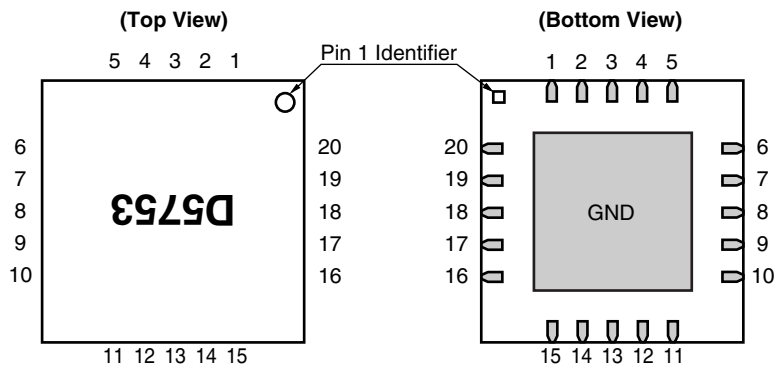

Pin No.	Pin Name	Pin No.	Pin Name	Pin No.	Pin Name	Pin No.	Pin Name
1	TONE1	6	IN-B	11	GND	16	OUT2
2	POLA1	7	GND	12	IN-C	17	M1
3	GND	8	GND	13	GND	18	V <sub>DD</sub>
4	IN-A	9	GND	14	POLA2	19	M0
5	GND	10	IN-D	15	TONE2	20	OUT1

**Remark** Heat Sink (Bottom side) : GND

**TRUTH TABLE**

**SWITCHING CONTROL OF OUT1 SIGNAL PATH**

Logic Pattern Select		CONTROL PINS for OUT1		OUT1
M0	M1	POLA1	TONE1	Output Signal
0	0	No Voltage	22 kHz	None
		No Voltage	0	None
		Low	22 kHz	IN-C
		Low	0	IN-D
		High	0	IN-B
		High	22 kHz	IN-A
1	1	No Voltage	22 kHz	None
		No Voltage	0	None
		Low	22 kHz	IN-A
		Low	0	IN-B
		High	0	IN-D
		High	22 kHz	IN-C
0	1	No Voltage	22 kHz	None
		No Voltage	0	None
		Low	22 kHz	IN-D
		Low	0	IN-C
		High	0	IN-B
		High	22 kHz	IN-A
1	0	No Voltage	22 kHz	None
		No Voltage	0	None
		Low	22 kHz	IN-B
		Low	0	IN-A
		High	0	IN-D
		High	22 kHz	IN-C

**SWITCHING CONTROL OF OUT2 SIGNAL PATH**

Logic Pattern Select		CONTROL PINS for OUT2		OUT2
M0	M1	POLA2	TONE2	Output Signal
0	0	No Voltage	22 kHz	None
		No Voltage	0	None
		Low	22 kHz	IN-C
		Low	0	IN-D
		High	0	IN-B
		High	22 kHz	IN-A
1	1	No Voltage	22 kHz	None
		No Voltage	0	None
		Low	22 kHz	IN-A
		Low	0	IN-B
		High	0	IN-D
		High	22 kHz	IN-C
0	1	No Voltage	22 kHz	None
		No Voltage	0	None
		Low	22 kHz	IN-D
		Low	0	IN-C
		High	0	IN-B
		High	22 kHz	IN-A
1	0	No Voltage	22 kHz	None
		No Voltage	0	None
		Low	22 kHz	IN-B
		Low	0	IN-A
		High	0	IN-D
		High	22 kHz	IN-C

**Remarks** M0, M1 : "0" : 0 V dc (Connected to GND line)  
 "1" : V<sub>DD</sub> dc (Connected to V<sub>DD</sub> line)

V<sub>DD</sub> = + 3.3 V dc

POLA1, 2 : "Low" : 9.5 V to 14 V dc  
 "High" : 15.5 V to 19 V dc

"No Voltage" : 0 V dc (< 5 V dc) or Open

Switch's Enable/Disable function is linked with POLA input voltage level

Switch's Enable condition : V<sub>POLA</sub> > 9.5 V

# FUNCTIONAL DIAGRAM

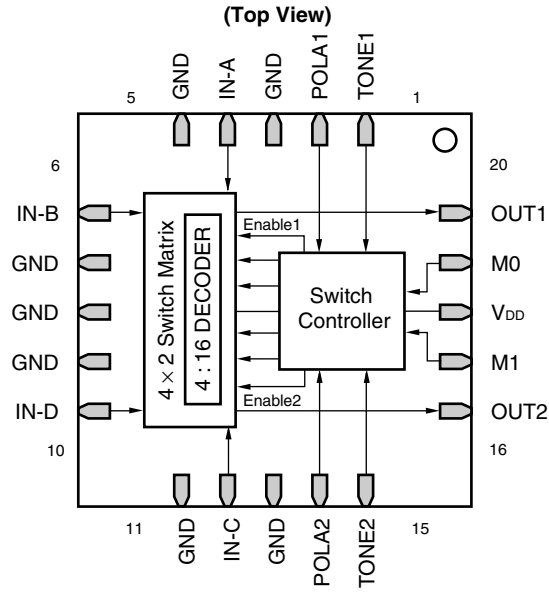

## EVALUATION CIRCUIT

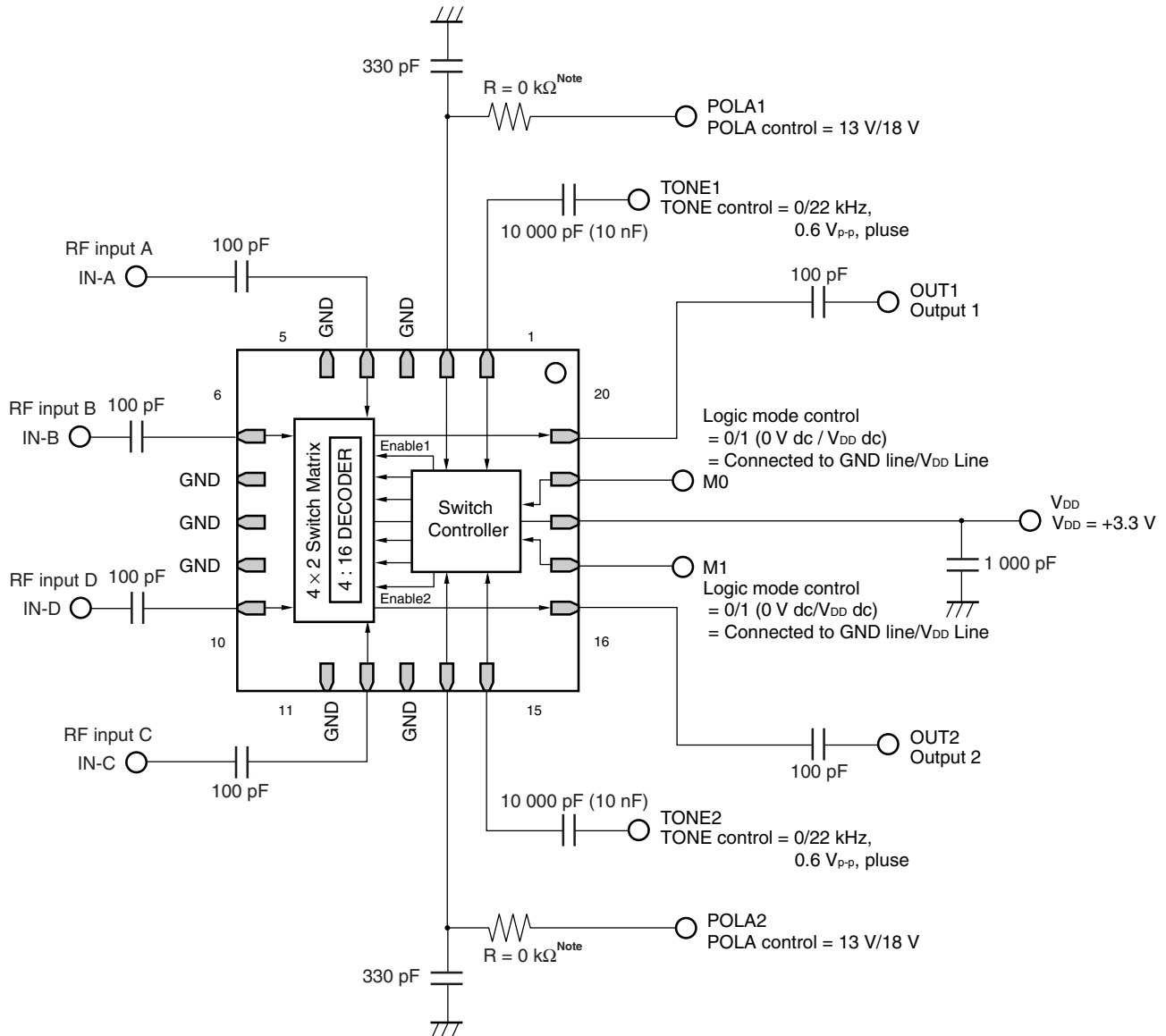

Note: R = 0 kΩ (at POLA control = 13 V/18 V)  
 = 5.6 kΩ (at POLA control = 14 V/18 V)

**Remarks** Heat Sink (Bottom Side): GND

$Z_S = Z_L = 50 \Omega$

Switch's Enable/Disable function is linked with POLA input voltage level

Switch's Enable condition :  $V_{POLA} > 9.5 \text{ V}$

The application circuits and their parameters are for reference only and are not intended for use in actual design-ins.

### TYPICAL CHARACTERISTICS

( $T_A = +25^\circ\text{C}$ ,  $V_{DD} = +3.3\text{ V}$ ,  $P_{in} = 0\text{ dBm}$ ,  $Z_S = Z_L = 50\ \Omega$  for each port, unless otherwise specified)

INSERTION LOSS vs. FREQUENCY  
(IN-x - OUT1)

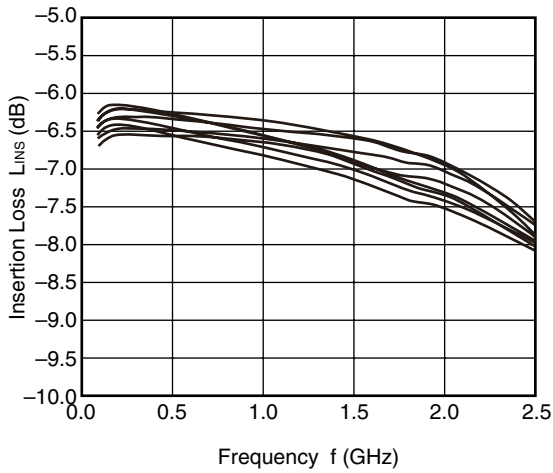

INSERTION LOSS vs. FREQUENCY  
(IN-x - OUT2)

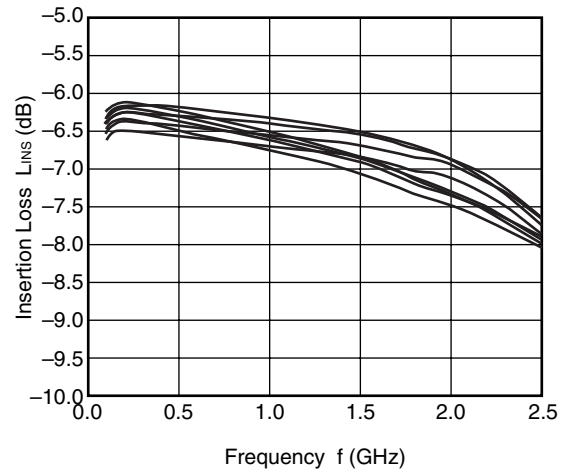

ISOLATION D/U RATIO vs. FREQUENCY  
(IN-A - OUT1)

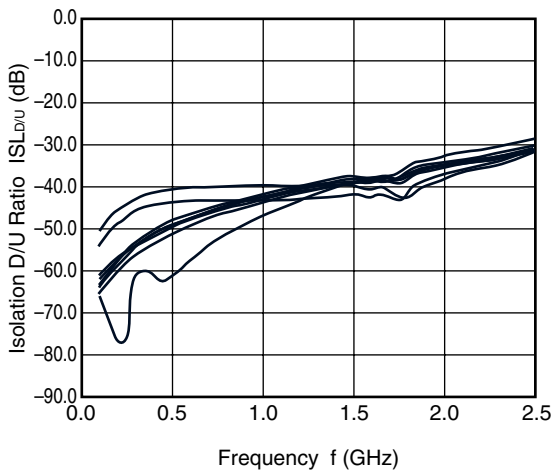

ISOLATION D/U RATIO vs. FREQUENCY  
(IN-B - OUT1)

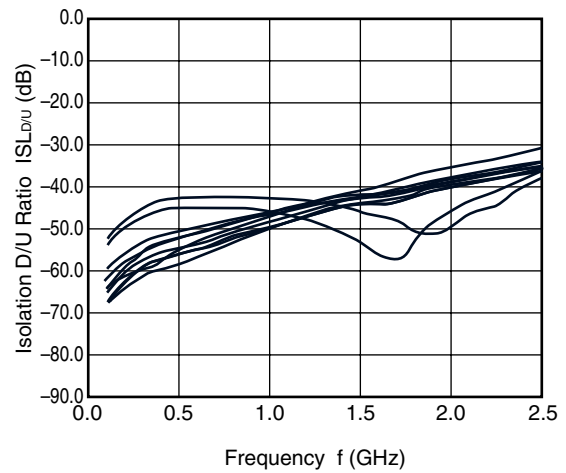

ISOLATION D/U RATIO vs. FREQUENCY  
(IN-C - OUT1)

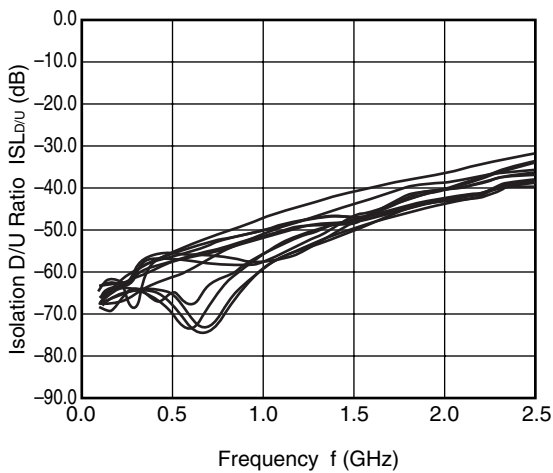

ISOLATION D/U RATIO vs. FREQUENCY  
(IN-D - OUT1)

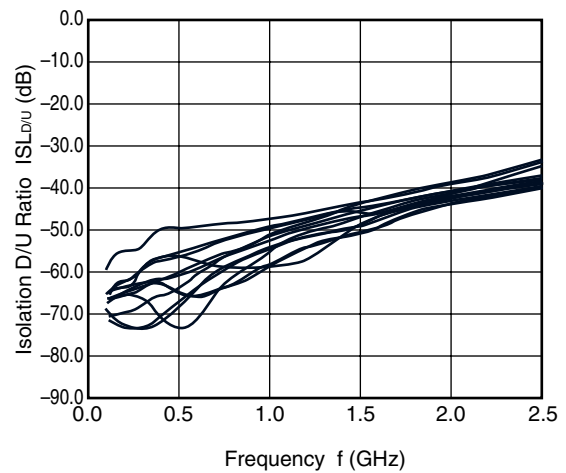

**Remark** The graphs indicate nominal characteristics.



ISOLATION D/U RATIO vs. FREQUENCY  
(IN-A - OUT2)

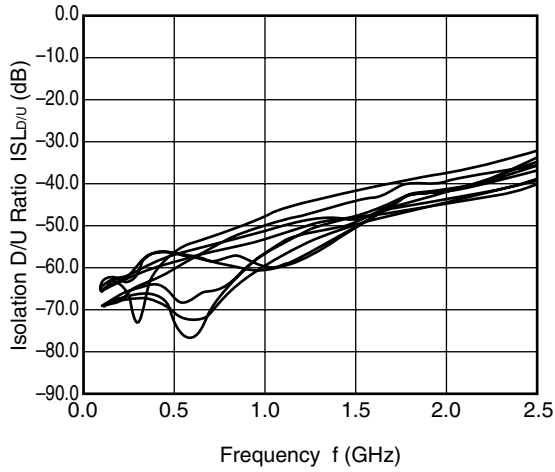

ISOLATION D/U RATIO vs. FREQUENCY  
(IN-B - OUT2)

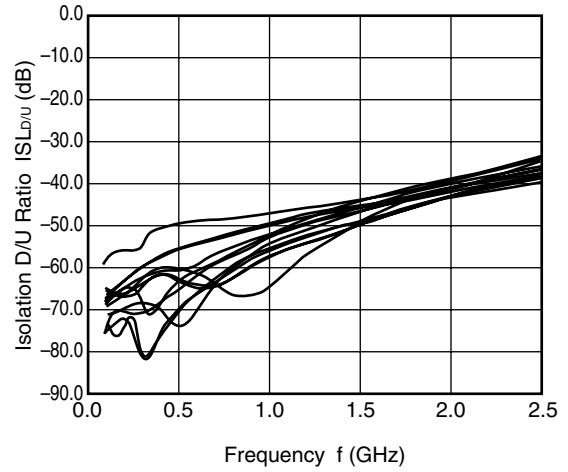

ISOLATION D/U RATIO vs. FREQUENCY  
(IN-C - OUT2)

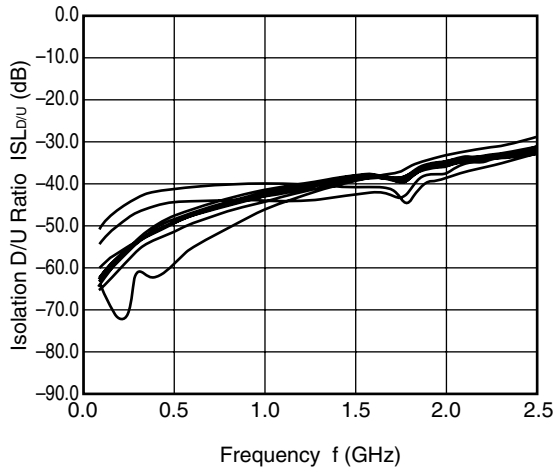

ISOLATION D/U RATIO vs. FREQUENCY  
(IN-D - OUT2)

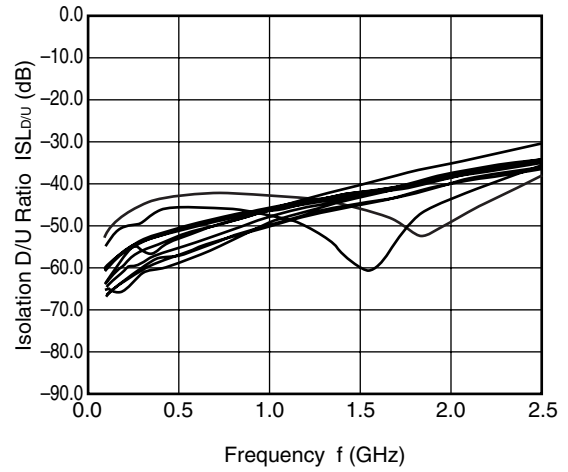

OUTPUT RETURN LOSS vs. FREQUENCY  
(IN-x - OUT1)

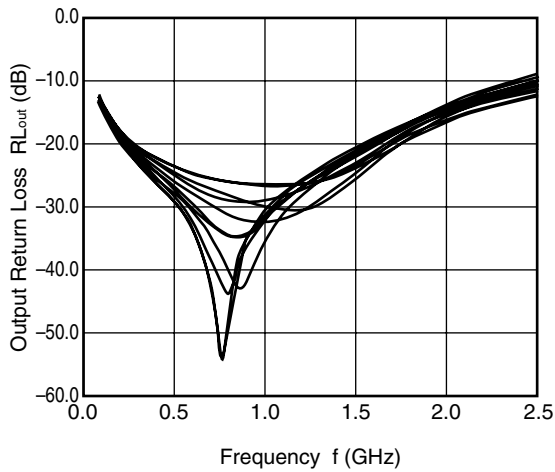

OUTPUT RETURN LOSS vs. FREQUENCY  
(IN-x - OUT2)

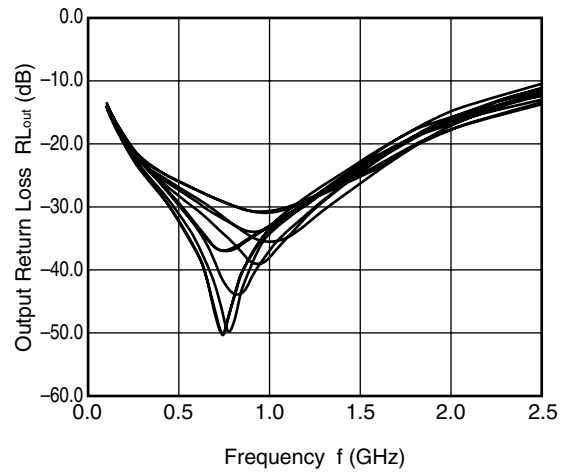

**Remark** The graphs indicate nominal characteristics.

INPUT RETURN LOSS vs. FREQUENCY  
(IN-A - OUTx)

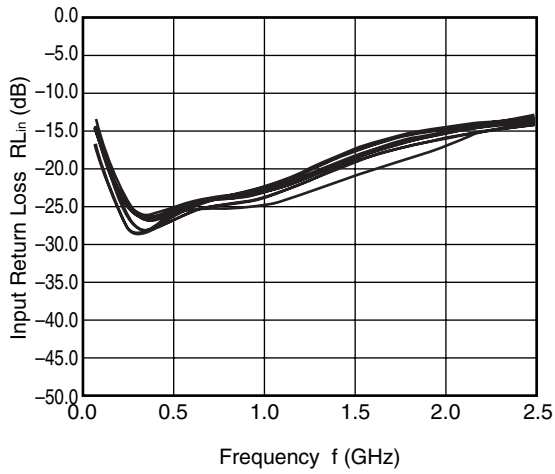

INPUT RETURN LOSS vs. FREQUENCY  
(IN-B - OUTx)

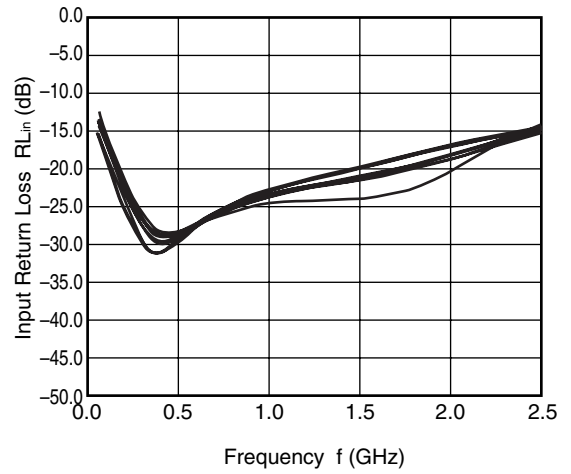

INPUT RETURN LOSS vs. FREQUENCY  
(IN-C - OUTx)

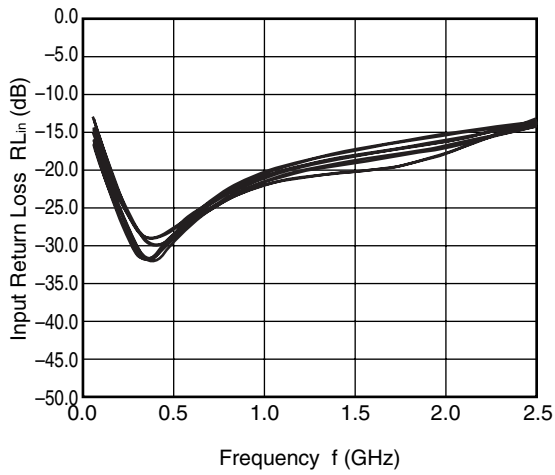

INPUT RETURN LOSS vs. FREQUENCY  
(IN-D - OUTx)

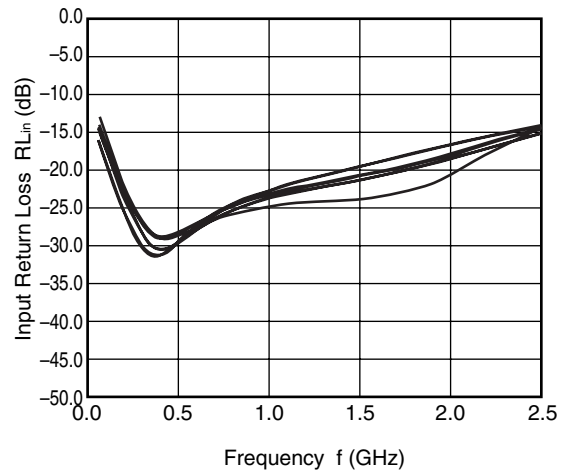

**Remark** The graphs indicate nominal characteristics.

## MOUNTING PAD LAYOUT DIMENSIONS

20-PIN 4 × 4 mm SQUARE MICRO LEAD PACKAGE (20-PIN PLASTIC QFN (0.5 mm pitch)) (UNIT: mm)

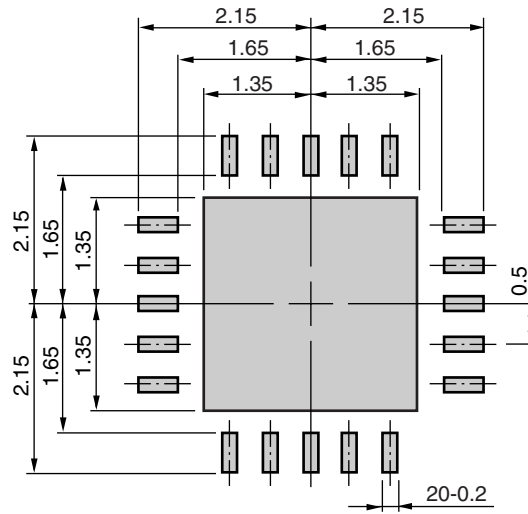

**Remark** The mounting pad layout in this document is for reference only.

## PACKAGE DIMENSIONS

20-PIN 4 × 4 mm SQUARE MICRO LEAD PACKAGE (20-PIN PLASTIC QFN (0.5 mm pitch)) (UNIT: mm)

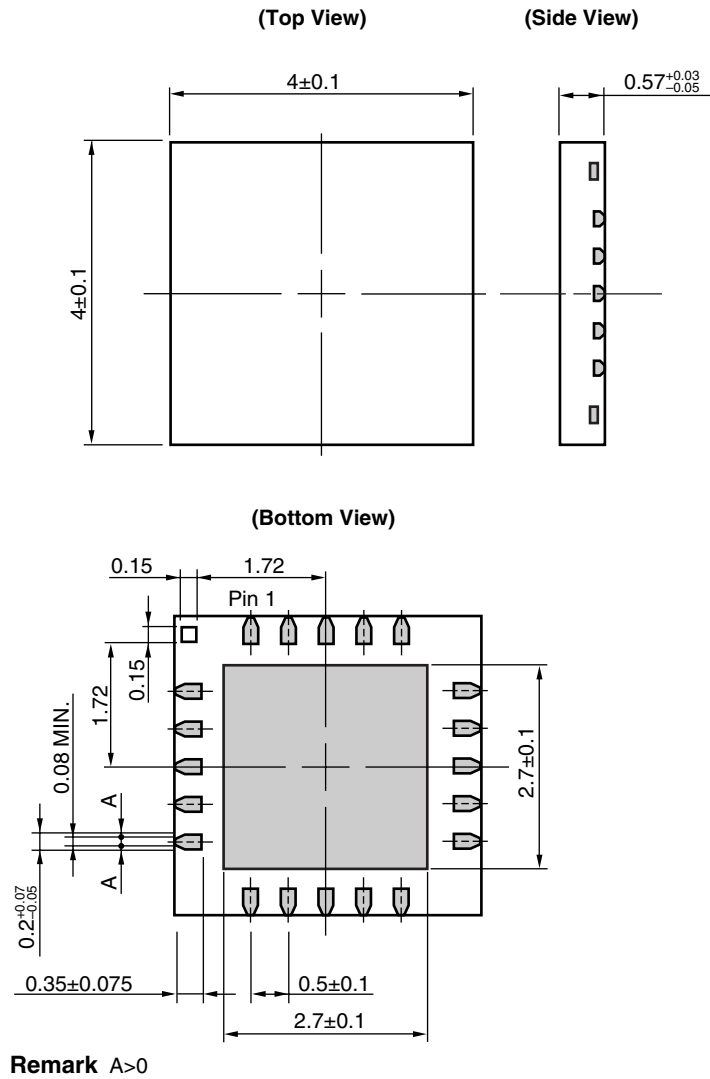

## RECOMMENDED SOLDERING CONDITIONS

This product should be soldered and mounted under the following recommended conditions. For soldering methods and conditions other than those recommended below, contact your nearby sales office.

Soldering Method	Soldering Conditions	Condition Symbol
Infrared Reflow	Peak temperature (package surface temperature) : 260°C or below Time at peak temperature : 10 seconds or less Time at temperature of 220°C or higher : 60 seconds or less Preheating time at 120 to 180°C : 120±30 seconds Maximum number of reflow processes : 3 times Maximum chlorine content of rosin flux (% mass) : 0.2%(Wt.) or below	IR260
Partial Heating	Peak temperature (package surface temperature) : 350°C or below Soldering time (per side of device) : 3 seconds or less Maximum chlorine content of rosin flux (% mass) : 0.2%(Wt.) or below	HS350

### CAUTION

Do not use different soldering methods together (except for partial heating).

<b>Revision History</b>	<b>μPD5753T7G Data Sheet</b>
-------------------------	------------------------------

<b>Rev.</b>	<b>Date</b>	<b>Description</b>	
		<b>Page</b>	<b>Summary</b>
1.00	Feb 22, 2011	–	First edition issued

All trademarks and registered trademarks are the property of their respective owners.

## Notice

- All information included in this document is current as of the date this document is issued. Such information, however, is subject to change without any prior notice. Before purchasing or using any Renesas Electronics products listed herein, please confirm the latest product information with a Renesas Electronics sales office. Also, please pay regular and careful attention to additional and different information to be disclosed by Renesas Electronics such as that disclosed through our website.
- Renesas Electronics does not assume any liability for infringement of patents, copyrights, or other intellectual property rights of third parties by or arising from the use of Renesas Electronics products or technical information described in this document. No license, express, implied or otherwise, is granted hereby under any patents, copyrights or other intellectual property rights of Renesas Electronics or others.
- You should not alter, modify, copy, or otherwise misappropriate any Renesas Electronics product, whether in whole or in part.
- Descriptions of circuits, software and other related information in this document are provided only to illustrate the operation of semiconductor products and application examples. You are fully responsible for the incorporation of these circuits, software, and information in the design of your equipment. Renesas Electronics assumes no responsibility for any losses incurred by you or third parties arising from the use of these circuits, software, or information.
- When exporting the products or technology described in this document, you should comply with the applicable export control laws and regulations and follow the procedures required by such laws and regulations. You should not use Renesas Electronics products or the technology described in this document for any purpose relating to military applications or use by the military, including but not limited to the development of weapons of mass destruction. Renesas Electronics products and technology may not be used for or incorporated into any products or systems whose manufacture, use, or sale is prohibited under any applicable domestic or foreign laws or regulations.
- Renesas Electronics has used reasonable care in preparing the information included in this document, but Renesas Electronics does not warrant that such information is error free. Renesas Electronics assumes no liability whatsoever for any damages incurred by you resulting from errors in or omissions from the information included herein.
- Renesas Electronics products are classified according to the following three quality grades: "Standard", "High Quality", and "Specific". The recommended applications for each Renesas Electronics product depends on the product's quality grade, as indicated below. You must check the quality grade of each Renesas Electronics product before using it in a particular application. You may not use any Renesas Electronics product for any application categorized as "Specific" without the prior written consent of Renesas Electronics. Further, you may not use any Renesas Electronics product for any application for which it is not intended without the prior written consent of Renesas Electronics. Renesas Electronics shall not be in any way liable for any damages or losses incurred by you or third parties arising from the use of any Renesas Electronics product for an application categorized as "Specific" or for which the product is not intended where you have failed to obtain the prior written consent of Renesas Electronics. The quality grade of each Renesas Electronics product is "Standard" unless otherwise expressly specified in a Renesas Electronics data sheets or data books, etc.  
"Standard": Computers; office equipment; communications equipment; test and measurement equipment; audio and visual equipment; home electronic appliances; machine tools; personal electronic equipment; and industrial robots.  
"High Quality": Transportation equipment (automobiles, trains, ships, etc.); traffic control systems; anti-disaster systems; anti-crime systems; safety equipment; and medical equipment not specifically designed for life support.  
"Specific": Aircraft; aerospace equipment; submersible repeaters; nuclear reactor control systems; medical equipment or systems for life support (e.g. artificial life support devices or systems), surgical implantations, or healthcare intervention (e.g. excision, etc.), and any other applications or purposes that pose a direct threat to human life.
- You should use the Renesas Electronics products described in this document within the range specified by Renesas Electronics, especially with respect to the maximum rating, operating supply voltage range, movement power voltage range, heat radiation characteristics, installation and other product characteristics. Renesas Electronics shall have no liability for malfunctions or damages arising out of the use of Renesas Electronics products beyond such specified ranges.
- Although Renesas Electronics endeavors to improve the quality and reliability of its products, semiconductor products have specific characteristics such as the occurrence of failure at a certain rate and malfunctions under certain use conditions. Further, Renesas Electronics products are not subject to radiation resistance design. Please be sure to implement safety measures to guard them against the possibility of physical injury, and injury or damage caused by fire in the event of the failure of a Renesas Electronics product, such as safety design for hardware and software including but not limited to redundancy, fire control and malfunction prevention, appropriate treatment for aging degradation or any other appropriate measures. Because the evaluation of microcomputer software alone is very difficult, please evaluate the safety of the final products or system manufactured by you.
- Please contact a Renesas Electronics sales office for details as to environmental matters such as the environmental compatibility of each Renesas Electronics product. Please use Renesas Electronics products in compliance with all applicable laws and regulations that regulate the inclusion or use of controlled substances, including without limitation, the EU RoHS Directive. Renesas Electronics assumes no liability for damages or losses occurring as a result of your noncompliance with applicable laws and regulations.
- This document may not be reproduced or duplicated, in any form, in whole or in part, without prior written consent of Renesas Electronics.
- Please contact a Renesas Electronics sales office if you have any questions regarding the information contained in this document or Renesas Electronics products, or if you have any other inquiries.  
(Note 1) "Renesas Electronics" as used in this document means Renesas Electronics Corporation and also includes its majority-owned subsidiaries.  
(Note 2) "Renesas Electronics product(s)" means any product developed or manufactured by or for Renesas Electronics.



### SALES OFFICES

Renesas Electronics Corporation

<http://www.renesas.com>

Refer to "<http://www.renesas.com/>" for the latest and detailed information.

**Renesas Electronics America Inc.**  
2880 Scott Boulevard Santa Clara, CA 95050-2554, U.S.A.  
Tel: +1-408-586-6000, Fax: +1-408-586-6130

**Renesas Electronics Canada Limited**  
1101 Nicholson Road, Newmarket, Ontario L3Y 9C3, Canada  
Tel: +1-905-898-5441, Fax: +1-905-898-3220

**Renesas Electronics Europe Limited**  
Dukes Meadow, Millboard Road, Bourne End, Buckinghamshire, SL8 5FH, U.K  
Tel: +44-1628-585-100, Fax: +44-1628-585-900

**Renesas Electronics Europe GmbH**  
Arcadiastrasse 10, 40472 Düsseldorf, Germany  
Tel: +49-211-65030, Fax: +49-211-6503-1327

**Renesas Electronics (China) Co., Ltd.**  
7th Floor, Quantum Plaza, No.27 ZhiChunLu Haidian District, Beijing 100083, P.R.China  
Tel: +86-10-8235-1155, Fax: +86-10-8235-7679

**Renesas Electronics (Shanghai) Co., Ltd.**  
Unit 204, 205, AZIA Center, No.1233 Lujiazui Ring Rd., Pudong District, Shanghai 200120, China  
Tel: +86-21-5877-1818, Fax: +86-21-6887-7858 / -7898

**Renesas Electronics Hong Kong Limited**  
Unit 1601-1613, 16/F., Tower 2, Grand Century Place, 193 Prince Edward Road West, Mongkok, Kowloon, Hong Kong  
Tel: +852-2886-9318, Fax: +852 2886-9022/9044

**Renesas Electronics Taiwan Co., Ltd.**  
7F, No. 363 Fu Shing North Road Taipei, Taiwan  
Tel: +886-2-8175-9600, Fax: +886 2-8175-9670

**Renesas Electronics Singapore Pte. Ltd.**  
1 HarbourFront Avenue, #06-10, Keppel Bay Tower, Singapore 098632  
Tel: +65-6213-0200, Fax: +65-6276-8001

**Renesas Electronics Malaysia Sdn.Bhd.**  
Unit 906, Block B, Menara Amcorp, Amcorp Trade Centre, No. 18, Jin Persiaran Barat, 46050 Petaling Jaya, Selangor Darul Ehsan, Malaysia  
Tel: +60-3-7955-9390, Fax: +60-3-7955-9510

**Renesas Electronics Korea Co., Ltd.**  
11F., Samik Lavied' or Bldg., 720-2 Yeoksam-Dong, Kangnam-Ku, Seoul 135-080, Korea  
Tel: +82-2-558-3737, Fax: +82-2-558-5141