

SERIES 34D
Sealed Sub-Miniature Toggle Switches

FEATURES

- Save Space and Weight
- SPDT and DPDT Circuitry
- Choice of Actuators, Bushings, and Terminations
- Sealed per IP67

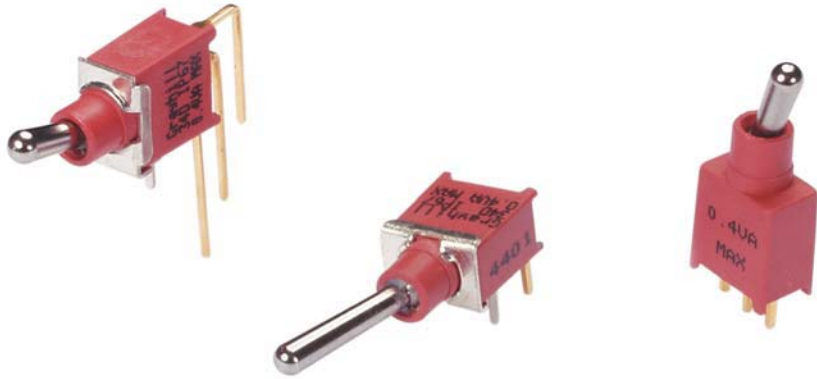

MODELS In inches (and millimeters)

SPDT

Model No.	Switching Position		
WMSP1	ON	NONE	ON
WMSP2	ON	NONE	(ON)
WMSP3	ON	OFF	ON
WMSP4	(ON)	OFF	(ON)
WMSP5	ON	OFF	(ON)
Term. Comm.	2-3	OPEN	2-1

()=MOMENTARY

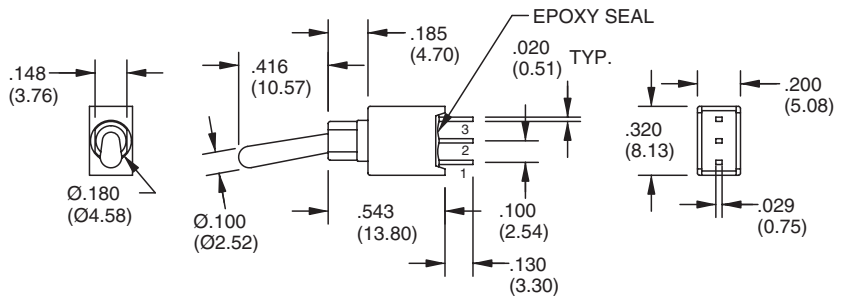

DPDT

Model No.	Switching Position		
WMDP1	ON	NONE	ON
WMDP2	ON	NONE	(ON)
WMDP3	ON	OFF	ON
WMDP4	(ON)	OFF	(ON)
WMDP5	ON	OFF	(ON)
Term. Comm.	2-3 5-6	OPEN	2-1 5-4

()=MOMENTARY

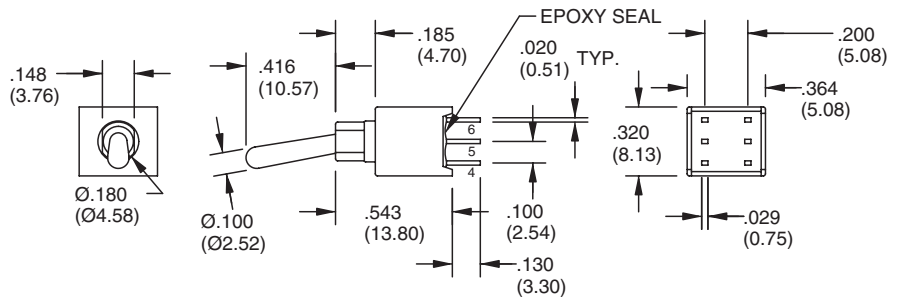
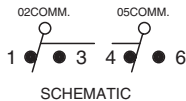

ACTUATOR OPTIONS In inches (and millimeters)

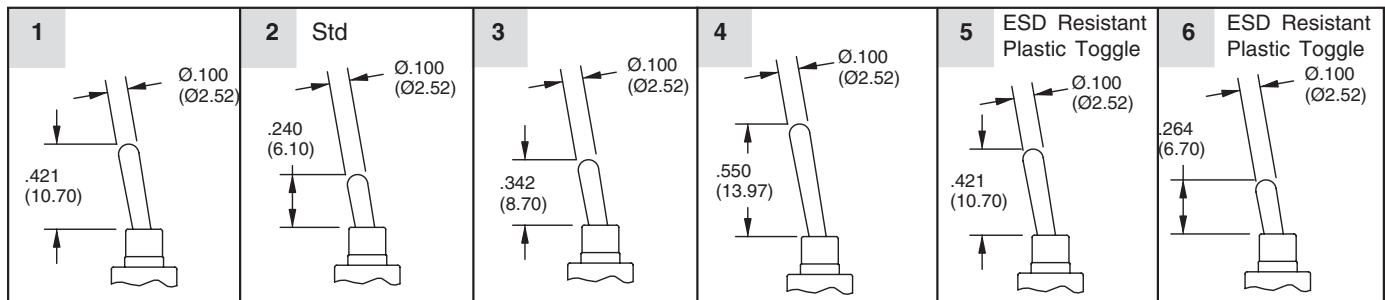

Toggle Switches

BUSHING OPTION In inches (and millimeters)

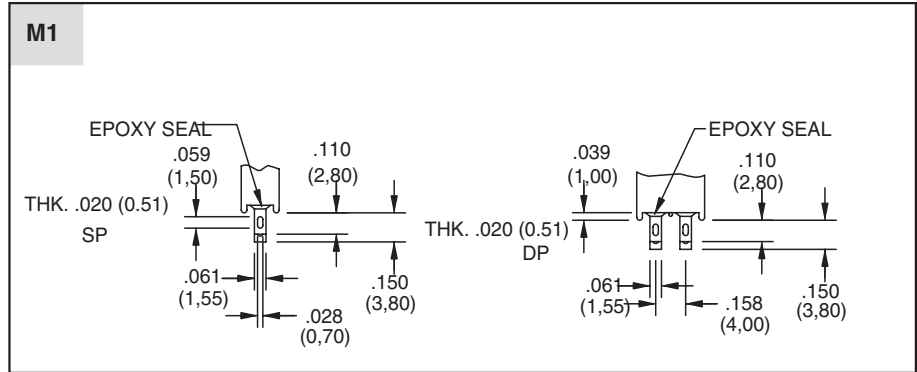
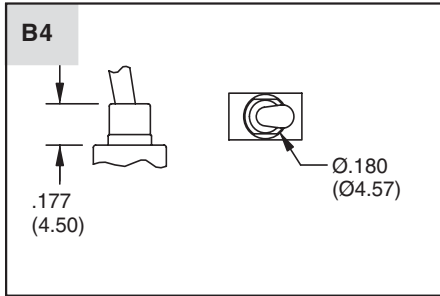

TERMINATION OPTIONS

In inches (and millimeters)

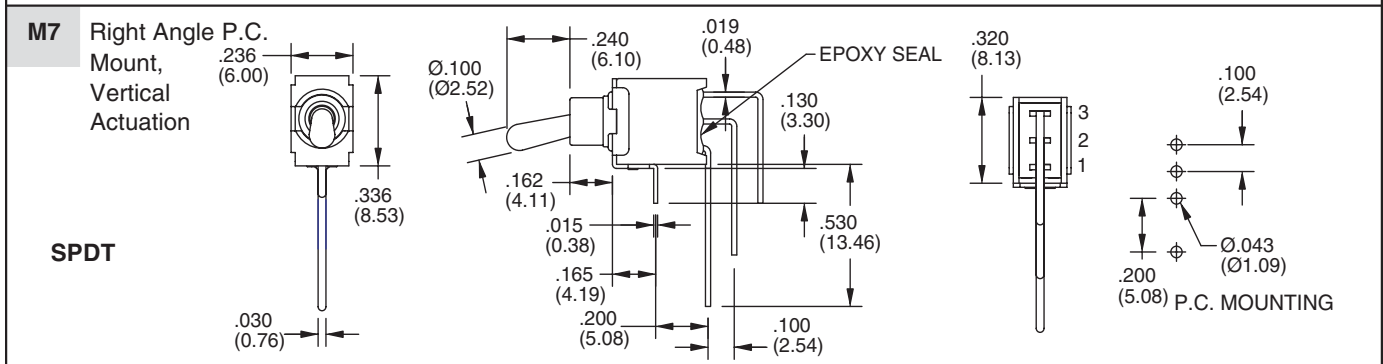
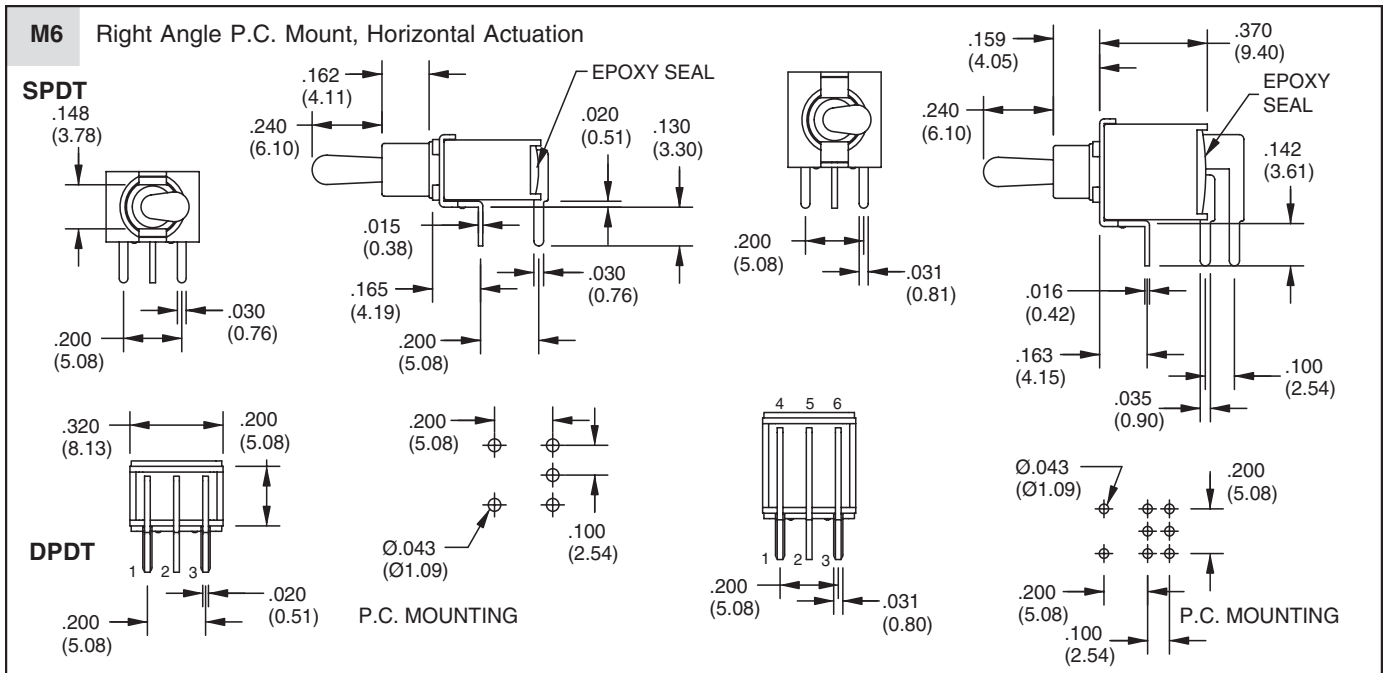
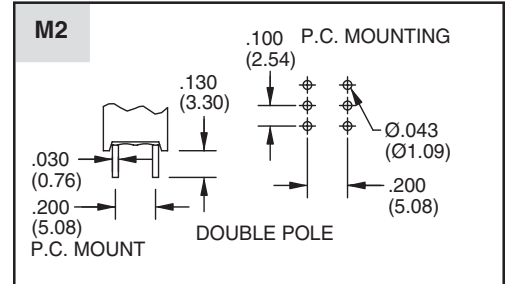
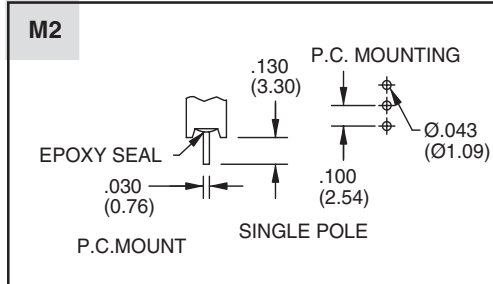

TERMINATION OPTIONS In inches (and millimeters)

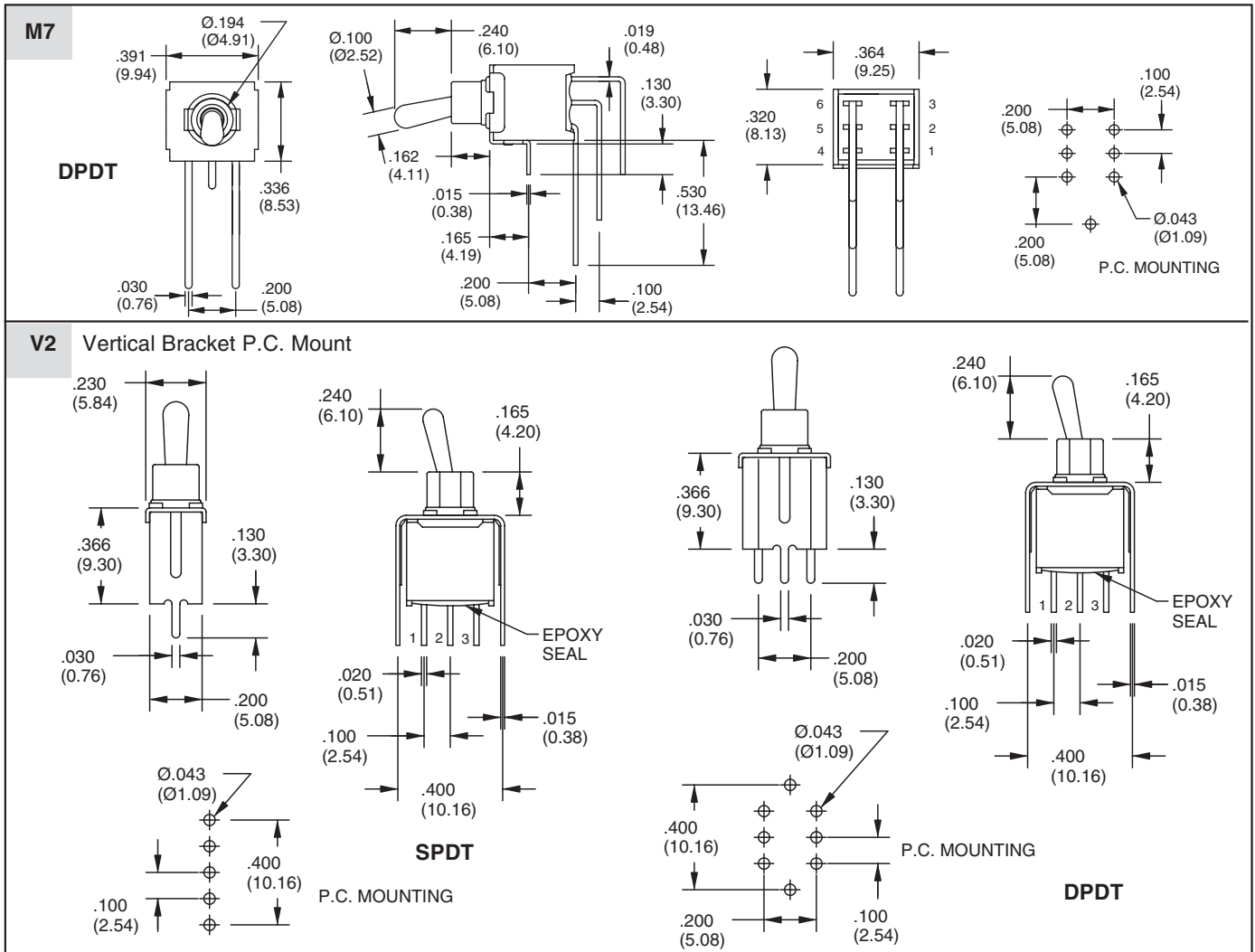

SPECIFICATIONS

RATINGS

Contact Rating: Q option - 3A with resistive load @ 125VAC or 28 VDC; 1.5A with resistive load @ 250 VAC. R option-0.4 VA max @ 20 Vmax (AC or DC)
Electrical Life: 30,000 make-and-break cycles at full load

Contact Resistance: 20 milliohms max. initial @ 2-4 VDC, 100 mA

Insulation Resistance: 1,000 megaohms minimum

Dielectric Strength: 1,500 V RMS @ sea level

Operating Temperature: -30°C to 85°C

MATERIALS

Case: Diallyl phthalate (DAP) (UL94V-0)
Toggle Handle: Brass, chrome plated
Bushing: Brass, nickel plated
Housing: Stainless steel
Terminal/Switch Support: Brass, electroplated
Contacts & Terminals: Copper alloy, gold plate over nickel plate or silver plate
Terminal Seal: Epoxy

ORDERING INFORMATION

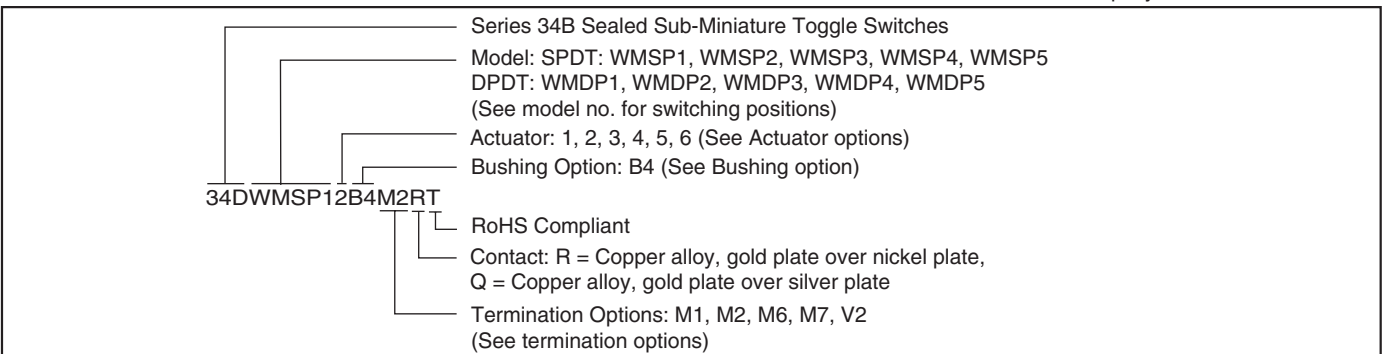

Available from your local Grayhill Component Distributor. For prices and discounts, contact a local Sales Office, an authorized local Distributor or Grayhill.

Toggle Switches