

## Ultrafast Rectifier, 8 A FRED Pt®

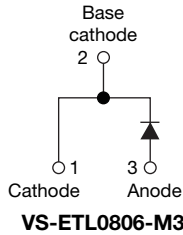

2L TO-220AC



2L TO-220 FULL-PAK

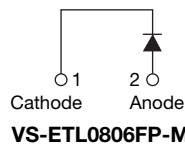

### FEATURES

- State of the art low forward voltage drop
- Ultrafast recovery time
- 175 °C operating junction temperature
- Low leakage current
- Fully isolated package ( $V_{INS} = 2500 V_{RMS}$ )
- True 2 pin package
- Compliant to RoHS Directive 2002/95/EC
- Halogen-free according to IEC 61249-2-21 definition
- Designed and qualified according to JEDEC-JESD47



**RoHS**  
COMPLIANT  
HALOGEN  
**FREE**

### DESCRIPTION

State of the art, ultralow  $V_F$ , soft-switching ultrafast rectifiers optimized for Discontinuous (Critical) Mode (DCM) Power Factor Correction (PFC).

The minimized conduction loss, optimized stored charge and low recovery current minimized the switching losses and reduce over dissipation in the switching element and snubbers.

The device is also intended for use as a freewheeling diode in power supplies and other power switching applications.

### APPLICATIONS

AC-DC SMPS 70 W to 400 W

e.g. laptop and printer AC adaptors, desktop PC, TV and monitor, games units and DVD AC/DC power supplies.

### PRODUCT SUMMARY

Package	2L TO-220AC, 2L TO-220FP
$I_{F(AV)}$	8 A
$V_R$	600 V
$V_F$ at $I_F$	1.1 V
$t_{rr}$ (typ.)	65 ns
$T_J$ max.	175 °C
Diode variation	Single die

### ABSOLUTE MAXIMUM RATINGS

PARAMETER	SYMBOL	TEST CONDITIONS	VALUES	UNITS
Peak repetitive reverse voltage	$V_{RRM}$		600	V
Average rectified forward current in DC	$I_{F(AV)}$	$T_C = 155\text{ °C}$	8	A
FULL-PAK		$T_C = 134\text{ °C}$		
Non-repetitive peak surge current	$I_{FSM}$	$T_J = 25\text{ °C}$	120	
Operating junction and storage temperatures	$T_J, T_{Stg}$		- 65 to 175	°C

### ELECTRICAL SPECIFICATIONS ( $T_J = 25\text{ °C}$ unless otherwise specified)

PARAMETER	SYMBOL	TEST CONDITIONS	MIN.	TYP.	MAX.	UNITS
Breakdown voltage, blocking voltage	$V_{BR}, V_R$	$I_R = 100\ \mu A$	600	-	-	V
Forward voltage	$V_F$	$I_F = 8\text{ A}$	-	0.97	1.07	
		$I_F = 8\text{ A}, T_J = 150\text{ °C}$	-	0.84	0.90	
Reverse leakage current	$I_R$	$V_R = V_R$ rated	-	0.01	9	$\mu A$
		$T_J = 150\text{ °C}, V_R = V_R$ rated	-	5	50	
Junction capacitance	$C_T$	$V_R = 600\text{ V}$	-	6	-	pF
Series inductance	$L_S$	Measured lead to lead 5 mm from package body	-	8	-	nH

# VS-ETL0806-M3, VS-ETL0806FP-M3



Vishay Semiconductors Ultrafast Rectifier, 8 A FRED Pt®

DYNAMIC RECOVERY CHARACTERISTICS ( $T_J = 25\text{ }^\circ\text{C}$ unless otherwise specified)						
PARAMETER	SYMBOL	TEST CONDITIONS	MIN.	TYP.	MAX.	UNITS
Reverse recovery time	$t_{rr}$	$I_F = 1\text{ A}$ , $di_F/dt = 100\text{ A}/\mu\text{s}$ , $V_R = 30\text{ V}$	-	65	100	ns
		$I_F = 8\text{ A}$ , $di_F/dt = 100\text{ A}/\mu\text{s}$ , $V_R = 30\text{ V}$	-	150	250	
		$T_J = 25\text{ }^\circ\text{C}$	-	180	-	
		$T_J = 125\text{ }^\circ\text{C}$	-	240	-	
Peak recovery current	$I_{RRM}$	$T_J = 25\text{ }^\circ\text{C}$	-	15	-	A
		$T_J = 125\text{ }^\circ\text{C}$	-	19	-	
Reverse recovery charge	$Q_{rr}$	$T_J = 25\text{ }^\circ\text{C}$	-	1500	-	nC
		$T_J = 125\text{ }^\circ\text{C}$	-	2400	-	

THERMAL - MECHANICAL SPECIFICATIONS						
PARAMETER	SYMBOL	TEST CONDITIONS	MIN.	TYP.	MAX.	UNITS
Maximum junction and storage temperature range	$T_J$ , $T_{Stg}$		- 65	-	175	$^\circ\text{C}$
Thermal resistance, junction to case	$R_{thJC}$		-	2.0	2.6	$^\circ\text{C}/\text{W}$
		FULL-PAK	-	4.6	5.5	
Thermal resistance, junction to ambient	$R_{thJA}$	Typical socket mount	-	-	70	
Typical thermal resistance, case to heatsink	$R_{thCS}$	Mounting surface, flat, smooth and greased	-	0.5	-	
Weight			-	2	-	g
			-	0.07	-	oz.
Mounting torque			6 (5)	-	12 (10)	kgf · cm (lb · in)
			Case style 2L TO-220AC	ETL0806		
Marking device		Case style 2L TO-220 FULL-PAK	ETL0806FP			



# VS-ETL0806-M3, VS-ETL0806FP-M3

Ultrafast Rectifier, 8 A FRED Pt<sup>®</sup> Vishay Semiconductors

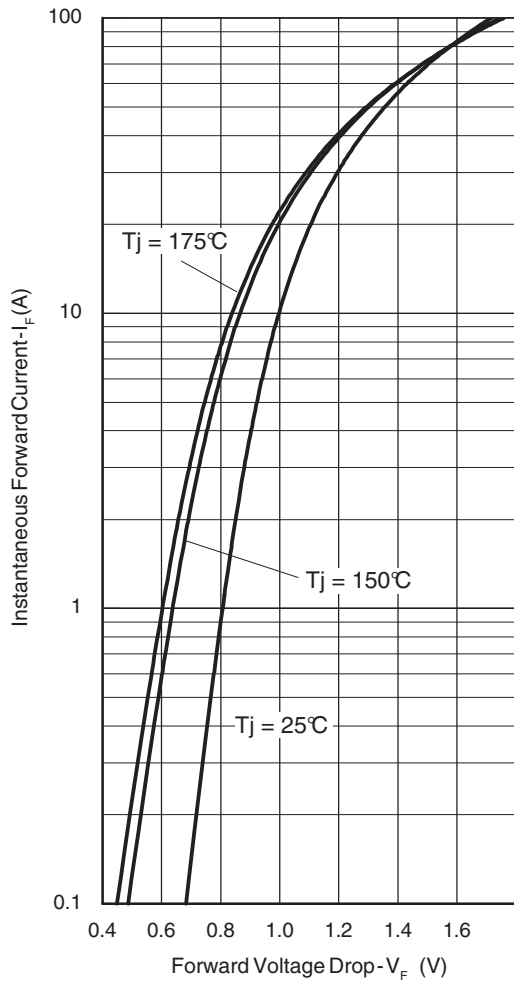

Fig. 1 - Typical Forward Voltage Drop Characteristics

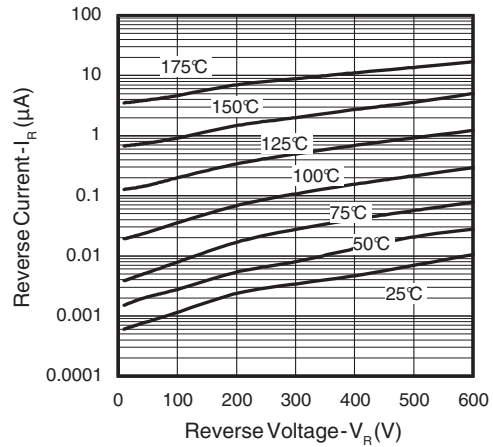

Fig. 2 - Typical Values of Reverse Current vs. Reverse Voltage

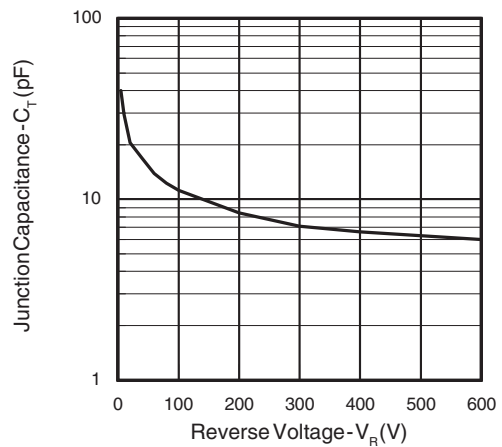

Fig. 3 - Typical Junction Capacitance vs. Reverse Voltage

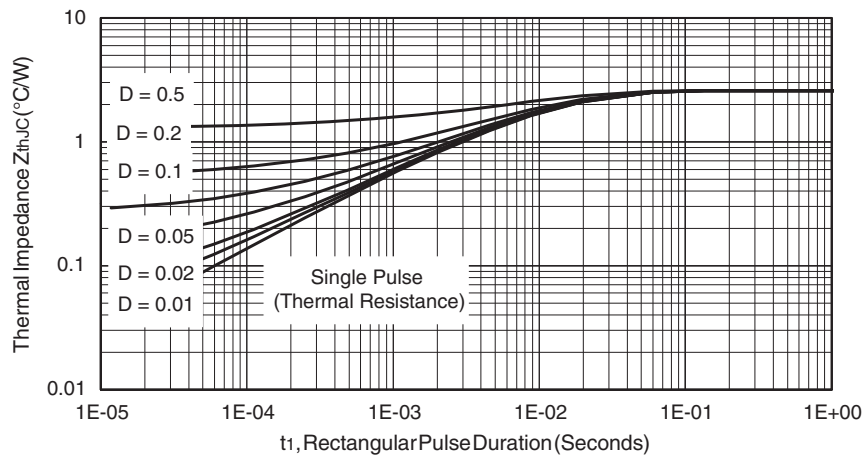

Fig. 4 - Maximum Thermal Impedance  $Z_{thJC}$  Characteristics

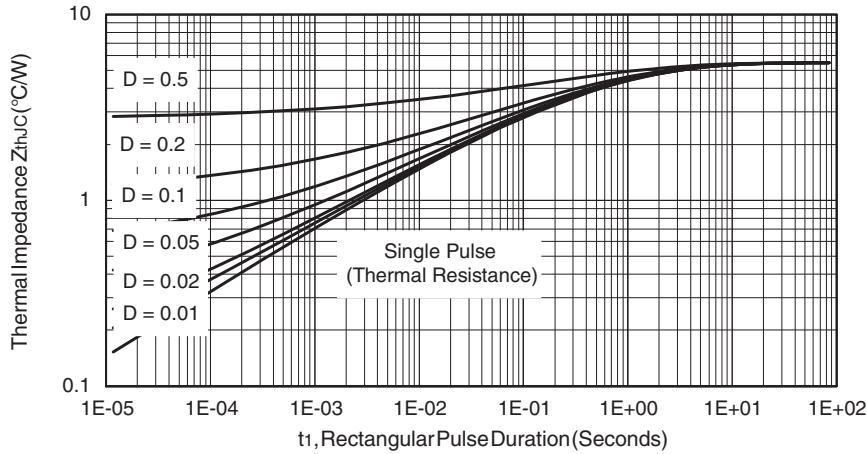

Fig. 5 - Maximum Thermal Impedance  $Z_{thJC}$  Characteristics (FULL-PAK)

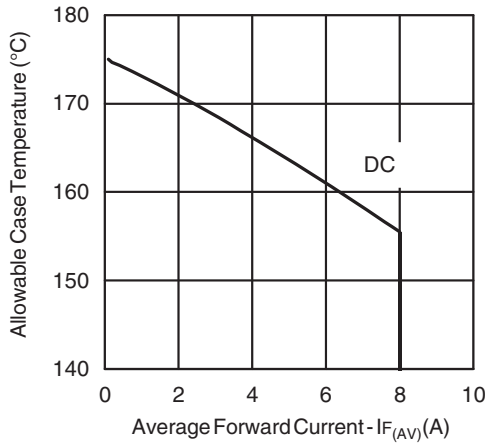

Fig. 6 - Maximum Allowable Case Temperature vs. Average Forward Current

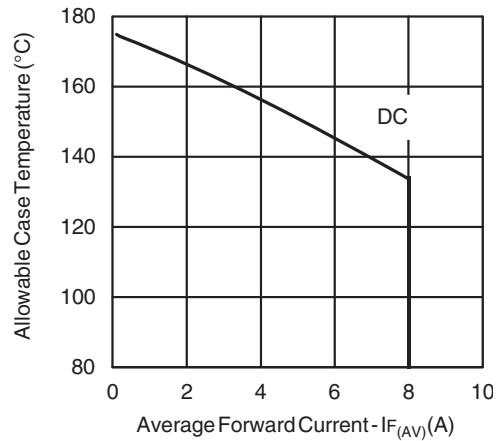

Fig. 7 - Maximum Allowable Case Temperature vs. Average Forward Current (FULL-PAK)

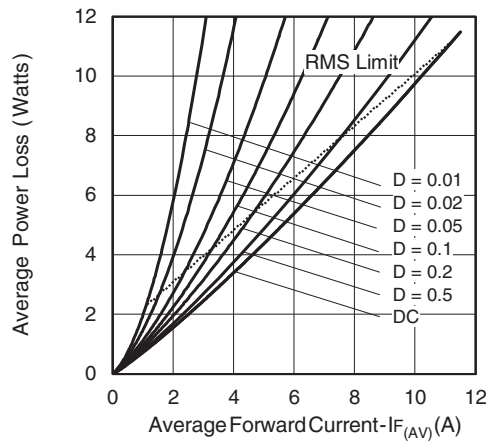

Fig. 8 - Forward Power Loss Characteristics

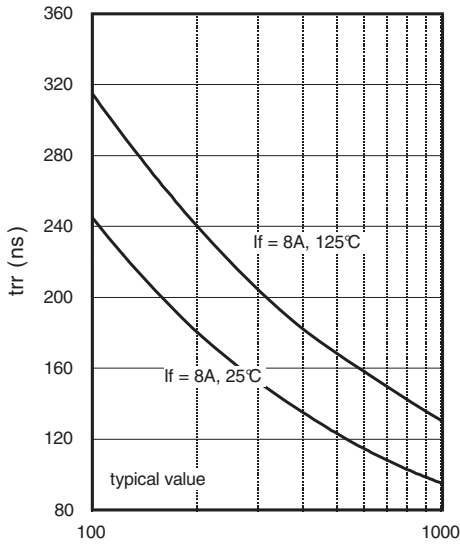

Fig. 9 - Typical Reverse Recovery vs.  $di_F/dt$

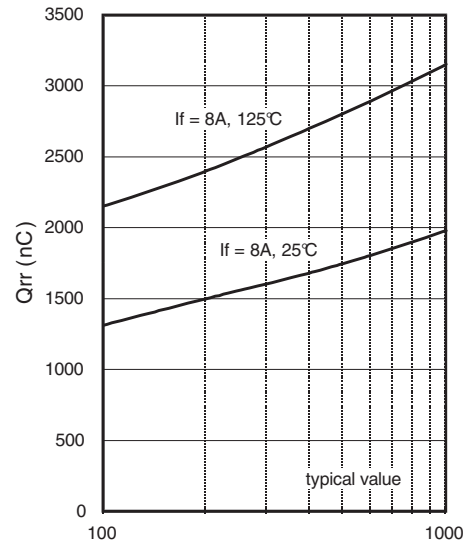

Fig. 10 - Typical Stored Charge vs.  $di_F/dt$

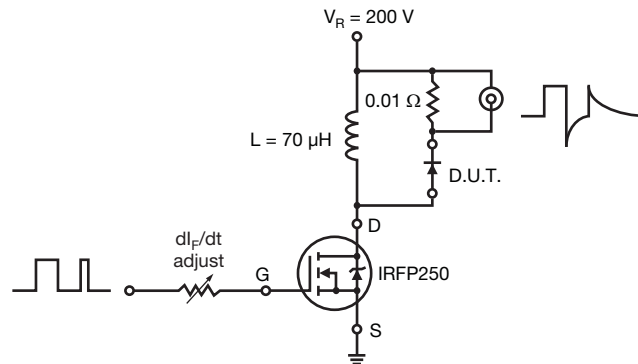
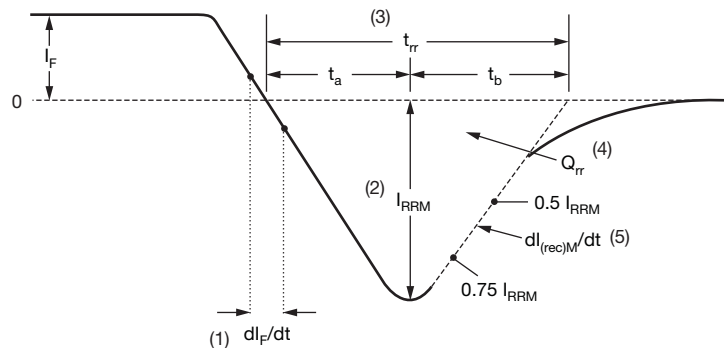

Fig. 11 - Reverse Recovery Parameter Test Circuit



- (1)  $di_F/dt$  - rate of change of current through zero crossing
- (2)  $I_{RRM}$  - peak reverse recovery current
- (3)  $t_{rr}$  - reverse recovery time measured from zero crossing point of negative going  $I_F$  to point where a line passing through  $0.75 I_{RRM}$  and  $0.50 I_{RRM}$  extrapolated to zero current.
- (4)  $Q_{rr}$  - area under curve defined by  $t_{rr}$  and  $I_{RRM}$
- (5)  $dl_{(rec)M}/dt$  - peak rate of change of current during  $t_b$  portion of  $t_{rr}$

$$Q_{rr} = \frac{t_{rr} \times I_{RRM}}{2}$$

Fig. 12 - Reverse Recovery Waveform and Definitions

# VS-ETL0806-M3, VS-ETL0806FP-M3

Vishay Semiconductors Ultrafast Rectifier, 8 A FRED Pt®



## ORDERING INFORMATION TABLE

Device code	<b>VS-</b>	<b>E</b>	<b>T</b>	<b>L</b>	<b>08</b>	<b>06</b>	<b>FP</b>	<b>-M3</b>
	①	②	③	④	⑤	⑥	⑦	⑧

- 1** - Vishay Semiconductors product
- 2** - Circuit configuration:  
E = Single diode
- 3** - T = TO-220
- 4** - L = Hyperfast recovery time
- 5** - Current code: 08 = 80 A
- 6** - Voltage code: 06 = 600 V
- 7** -
  - None = TO-220
  - FP = FULL-PAK
- 8** - Environmental digit:  
-M3 = Halogen-free, RoHS compliant and terminations lead (Pb)-free

ORDERING INFORMATION (Example)			
PREFERRED P/N	QUANTITY PER TUBE	MINIMUM ORDER QUANTITY	PACKAGING DESCRIPTION
VS-ETL0806-M3	50	1000	Antistatic plastic tube
VS-ETL0806FP-M3	50	1000	Antistatic plastic tube

LINKS TO RELATED DOCUMENTS			
Dimensions	2L TO-220AC	<a href="http://www.vishay.com/doc?95259">www.vishay.com/doc?95259</a>	
	2L TO-220 FULL-PAK	<a href="http://www.vishay.com/doc?95260">www.vishay.com/doc?95260</a>	
Part marking information	2L TO-220AC	<a href="http://www.vishay.com/doc?95391">www.vishay.com/doc?95391</a>	
	2L TO-220 FULL-PAK	<a href="http://www.vishay.com/doc?95392">www.vishay.com/doc?95392</a>	



## Disclaimer

ALL PRODUCT, PRODUCT SPECIFICATIONS AND DATA ARE SUBJECT TO CHANGE WITHOUT NOTICE TO IMPROVE RELIABILITY, FUNCTION OR DESIGN OR OTHERWISE.

Vishay Intertechnology, Inc., its affiliates, agents, and employees, and all persons acting on its or their behalf (collectively, "Vishay"), disclaim any and all liability for any errors, inaccuracies or incompleteness contained in any datasheet or in any other disclosure relating to any product.

Vishay makes no warranty, representation or guarantee regarding the suitability of the products for any particular purpose or the continuing production of any product. To the maximum extent permitted by applicable law, Vishay disclaims (i) any and all liability arising out of the application or use of any product, (ii) any and all liability, including without limitation special, consequential or incidental damages, and (iii) any and all implied warranties, including warranties of fitness for particular purpose, non-infringement and merchantability.

Statements regarding the suitability of products for certain types of applications are based on Vishay's knowledge of typical requirements that are often placed on Vishay products in generic applications. Such statements are not binding statements about the suitability of products for a particular application. It is the customer's responsibility to validate that a particular product with the properties described in the product specification is suitable for use in a particular application. Parameters provided in datasheets and/or specifications may vary in different applications and performance may vary over time. All operating parameters, including typical parameters, must be validated for each customer application by the customer's technical experts. Product specifications do not expand or otherwise modify Vishay's terms and conditions of purchase, including but not limited to the warranty expressed therein.

Except as expressly indicated in writing, Vishay products are not designed for use in medical, life-saving, or life-sustaining applications or for any other application in which the failure of the Vishay product could result in personal injury or death. Customers using or selling Vishay products not expressly indicated for use in such applications do so at their own risk and agree to fully indemnify and hold Vishay and its distributors harmless from and against any and all claims, liabilities, expenses and damages arising or resulting in connection with such use or sale, including attorneys fees, even if such claim alleges that Vishay or its distributor was negligent regarding the design or manufacture of the part. Please contact authorized Vishay personnel to obtain written terms and conditions regarding products designed for such applications.

No license, express or implied, by estoppel or otherwise, to any intellectual property rights is granted by this document or by any conduct of Vishay. Product names and markings noted herein may be trademarks of their respective owners.