



ESDA6V1FUx

Application Specific Discretés
A.S.D.TM

ESD PROTECTION MONOLITHIC
9-BIT WIDE TRANSILTM ARRAY

MAIN APPLICATIONS

Where protection in ESD sensitive equipment is required, such as :

- Computers
- Printers
- Communication systems

DESCRIPTION

The ESDA6V1FUx is a monolithic TRANSIL array designed to provide a 9-bit wide undershoot and overshoot clamping function in association with ESD protection level of up to 25 kV.

The ESDA6V1FUx provides best efficiency when using separated inputs and outputs, in the so called 4-point structure.

FEATURES

- 9-bit wide undershoot and overshoot clamping functions.
- Breakdown voltage : $V_{BR} = 6.1V$ min.
- Forward voltage $V_F = 1.25V$ max. @ $I_F = 200mA$
- Low capacitance : $C = 130pF$ @ $V_{RM} = 5.25V$.
- Low clamping voltage.
- 200W peak pulse power (8/20 μs).

BENEFITS

- ESD protection of 25 kV, according to MIL STD- Method 3015-6.
- High integration.
- Four points structure, avoiding all ESD effects at the outputs.

COMPLIES WITH THE FOLLOWING STANDARDS :

- ESD standard :

. IEC 1000-4-2

Level 4	15kV	(air discharge)
	8kV	(contact discharge)

- MIL STD 883C - Method 3015-6

$V_P = 25 kV$	$C = 100 pF$	$R = 1500 \Omega$
---------------	--------------	-------------------

3 positive strikes and 3 negative strikes (F = 1 Hz)

- Human body test :

$V_P = 4 kV$	$C = 150 pF$	$R = 150 \Omega$
--------------	--------------	------------------

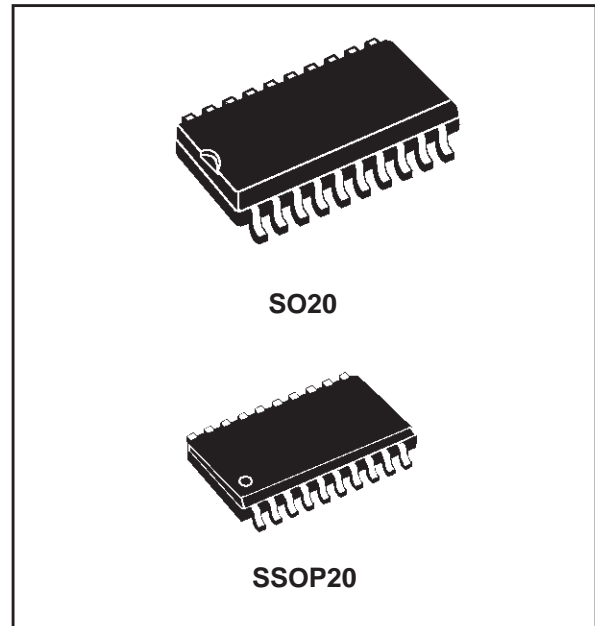

PIN-OUT CONFIGURATION

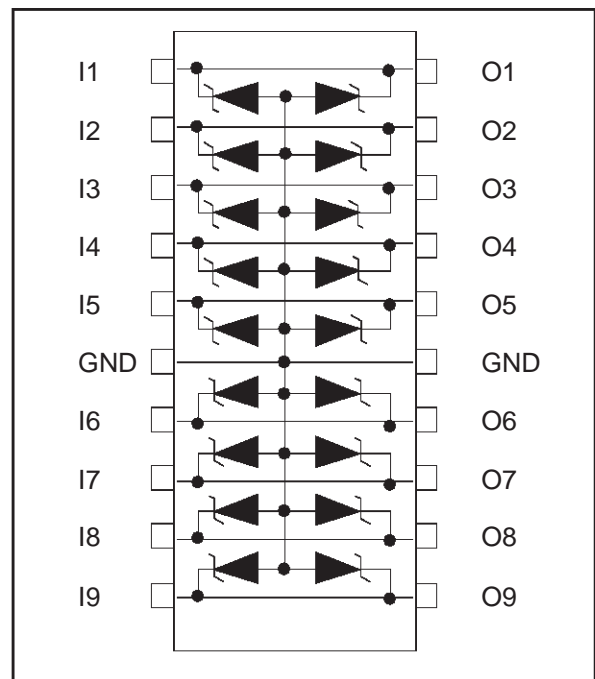

TRANSIL is a trademark of STMicroelectronics

November 1998 - Ed: 1

ABSOLUTE MAXIMUM RATINGS ($T_{amb} = 25^{\circ}\text{C}$)

Symbol	Parameter	Value	Unit
V_{PP}	Maximum electrostatic discharge in following measurement conditions: MIL STD 883C - METHOD 3015-6 IEC1000-4-2 - air discharge IEC1000-4-2 - contact discharge	25 16 9	kV
P_{PP}	Peak pulse power (8/20 μs)	200	W
T_{stg} T_j	Storage temperature Maximum junction temperature	- 55 to + 150 125	$^{\circ}\text{C}$ $^{\circ}\text{C}$

Symbol	Parameter
V_{RM}	Stand-off voltage
V_{BR}	Breakdown voltage
V_{CL}	Clamping voltage
V_F	Forward voltage drop
C	Capacitance
R_d	Dynamic impedance
I_{RM}	Leakage current
I_{PP}	Peak pulse current

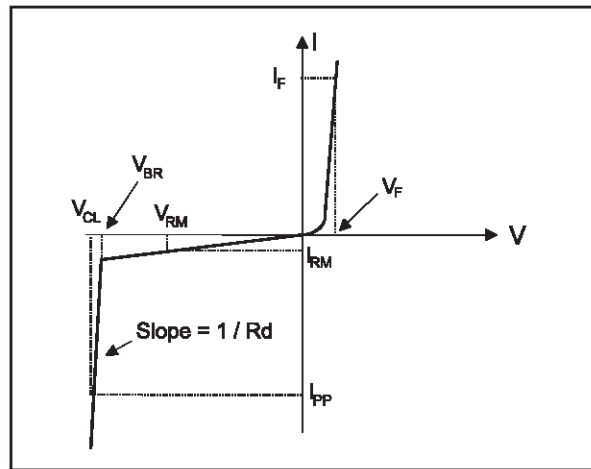

Symbol	Test conditions	Min.	Typ.	Max.	Unit
I_{RM}	$V_{RM} = 5.25\text{ V}$, between any I/O pin and GND			20	μA
V_{BR}	$I_R = 1\text{ mA}$, between any I/O pin and GND	6.1		7.2	V
V_F	$I_F = 200\text{ mA}$, between any I/O pin and GND			1.25	V
R_d	$I_{PP} = 15\text{ A}$, $t_p = 2.5\mu\text{s}$ (note 1)		0.2		Ω
C	Between any I/O pin and GND at 0 V bias Between any I/O pin and GND at $V_{RM} = 5.25\text{ V}$		260 130		pF

Note 1 : see the calculation of the clamping voltage.

CALCULATION OF THE CLAMPING VOLTAGE

USE OF THE DYNAMIC RESISTANCE

The ESDA family has been designed to clamp fast spikes like ESD. Generally the PCB designers need to calculate easily the clamping voltage V_{CL} . This is why we give the dynamic resistance in addition to the classical parameters. The voltage across the protection cell can be calculated with the following formula:

$$V_{CL} = V_{BR} + R_d I_{PP}$$

Where I_{PP} is the peak current through the ESDA cell.

As the value of the dynamic resistance remains stable for a surge duration lower than $20\mu s$, the $2.5\mu s$ rectangular surge is well adapted. In addition both rise and fall times are optimized to avoid any parasitic phenomenon during the measurement of R_d .

DYNAMIC RESISTANCE MEASUREMENT

The short duration of the ESD has led us to prefer a more adapted test wave, as below defined, to the classical $8/20\mu s$ and $10/1000\mu s$ surges.

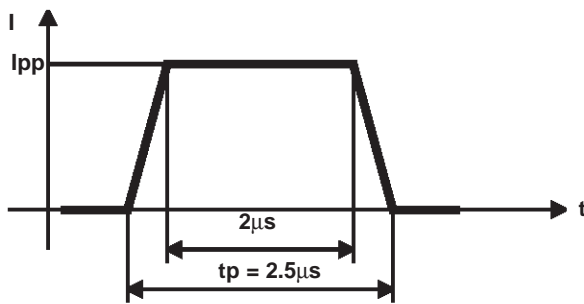

2.5 μs duration measurement wave.

Fig 1: Peak power dissipation versus initial junction temperature.

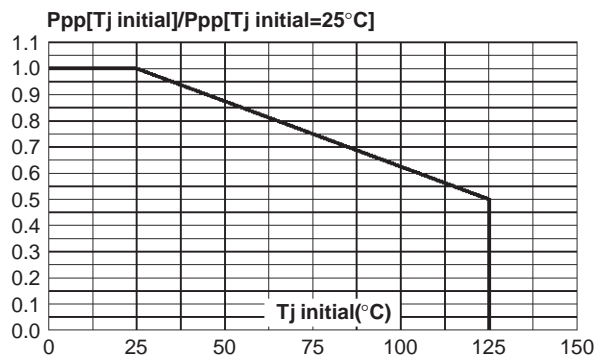

Fig 2: Peak pulse power versus exponential pulse duration ($T_j \text{ initial}=25^\circ\text{C}$).

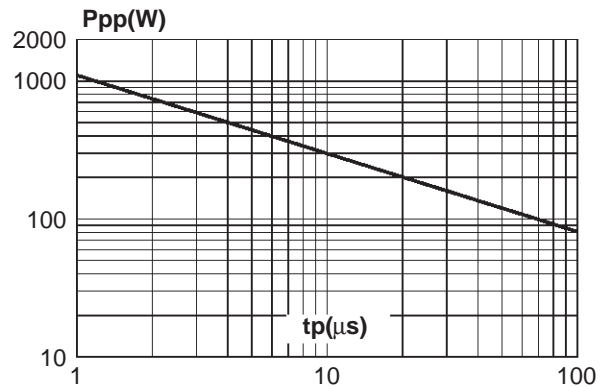

Fig 3: Clamping voltage versus peak pulse current ($T_j \text{ initial}=25^\circ\text{C}$, rectangular waveform $t_p=2.5\mu\text{s}$).

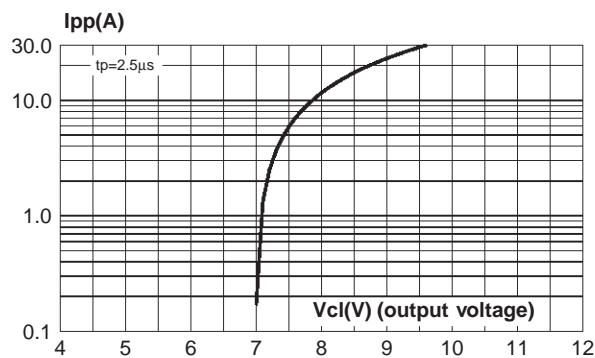

Fig 4: Capacitance versus reverse applied voltage (typical values).

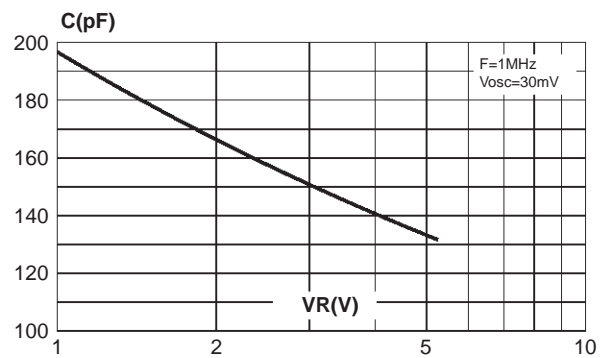

Fig 5: Relative variation of leakage current versus junction temperature (typical values).

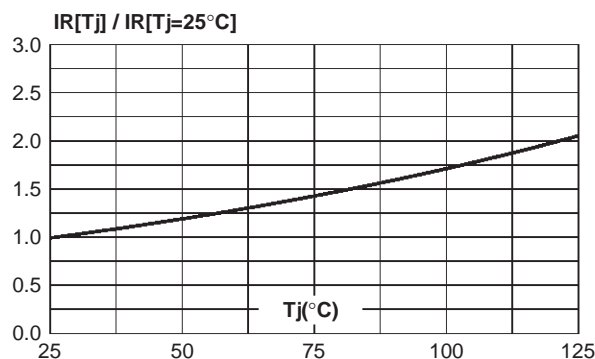
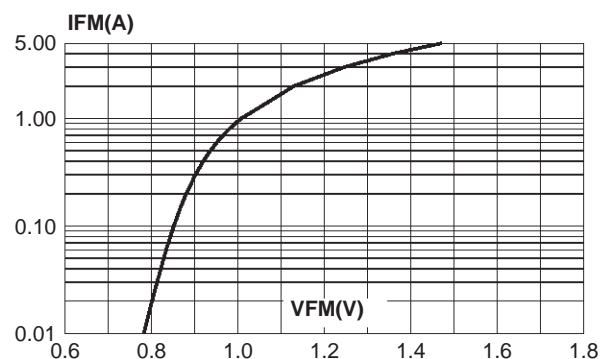

Fig 6: Peak forward voltage drop versus peak forward current (typical values). Rectangular waveform: $t_p = 2.5\mu\text{s}$



ESDA6V1FUx

ESD protection by the ESDA6V1FUx

Electrostatic discharge (ESD) is a major cause of failure in electronic systems.

Transient Voltage Suppressors (TVS) are an ideal choice for ESD protection. They are capable of clamping the incoming transient to a low enough level such that damage to the protected semiconductor is prevented.

Surface mount TVS arrays offer the best choice for minimal lead inductance.

They serve as parallel protection elements, connected between the signal line to ground. As the transient rises above the operating voltage of the device, the TVS array becomes a low impedance path diverting the transient current to ground.

Fig. 7 : Example of connection for one cell of the ESDA6V1FUx

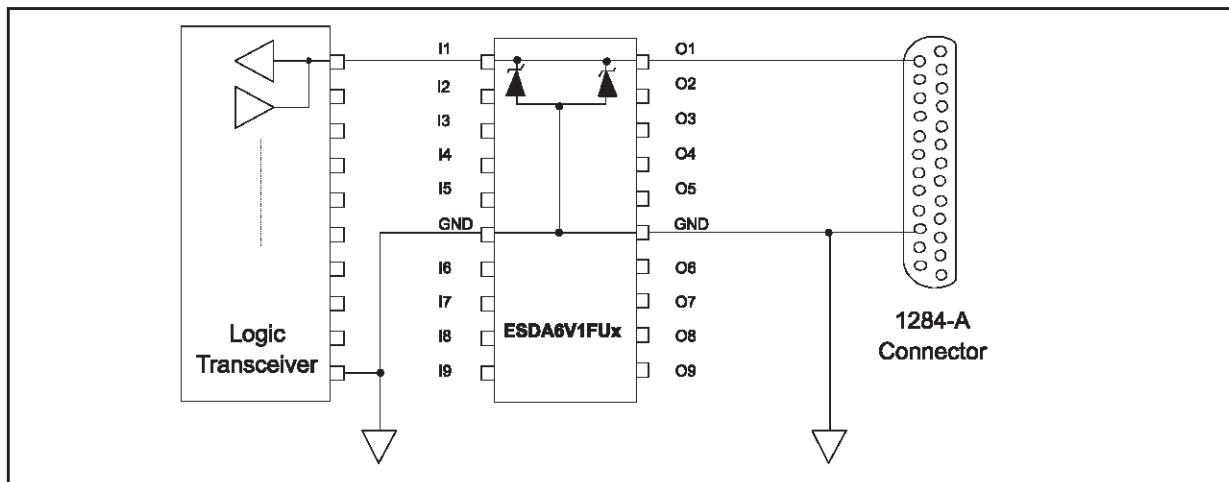

The ESDA6V1FUx array is the ideal board level protection of ESD sensitive semiconductor components. It provides best efficiency when using separated inputs and outputs, in the so called 4-points structure.

Circuit Board Layout

Circuit board layout is a critical design step in the suppression of ESD induced transients. The following guidelines are recommended :

- The ESDA6V1FUx should be placed as near as possible to the input terminals or connectors.
- The path length between the ESD suppressor and the protected line should be minimized.
- All conductive loops, including power and ground loops should be minimized.
- The ESD transient return path to ground should be kept as short as possible.
- Ground planes should be used whenever possible.

Fig. 8 : Recommended PCB layout to benefit from 4 point structure

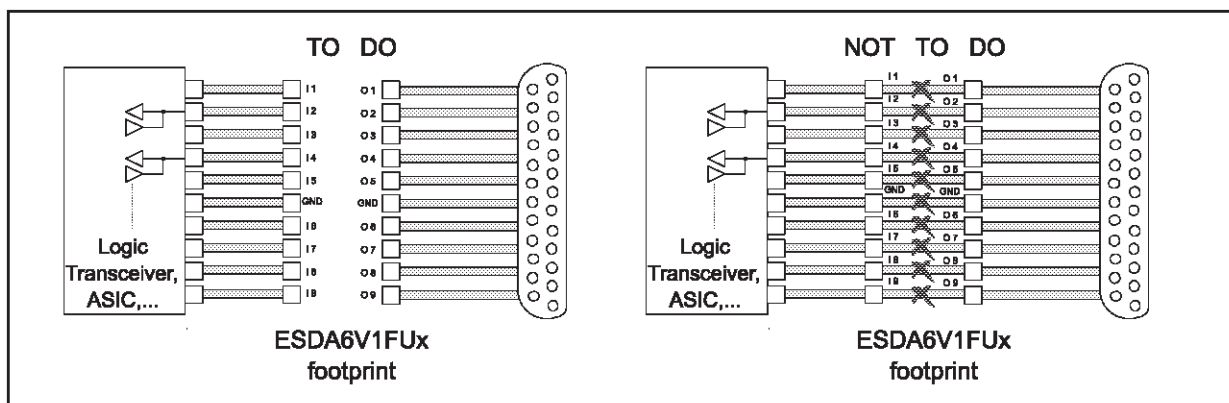

PART NUMBERING AND ORDERING INFORMATION

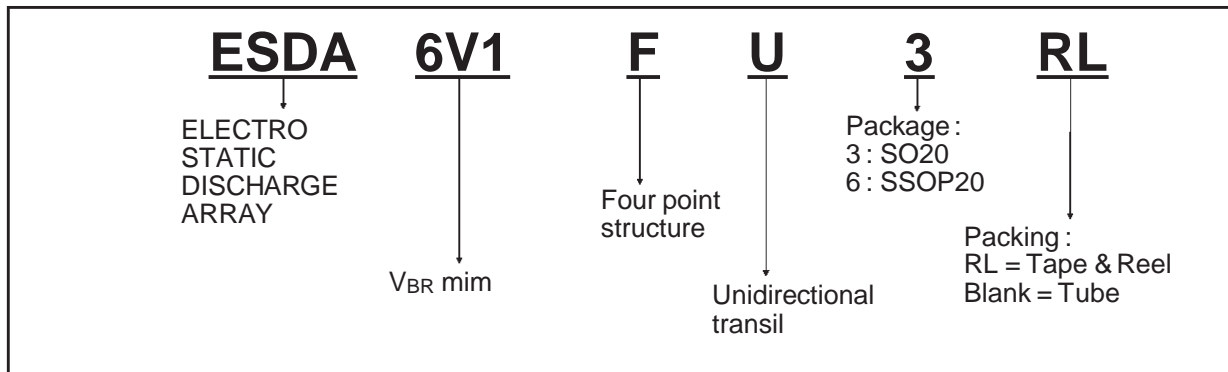

PACKAGE MECHANICAL DATA
SO20 (Plastic)

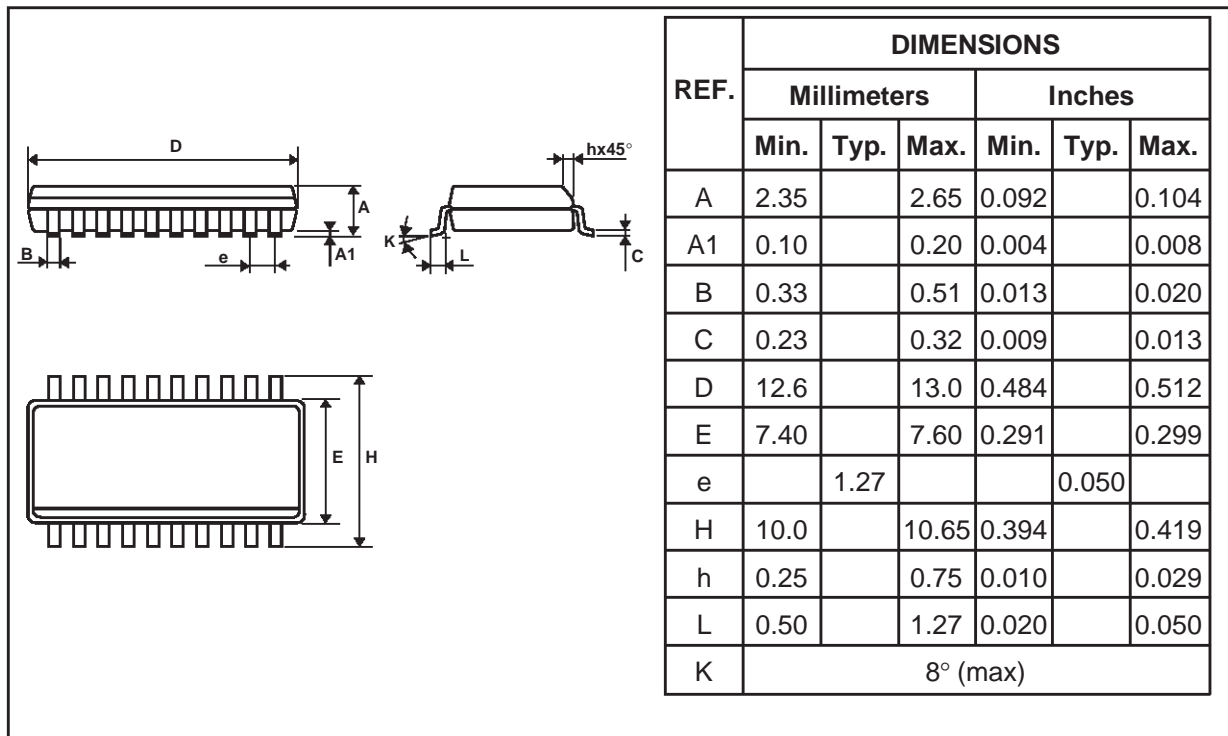

ESDA6V1FUx

PACKAGE MECHANICAL DATA

SSOP20 (Plastic)

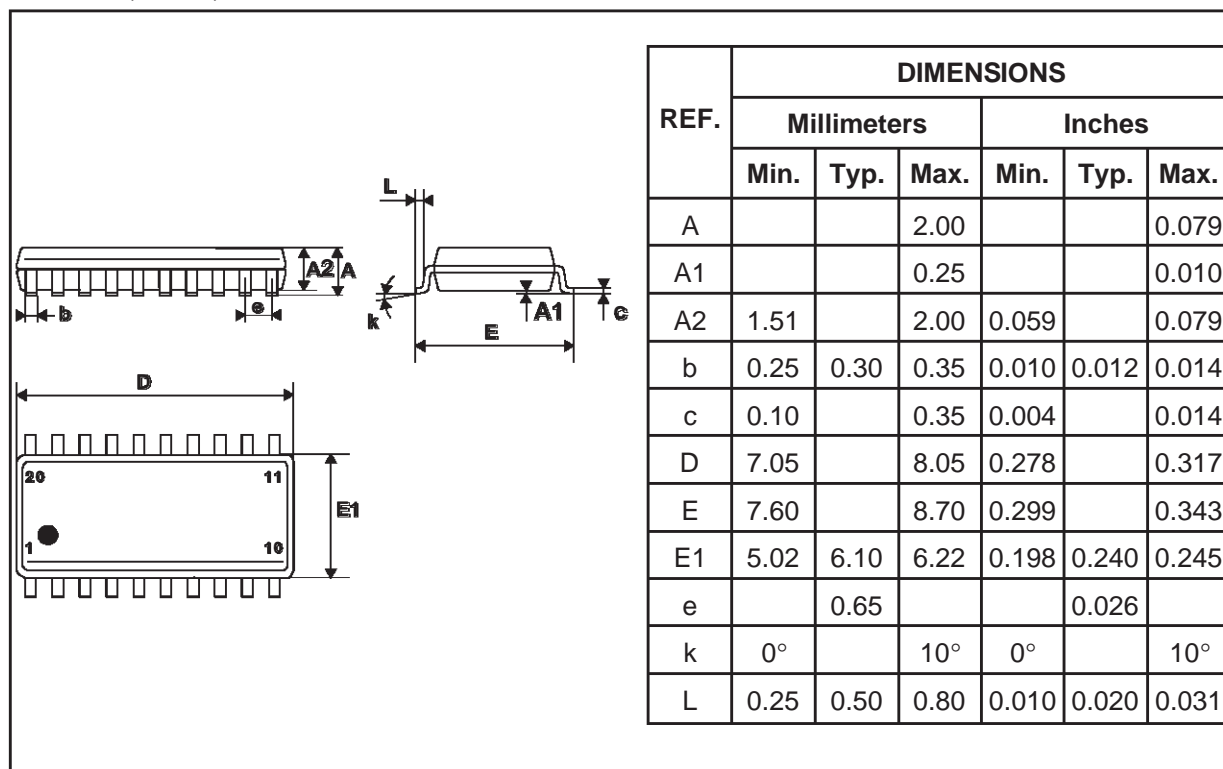

ORDERING CODE

Order code	Marking	Package	Weight	Delivery mode	Base qty (pcs)
ESDA6V1FU3	ESDA6V1FU3	SO20	0.52g	Tube	50
ESDA6V1FU3RL	ESDA6V1FU3	SO20	0.52g	Tape & reel	1000
ESDA6V1FU6	ESDA6V1FU6	SSOP20	0.18g	Tube	66
ESDA6V1FU6RL	ESDA6V1FU6	SSOP20	0.18g	Tape & reel	2000

Information furnished is believed to be accurate and reliable. However, STMicroelectronics assumes no responsibility for the consequences of use of such information nor for any infringement of patents or other rights of third parties which may result from its use. No license is granted by implication or otherwise under any patent or patent rights of STMicroelectronics. Specifications mentioned in this publication are subject to change without notice. This publication supersedes and replaces all information previously supplied. STMicroelectronics products are not authorized for use as critical components in life support devices or systems without express written approval of STMicroelectronics.

The ST logo is a registered trademark of STMicroelectronics

© 1998 STMicroelectronics - Printed in Italy - All rights reserved.

STMicroelectronics GROUP OF COMPANIES

Australia - Brazil - Canada - China - France - Germany - Italy - Japan - Korea - Malaysia - Malta - Mexico - Morocco - The Netherlands - Singapore - Spain - Sweden - Switzerland - Taiwan - Thailand - United Kingdom - U.S.A.

<http://www.st.com>