

Power Phototriac

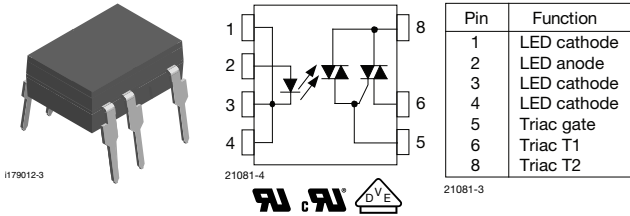

FEATURES

- Maximum trigger current (I_{FT}): 10 mA
- Isolation test voltage 5300 V_{RMS}
- Peak off-state voltage 600 V
- Load current 1 A_{RMS}
- dV/dt of 210 V/μs
- DIP-8 package
- Pure tin leads
- Compliant to RoHS Directive 2002/95/EC

RoHS
COMPLIANT

DESCRIPTION

The VO2223A is an optically couple phototriac driving a power triac in a DIP-8 package. It provides a 5300 V of input to output isolation.

APPLICATIONS

- Home appliances (air conditioners, microwave ovens, washing machines, personal hygiene systems, refrigerators, fan heaters, inductive heating cooker, water heaters, etc.)
- Industrial equipments

AGENCY APPROVALS

- UL - E52744 system code H
- cUL - E52744 system code H
- VDE - DIN EN60747-5-2 (VDE 0884)

ORDERING INFORMATION

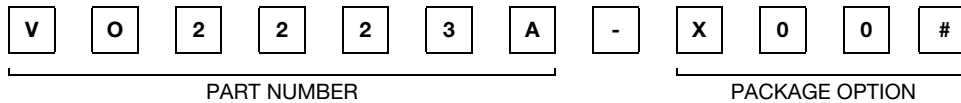

AGENCY CERTIFIED/PACKAGE	TRIGGER, CURRENT I_{FT} (mA)
UL, cUL	10
DIP-8	VO2223A
VDE	10
DIP-8	VO2223A-X001

ABSOLUTE MAXIMUM RATINGS ⁽¹⁾ ($T_{amb} = 25\text{ }^{\circ}\text{C}$, unless otherwise specified)

PARAMETER	TEST CONDITION	SYMBOL	VALUE	UNIT
INPUT				
LED continuous forward current		I_F	50	mA
LED reverse voltage		V_R	5	V
OUTPUT				
Repetitive peak off-state voltage	Sine wave, 50 Hz to 60 Hz, gate open	V_{DRM}	600	V
On-state RMS current		$I_{T(RMS)}$	1	A
Peak non-repetitive surge current (50 Hz, peak)		I_{TSM}	10	A
COUPLER				
Total power dissipation ⁽³⁾		P_{diss}	1.2	W
Ambient temperature range		T_{amb}	- 40 to + 85	$^{\circ}\text{C}$
Storage temperature range		T_{stg}	- 40 to + 125	$^{\circ}\text{C}$
Soldering temperature ⁽²⁾	$t \leq 10\text{ s max.}$	T_{slid}	260	$^{\circ}\text{C}$
Isolation test voltage	for 1 s	V_{ISO}	5300	V_{RMS}

Notes

- (1) Stresses in excess of the absolute maximum ratings can cause permanent damage to the device. Functional operation of the device is not implied at these or any other conditions in excess of those given in the operational sections of this document. Exposure to absolute maximum ratings for extended periods of the time can adversely affect reliability.
- (2) Refer to wave profile for soldering conditions for through hole devices.
- (3) Total power dissipation value is based on 2S2P PCB.

ABSOLUTE MAXIMUM RATING CURVES

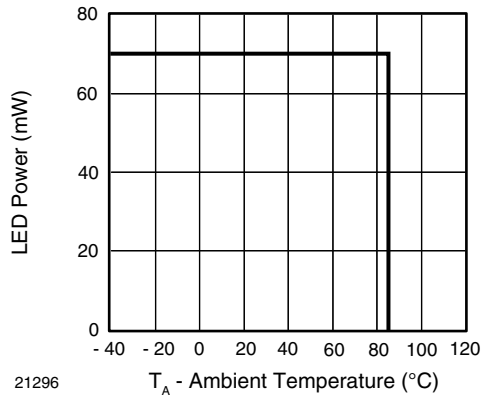

Fig. 1 - Power Dissipation vs. Temperature

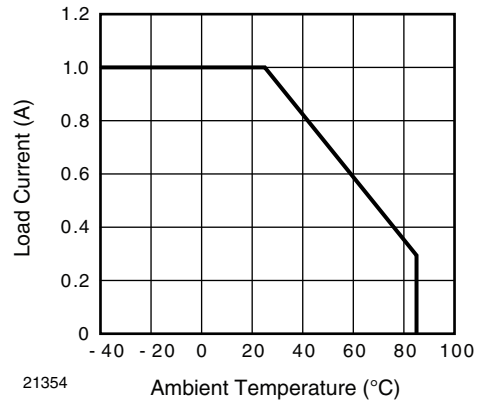

Fig. 2 - Allowable Load Current vs. Ambient Temperature

Note

- The allowable load current was calculated out under a given operating conditions and only for reference:
LED power: $Q_E = 0.015 \text{ W}$, $\theta_{BA} \text{ (4-layer)} = 30 \text{ }^\circ\text{C/W}$

ELECTRICAL CHARACTERISTICS ($T_{amb} = 25 \text{ }^\circ\text{C}$, unless otherwise specified)						
PARAMETER	TEST CONDITION	SYMBOL	MIN.	TYP.	MAX.	UNIT
INPUT						
LED trigger current	$V_T = 6 \text{ V}$	I_{FT}			10	mA
Input reverse current	$V_R = 5 \text{ V}$	I_R			10	μA
LED forward voltage	$I_F = 10 \text{ mA}$	V_F	0.9		1.4	V
OUTPUT						
Peak on-state voltage	$I_{TM} = 1 \text{ A}$	V_{TM}			1.7	V
Peak off-state current	$V_{DRM} = 600 \text{ V}$, $T_A = 110 \text{ }^\circ\text{C}$	I_{DRM}			100	μA
Holding current	$R_L = 100 \text{ } \Omega$	I_H			25	mA
Critical rate of rise of off-state voltage	$V_{IN} = 400 \text{ V}_{RMS}$ (fig. 3)	dV/dt		210		$\text{V}/\mu\text{s}$
Critical rate of rise of commutating voltage	$V_{IN} = 240 \text{ V}_{RMS}$, $I_T = 1 \text{ A}_{RMS}$ (fig. 3)	$dV/dt \text{ (c)}$		0.7		$\text{V}/\mu\text{s}$

Note

- Minimum and maximum values are testing requirements. Typical values are characteristics of the device and are the result of engineering evaluations. Typical values are for information only and are not part of the testing requirements.

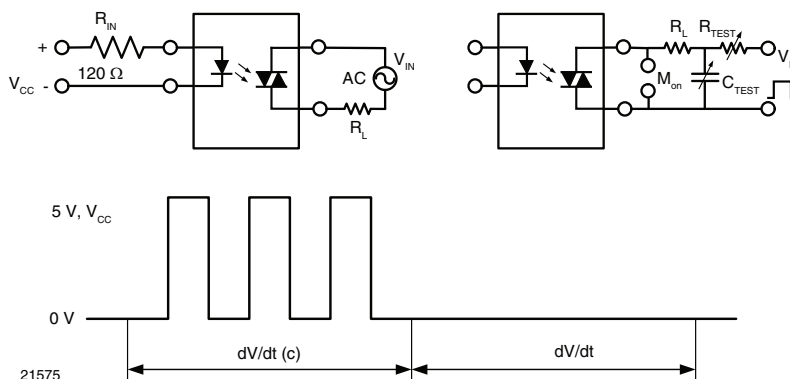

Fig. 3 - dV/dt Test Circuit

SAFETY AND INSULATION RATINGS						
PARAMETER	TEST CONDITION	SYMBOL	MIN.	TYP.	MAX.	UNIT
Climatic classification	IEC 68 part 1			40/85/21		
Pollution degree	DIN VDE 0109			2		
Tracking resistance (comparative tracking index)	Insulation group IIIa	CTI	175			
Highest allowable overvoltage	Transient overvoltage	V_{IOTM}	8000			V_{peak}
Maximum working insulation voltage	Recurring peak voltage	V_{IORM}	890			V_{peak}
Insulation resistance at 25 °C	$V_{IO} = 500 V$	R_{IS}			$\geq 10^{12}$	Ω
Insulation resistance at T_S	$V_{IO} = 500 V$	R_{IS}			$\geq 10^9$	Ω
Insulation resistance at 100 °C	$V_{IO} = 500 V$	R_{IS}			$\geq 10^{11}$	Ω
Partial discharge test voltage	Method b, $V_{pd} = V_{IORM} \times 1.6$	V_{pd}			1424	V_{peak}
Safety limiting values - maximum values allowed in the event of a failure	Case temperature	T_{SI}			165	°C
	Input current	I_{SI}			150	mA
	Output power	P_{SO}			2000	mW
Minimum external air gap (clearance distance)	Measured from input terminals to output terminals, shortest distance through air		≥ 7			mm
Minimum external tracking (creepage distance)	Measured from input terminals to output terminals, shortest distance path along body		≥ 7			mm

Note

- This phototriac coupler is suitable for "safe electrical insulation" only within the safety ratings. Compliance with safety ratings shall be ensured by means of protective circuits.

TYPICAL CHARACTERISTICS ($T_{amb} = 25\text{ °C}$, unless otherwise specified)

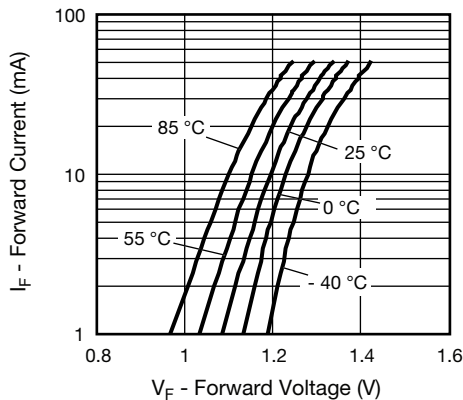

Fig. 4 - Forward Current vs. Forward Voltage

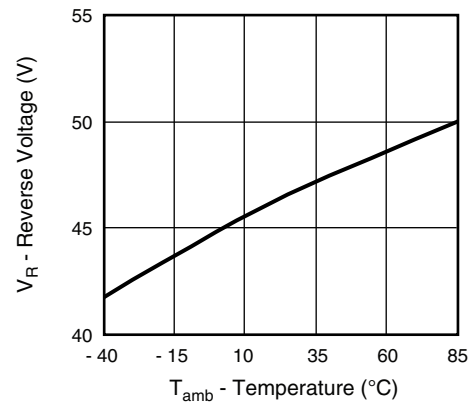

Fig. 5 - Reverse Voltage vs. Temperature

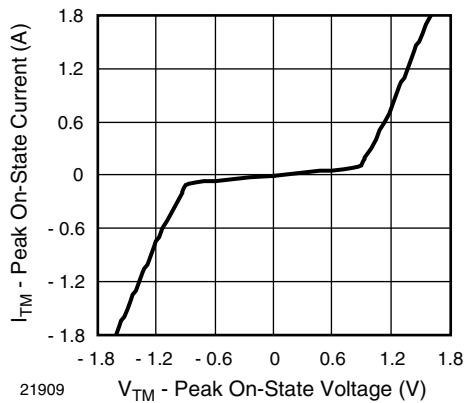

Fig. 6 - On-State Current vs. On-State Voltage

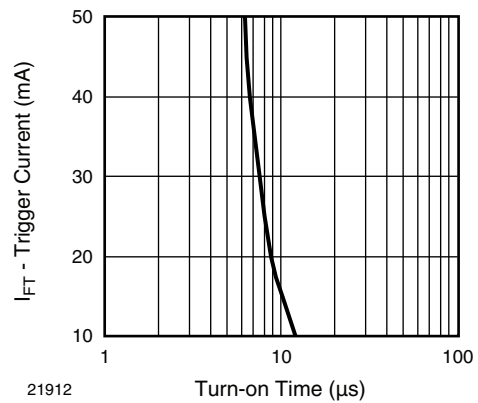

Fig. 9 - Trigger Input Current vs. Turn-on Time

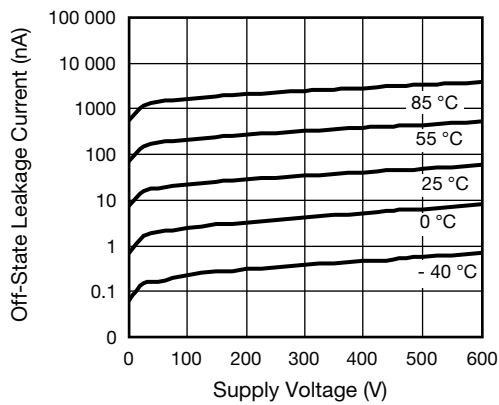

Fig. 7 - Off-State Leakage Current vs. Voltage

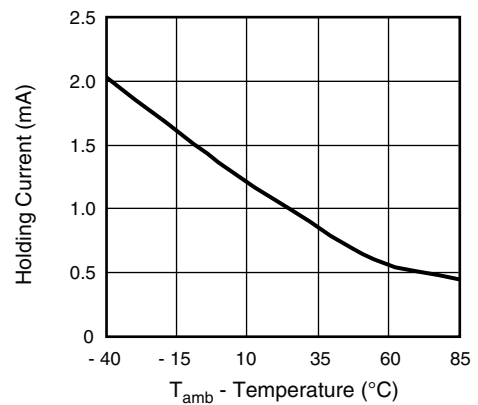

Fig. 10 - Normalized Holding Current vs. Temperature

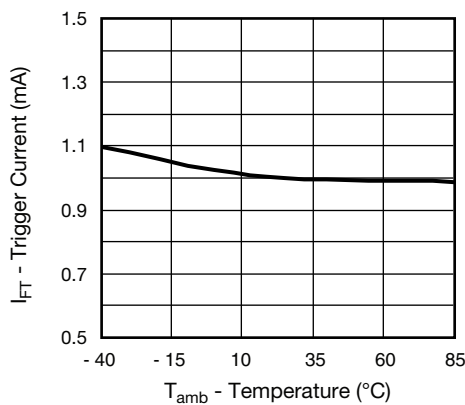

Fig. 8 - Normalized Trigger Input Current vs. Temperature

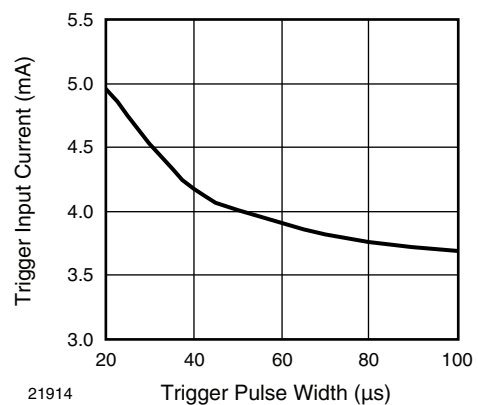

Fig. 11 - Trigger Current vs. Trigger Pulse Width

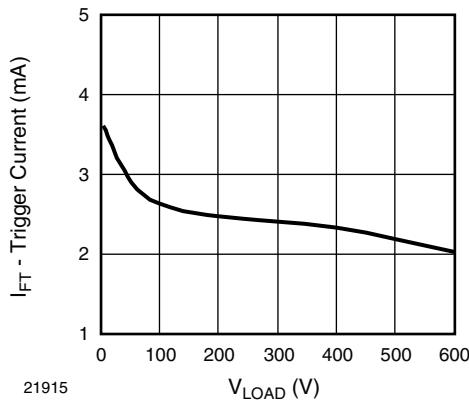
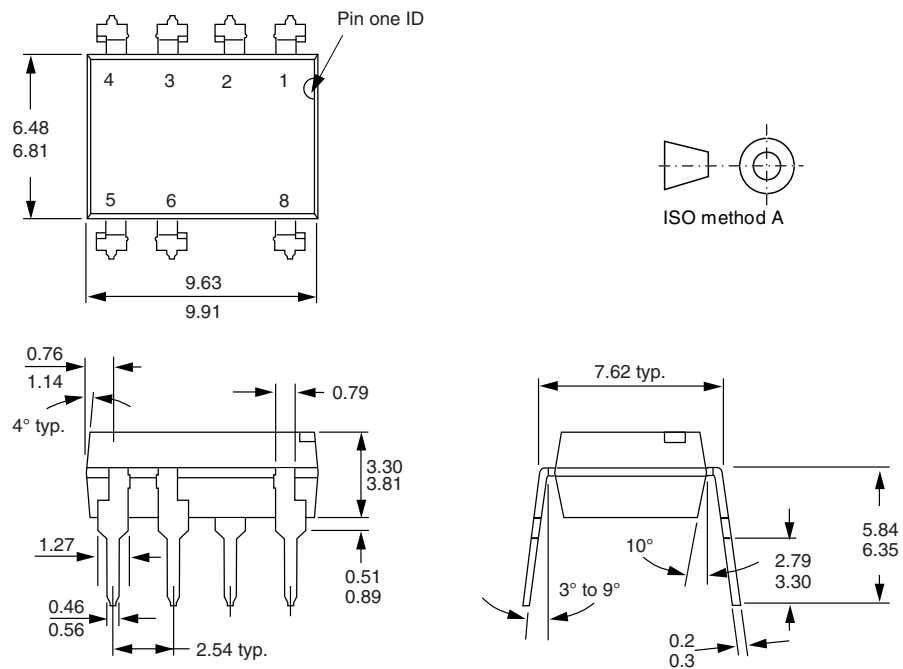

Fig. 12 - Trigger Current vs. V_LOAD

PACKAGE DIMENSIONS in millimeters



i178006-1

PACKAGE MARKING



21764-49



Disclaimer

ALL PRODUCT, PRODUCT SPECIFICATIONS AND DATA ARE SUBJECT TO CHANGE WITHOUT NOTICE TO IMPROVE RELIABILITY, FUNCTION OR DESIGN OR OTHERWISE.

Vishay Intertechnology, Inc., its affiliates, agents, and employees, and all persons acting on its or their behalf (collectively, "Vishay"), disclaim any and all liability for any errors, inaccuracies or incompleteness contained in any datasheet or in any other disclosure relating to any product.

Vishay makes no warranty, representation or guarantee regarding the suitability of the products for any particular purpose or the continuing production of any product. To the maximum extent permitted by applicable law, Vishay disclaims (i) any and all liability arising out of the application or use of any product, (ii) any and all liability, including without limitation special, consequential or incidental damages, and (iii) any and all implied warranties, including warranties of fitness for particular purpose, non-infringement and merchantability.

Statements regarding the suitability of products for certain types of applications are based on Vishay's knowledge of typical requirements that are often placed on Vishay products in generic applications. Such statements are not binding statements about the suitability of products for a particular application. It is the customer's responsibility to validate that a particular product with the properties described in the product specification is suitable for use in a particular application. Parameters provided in datasheets and/or specifications may vary in different applications and performance may vary over time. All operating parameters, including typical parameters, must be validated for each customer application by the customer's technical experts. Product specifications do not expand or otherwise modify Vishay's terms and conditions of purchase, including but not limited to the warranty expressed therein.

Except as expressly indicated in writing, Vishay products are not designed for use in medical, life-saving, or life-sustaining applications or for any other application in which the failure of the Vishay product could result in personal injury or death. Customers using or selling Vishay products not expressly indicated for use in such applications do so at their own risk and agree to fully indemnify and hold Vishay and its distributors harmless from and against any and all claims, liabilities, expenses and damages arising or resulting in connection with such use or sale, including attorneys fees, even if such claim alleges that Vishay or its distributor was negligent regarding the design or manufacture of the part. Please contact authorized Vishay personnel to obtain written terms and conditions regarding products designed for such applications.

No license, express or implied, by estoppel or otherwise, to any intellectual property rights is granted by this document or by any conduct of Vishay. Product names and markings noted herein may be trademarks of their respective owners.

Material Category Policy

Vishay Intertechnology, Inc. hereby certifies that all its products that are identified as RoHS-Compliant fulfill the definitions and restrictions defined under Directive 2011/65/EU of The European Parliament and of the Council of June 8, 2011 on the restriction of the use of certain hazardous substances in electrical and electronic equipment (EEE) - recast, unless otherwise specified as non-compliant.

Please note that some Vishay documentation may still make reference to RoHS Directive 2002/95/EC. We confirm that all the products identified as being compliant to Directive 2002/95/EC conform to Directive 2011/65/EU.