

## Ultrafast Dual Common-Cathode Rectifier

### General Description

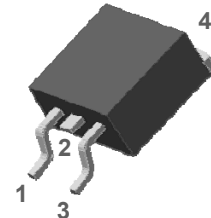
The SF20D400D2 is an ultrafast rectifier. It has a low forward voltage drop and reverse recovery time ( $t_{rr} < 30\text{ns}$ ). The device is intended for use as a free-wheeling, clamping rectifier in a variety of switching power supplies and other power switching applications.

### Features and Benefits

- Low forward drop voltage and low leakage current
- Ultrafast reverse recovery time ( $t_{rr} < 30\text{ns}$ )
- Dual common-cathode rectifier construction
- Full lead (Pb)-free device and RoHS compliant device

### Applications

- Switching power supply
- Power inverters
- Power conversion system
- DC/DC Converter system


**D2-PAK**

Product Characteristics	
$I_{F(AV)}$	2 x 10A
$V_{RRM}$	400V
$V_{FM}$ at 125°C	1.25V
$t_{rr}$	30ns

### Ordering Information

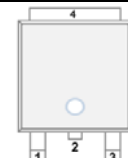
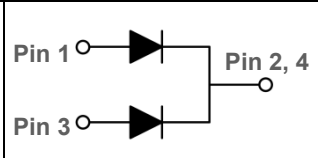
Part Number	Marking Code	Package	Packaging
SF20D400D2	SF20D400D2	D2-PAK	Tape & Reel

### Marking Information



**AUK** = Manufacture Logo  
**Δ** = Control Code of Manufacture  
**YMDD** = Date Code Marking  
 -. **Y** = Year Code  
 -. **M** = Monthly Code  
 -. **DD** = Daily Code  
**SF20D400D2** = Specific Device Code

### Pinning Information

Pin	Description	Simplified Outline	Graphic Symbol
1	Anode		
2, 4	Common-Cathode		
3	Anode		

## Absolute Maximum Ratings (Limiting values at 25°C, unless otherwise specified)

Characteristic		Symbol	Ratings	Unit
Maximum repetitive reverse voltage Maximum working peak reverse voltage Maximum DC blocking voltage		$V_{RRM}$ $V_{RWM}$ $V_R$	400	V
Maximum average forward rectified current	per diode	$I_{F(AV)}$	10	A
	total device		20	
Peak forward surge current 8.3ms single half sine-wave superimposed on rated load per diode		$I_{FSM}$	120	A
Storage temperature range		$T_{stg}$	-45 to +150	°C
Maximum operating junction temperature		$T_J$	150	

## Thermal Characteristics

Characteristic		Symbol	Ratings	Unit
Thermal resistance, junction to case	per diode	$R_{th(j-c)}$	3.0	°C/W
	total device		2.6	

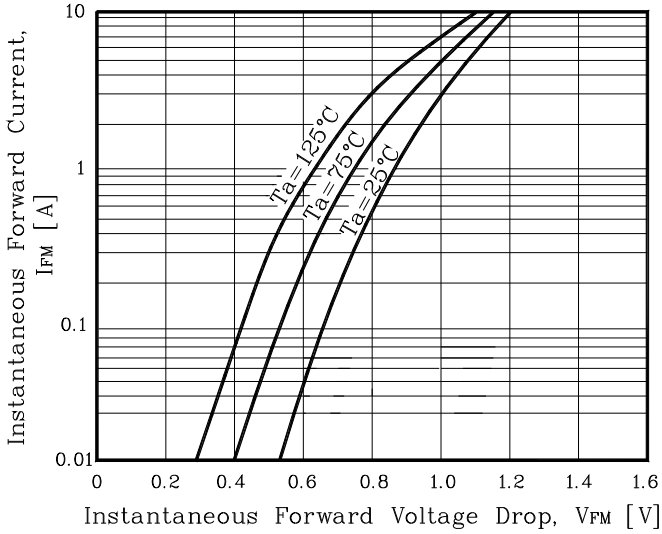
## Electrical Characteristics

Characteristic	Symbol	Test Condition	Min.	Typ.	Max.	Unit	
Peak forward voltage drop	$V_{FM}^{(1)}$	$I_{FM} = 10A$	$T_j=25^\circ C$	-	-	1.40	V
			$T_j=125^\circ C$	-	-	1.25	
Reverse leakage current	$I_{RM}^{(1)}$	$V_R = V_{RRM}$	$T_j=25^\circ C$	-	-	20	uA
			$T_j=125^\circ C$	-	-	200	
Reverse recovery time	$t_{rr}$	$I_F = 1A, di/dt = -100 A/us$	-	-	30	ns	
Junction capacitance	$C_j$	$V_R = 10V_{DC}, f=1MHz$	-	65	-	pF	

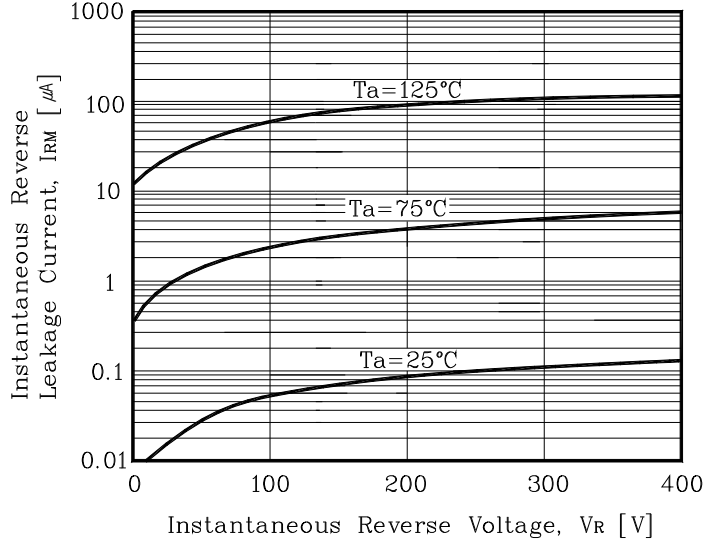
<sup>1)</sup> Pulse test:  $t_p \leq 380us$ , Duty cycle  $\leq 2\%$

## Rating & Electrical Characteristic Curves

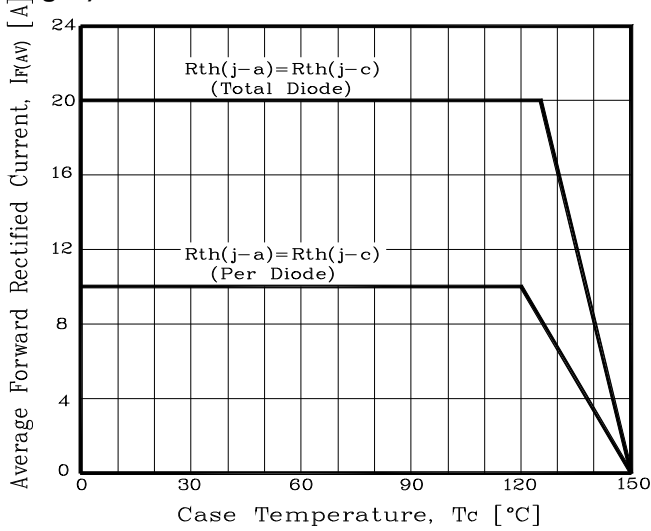
**Fig. 1) Typical Forward Characteristics (Per diode)**



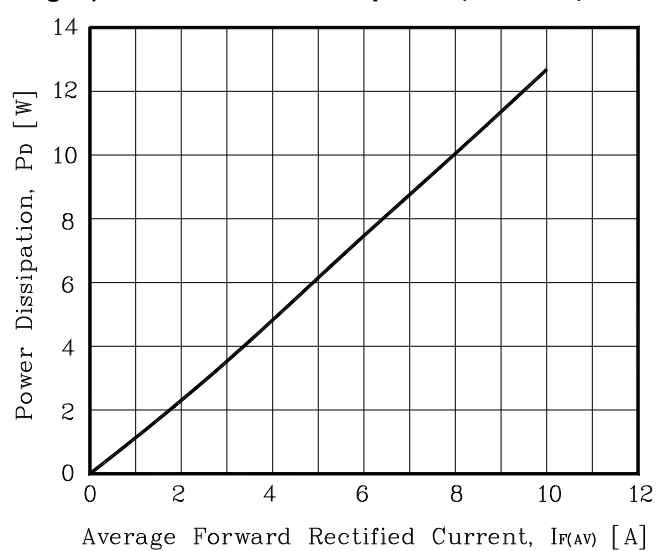
**Fig. 2) Typical Reverse Characteristics (Per diode)**



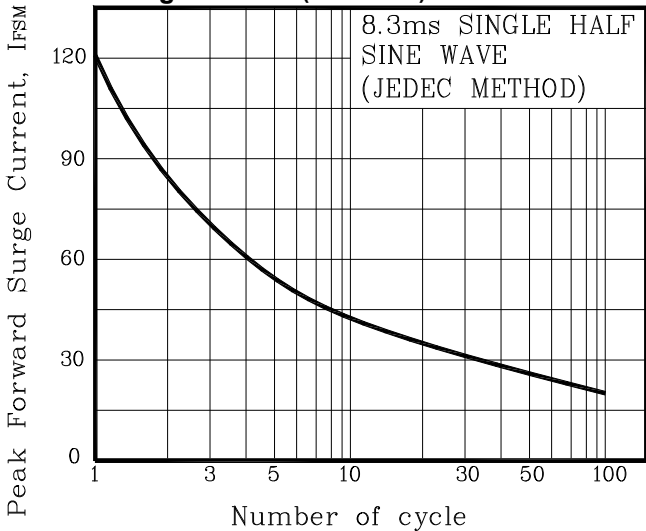
**Fig. 3) Maximum Forward Derivative Curve**



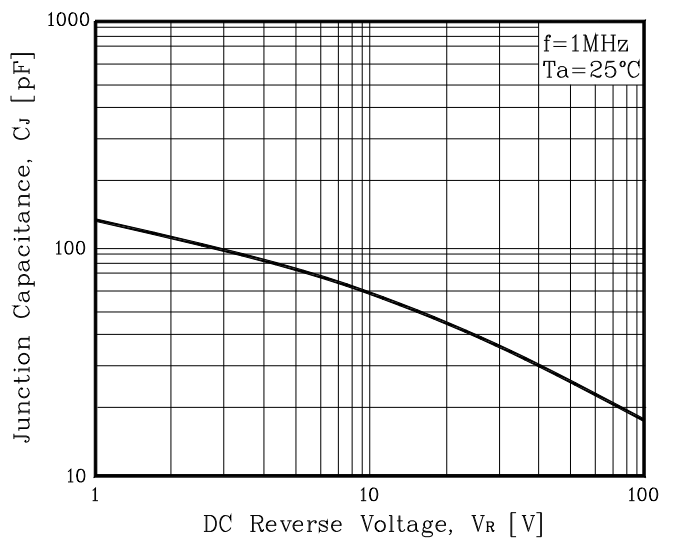
**Fig. 4) Forward Power Dissipation (Per diode)**



**Fig. 5) Maximum Non-Repetitive Peak Forward Surge Current (Per diode)**

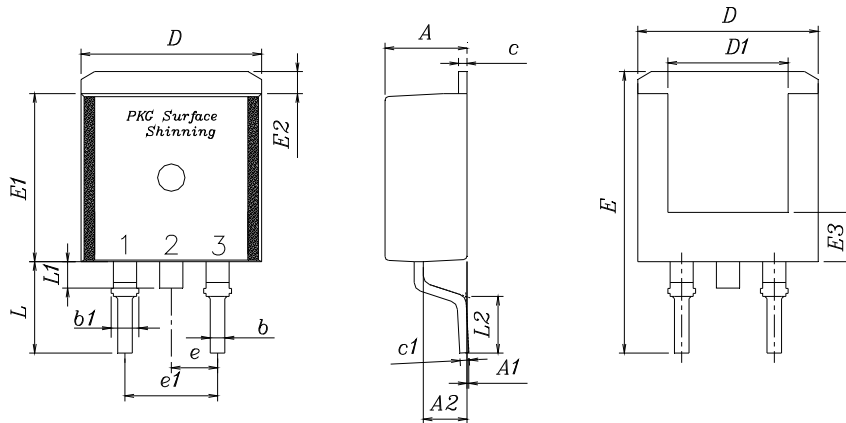


**Fig. 6) Typical Junction Capacitance (Per diode)**



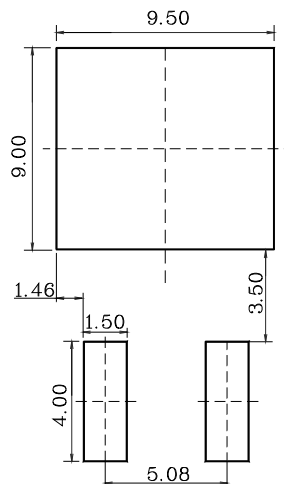
## Package Outline Dimensions

Unit: mm



SYMBOL	MILLIMETERS			NOTE
	MINIMUM	NOMINAL	MAXIMUM	
A	4.35	4.50	4.65	
A1	—	—	0.15	
A2	2.20	2.40	2.60	
b	0.70	0.80	0.90	
b1	1.17	1.27	1.37	
c	0.40	0.50	0.60	
c1	0.40	0.50	0.60	
D	9.80	10.00	10.20	
D1	6.40	6.60	6.80	
E	15.00	15.40	15.80	
E1	9.05	9.20	9.35	
E2	1.00	1.20	1.40	
E3	2.50	2.70	2.90	
e	2.34	2.54	2.74	
e1	4.88	5.08	5.28	
L	4.60	5.00	5.40	
L1	1.40	1.45	1.50	
L2	2.50	—	—	

※ Recommend PCB solder land (Unit : mm)



**The AUK Corp. products are intended for the use as components in general electronic equipment (Office and communication equipment, measuring equipment, home appliance, etc.).**

**Please make sure that you consult with us before you use these AUK Corp. products in equipments which require high quality and / or reliability, and in equipments which could have major impact to the welfare of human life(atomic energy control, airplane, spaceship, transportation, combustion control, all types of safety device, etc.). AUK Corp. cannot accept liability to any damage which may occur in case these AUK Corp. products were used in the mentioned equipments without prior consultation with AUK Corp..**

**Specifications mentioned in this publication are subject to change without notice.**