

Dual P-Channel Enhancement Mode MOSFET

Features

- 20V/-3.4A ,
 - $R_{DS(ON)} = 45m\Omega (typ.) @ V_{GS} = -4.5V$
 - $R_{DS(ON)} = 52m\Omega (typ.) @ V_{GS} = -3V$
 - $R_{DS(ON)} = 60m\Omega (typ.) @ V_{GS} = -2.7V$
- Super High Dense Cell Design
- Reliable and Rugged
- Lead Free and Green Devices Available (RoHS Compliant)

Pin Description

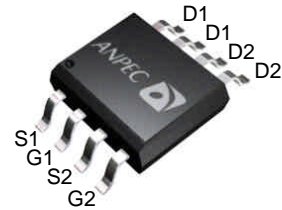

Top View of SOP – 8

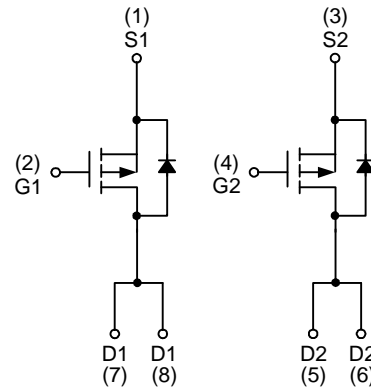

P-Channel MOSFET

Applications

- Power Management in Notebook Computer, Portable Equipment and Battery Powered Systems

Ordering and Marking Information

<p>APM9933 □□-□□ □</p> <p style="margin-left: 20px;"> └─ Assembly Material └─ Handling Code └─ Temperature Range └─ Package Code </p>	<p>Package Code K : SOP-8</p> <p>Operating Junction Temperature Range C : -55 to 150 °C</p> <p>Handling Code TR : Tape & Reel</p> <p>Assembly Material L : Lead Free Device G : Halogen and Lead Free Device</p>
<p>APM9933 K : APM9933 XXXXX</p>	<p>XXXXXX - Date Code</p>

Note: ANPEC lead-free products contain molding compounds/die attach materials and 100% matte tin plate termination finish; which are fully compliant with RoHS. ANPEC lead-free products meet or exceed the lead-free requirements of IPC/JEDEC J-STD-020C for MSL classification at lead-free peak reflow temperature. ANPEC defines “Green” to mean lead-free (RoHS compliant) and halogen free (Br or Cl does not exceed 900ppm by weight in homogeneous material and total of Br and Cl does not exceed 1500ppm by weight).

ANPEC reserves the right to make changes to improve reliability or manufacturability without notice, and advise customers to obtain the latest version of relevant information to verify before placing orders.

Absolute Maximum Ratings ($T_A = 25^\circ\text{C}$ unless otherwise noted)

Symbol	Parameter	Rating	Unit	
V_{DSS}	Drain-Source Voltage	-20	V	
V_{GSS}	Gate-Source Voltage	± 12		
I_D^*	Continuous Drain Current	$V_{GS} = -4.5\text{V}$ -3.4	A	
I_{DM}^*	300 μs Pulsed Drain Current			-15
I_S^*	Diode Continuous Forward Current	-2	A	
T_J	Maximum Junction Temperature	150	$^\circ\text{C}$	
T_{STG}	Storage Temperature Range	-55 to 150		
P_D^*	Maximum Power Dissipation	$T_A = 25^\circ\text{C}$	2	W
		$T_A = 100^\circ\text{C}$	0.8	
$R_{\theta JA}^*$	Thermal Resistance-Junction to Ambient	62.5	$^\circ\text{C}/\text{W}$	

Note : *Surface Mounted on 1in² pad area, t ≤ 10sec.

Electrical Characteristics ($T_A = 25^\circ\text{C}$ unless otherwise noted)

Symbol	Parameter	Test Conditions	APM9933K			Unit
			Min.	Typ.	Max.	
STATIC CHARACTERISTICS						
BV_{DSS}	Drain-Source Breakdown Voltage	$V_{GS} = 0\text{V}, I_{DS} = -250\mu\text{A}$	-20	-	-	V
$\frac{\Delta BV_{DSS}}{\Delta T_J}$	Breakdown Voltage Temperature Coefficient	$I_D = -250\mu\text{A}$, Referenced to 25°C	-	-16	-	mV/ $^\circ\text{C}$
I_{DSS}	Zero Gate Voltage Drain Current	$V_{DS} = -16\text{V}, V_{GS} = 0\text{V}$ $T_J = 85^\circ\text{C}$	-	-	-1	μA
			-	-	-30	
$V_{GS(th)}$	Gate Threshold Voltage	$V_{DS} = V_{GS}, I_{DS} = -250\mu\text{A}$	-0.5	-0.7	-1	V
I_{GSS}	Gate Leakage Current	$V_{GS} = \pm 12\text{V}, V_{DS} = 0\text{V}$	-	-	± 100	nA
$\frac{\Delta V_{GS(th)}}{\Delta T_J}$	Gate Threshold Voltage Temperature Coefficient	$I_D = -250\mu\text{A}$, Referenced to 25°C	-	2.5	-	mV/ $^\circ\text{C}$
$R_{DS(ON)}^a$	Drain-Source On-State Resistance	$V_{GS} = -4.5\text{V}, I_{DS} = -3.4\text{A}$	-	45	70	m Ω
		$V_{GS} = -3\text{V}, I_{DS} = -2.9\text{A}$	-	52	80	
		$V_{GS} = -2.7\text{V}, I_{DS} = -2.6\text{A}$	-	60	100	
V_{SD}^a	Diode Forward Voltage	$I_{SD} = -2\text{A}, V_{GS} = 0\text{V}$	-	-0.7	-1.3	V

Electrical Characteristics (Cont.) (T_A = 25°C unless otherwise noted)

Symbol	Parameter	Test Conditions	APM9933K			Unit
			Min.	Typ.	Max.	
GATE CHARGE CHARACTERISTICS^b						
Q _g	Total Gate Charge	V _{DS} =-10V, V _{GS} =-4.5V, I _{DS} =-3.4A	-	12.7	15	nC
Q _{gs}	Gate-Source Charge		-	1.8	-	
Q _{gd}	Gate-Drain Charge		-	2.8	-	
DYNAMIC CHARACTERISTICS^b						
R _G	Gate Resistance	V _{GS} =0V, V _{DS} =0V, F=1MHz	-	9.8	-	Ω
C _{iss}	Input Capacitance	V _{GS} =0V, V _{DS} =-15V, Frequency=1.0MHz	-	1290	-	pF
C _{oss}	Output Capacitance		-	300	-	
C _{rss}	Reverse Transfer Capacitance		-	210	-	
t _{d(ON)}	Turn-on Delay Time	V _{DD} =-10V, R _L =10Ω, I _{DS} =-1A, V _{GEN} =-4.5V, R _G =6Ω	-	12	22	ns
T _r	Turn-on Rise Time		-	25	46	
t _{d(OFF)}	Turn-off Delay Time		-	52	95	
T _f	Turn-off Fall Time		-	18	33	

Note a : Pulse test ; pulse width ≤ 300μs, duty cycle ≤ 2%.

Note b : Guaranteed by design, not subject to production testing.

Typical Operating Characteristics

Power Dissipation

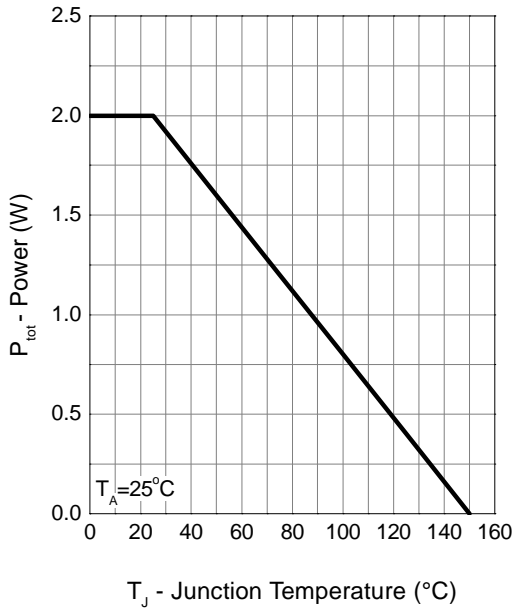

Drain Current

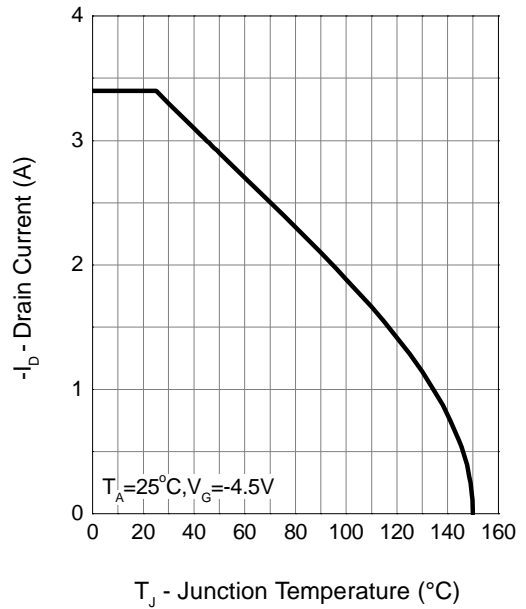

Safe Operation Area

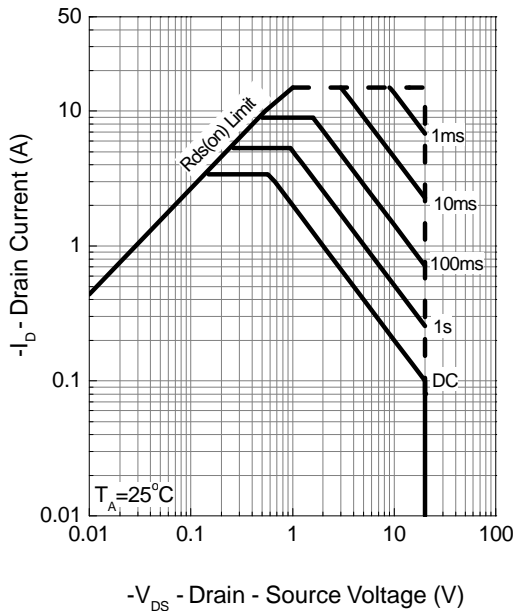

Thermal Transient Impedance

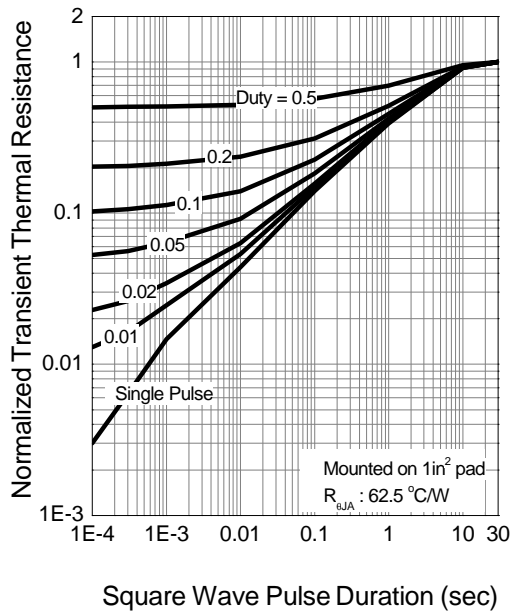

Typical Operating Characteristics (Cont.)

Output Characteristics

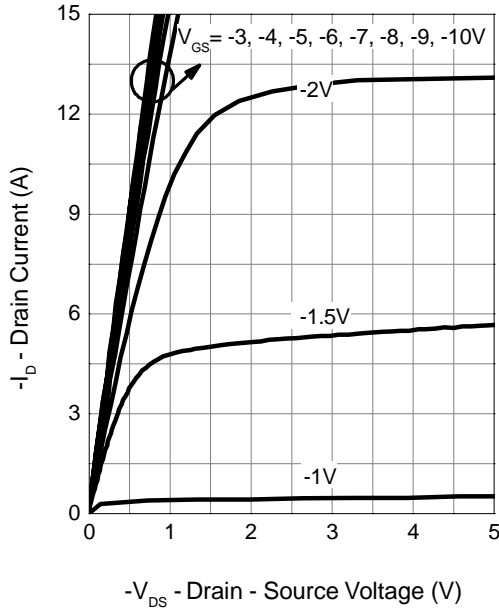

Drain-Source On Resistance

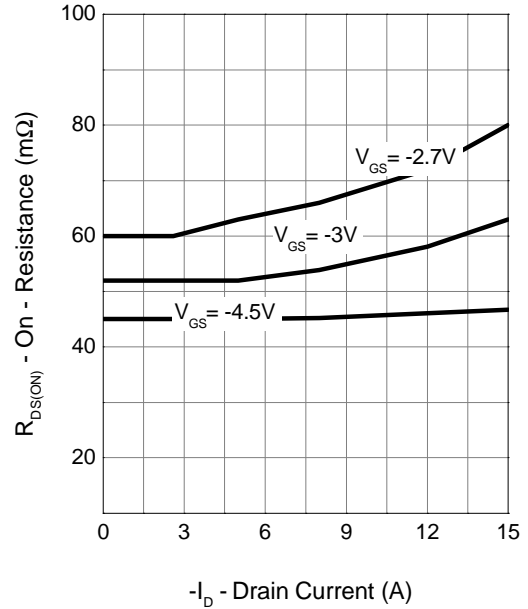

Transfer Characteristics

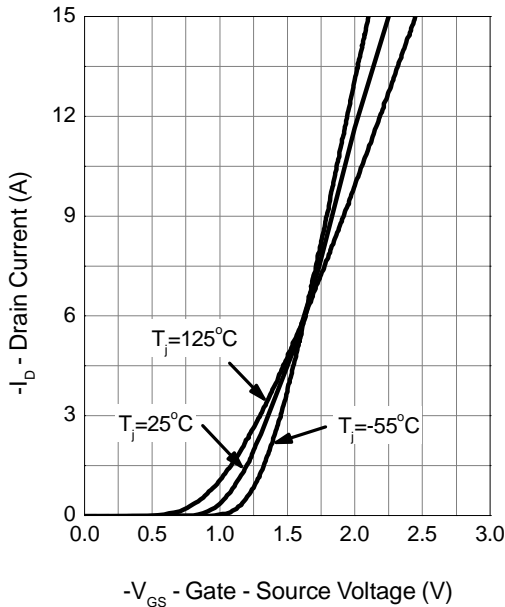

Gate Threshold Voltage

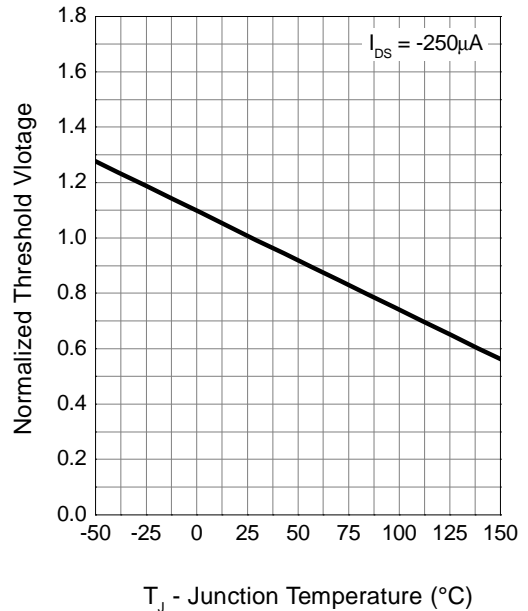

Typical Operating Characteristics (Cont.)

Drain-Source On Resistance

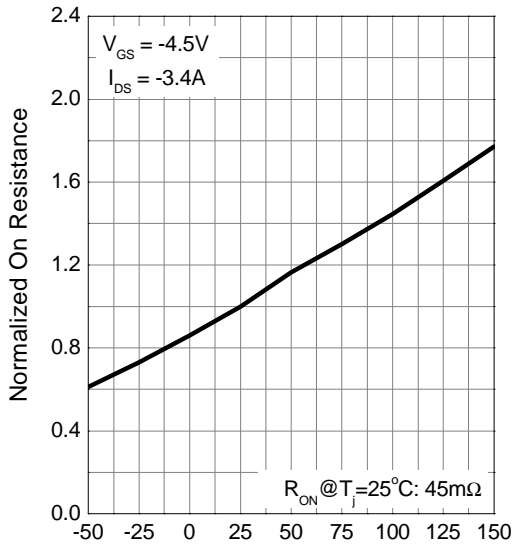

T_j - Junction Temperature (°C)

Source-Drain Diode Forward

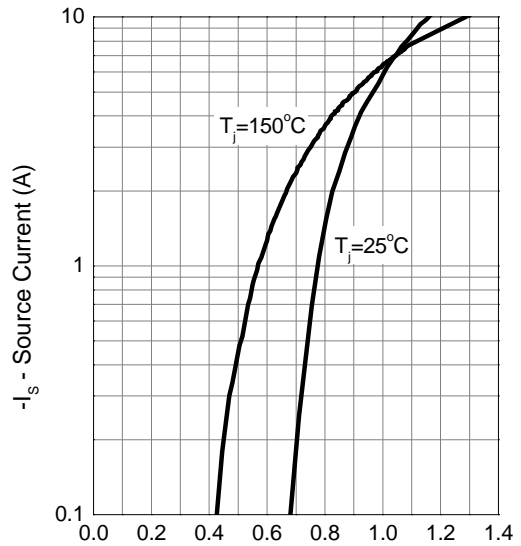

-V_{SD} - Source-Drain Voltage (V)

Capacitance

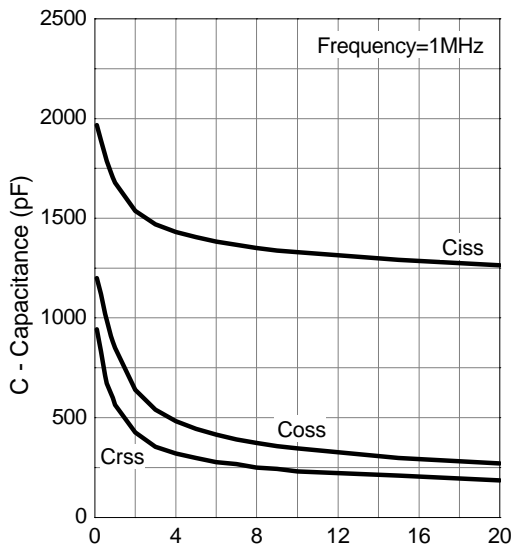

-V_{DS} - Drain-Source Voltage (V)

Gate Charge

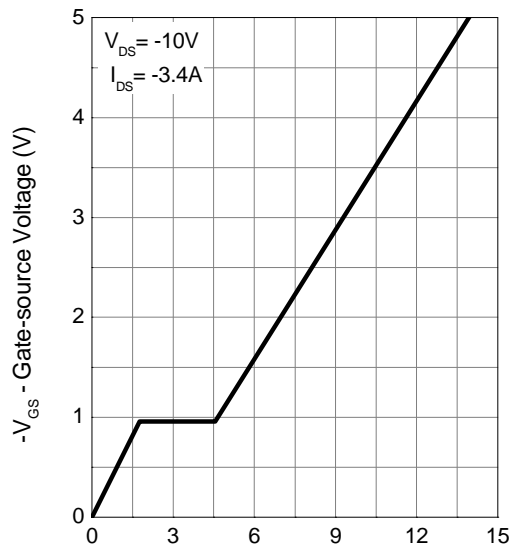

Q_G - Gate Charge (nC)

Package Information

SOP-8

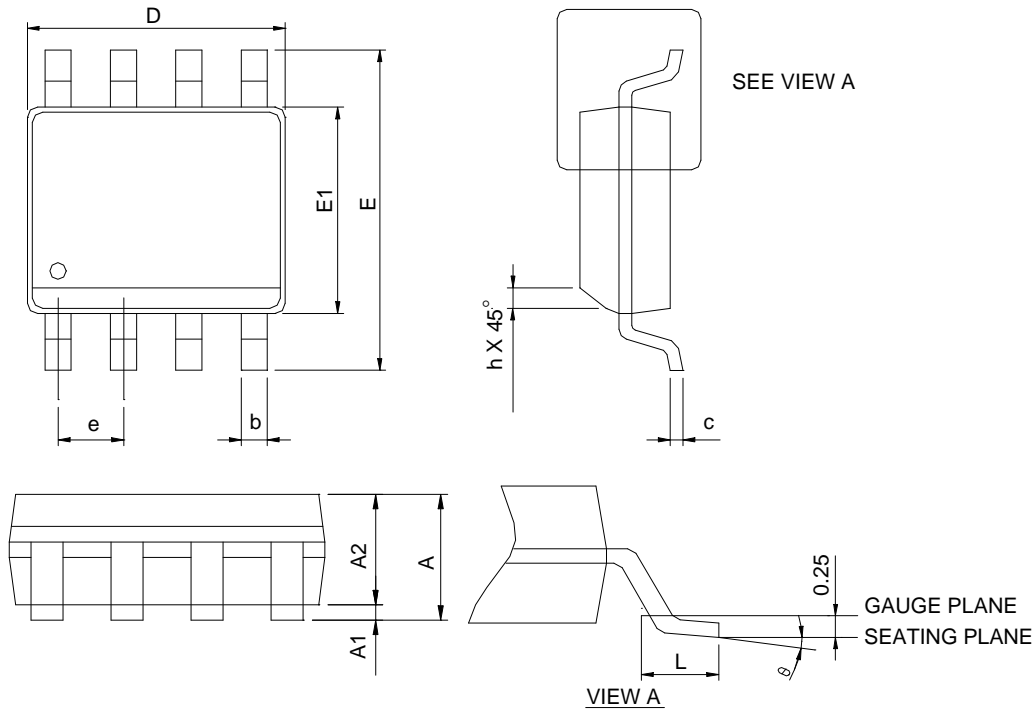

SYMBOL	SOP-8			
	MILLIMETERS		INCHES	
	MIN.	MAX.	MIN.	MAX.
A		1.75		0.069
A1	0.10	0.25	0.004	0.010
A2	1.25		0.049	
b	0.31	0.51	0.012	0.020
c	0.17	0.25	0.007	0.010
D	4.80	5.00	0.189	0.197
E	5.80	6.20	0.228	0.244
E1	3.80	4.00	0.150	0.157
e	1.27 BSC		0.050 BSC	
h	0.25	0.50	0.010	0.020
L	0.40	1.27	0.016	0.050
θ	0°	8°	0°	8°

- Note: 1. Follow JEDEC MS-012 AA.
 2. Dimension "D" does not include mold flash, protrusions or gate burrs. Mold flash, protrusion or gate burrs shall not exceed 6 mil per side.
 3. Dimension "E" does not include inter-lead flash or protrusions. Inter-lead flash and protrusions shall not exceed 10 mil per side.

Carrier Tape & Reel Dimensions

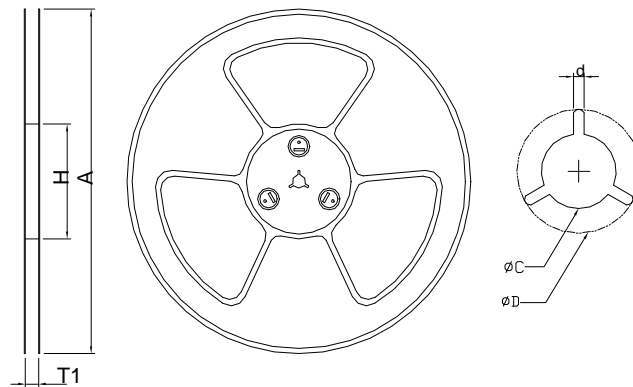
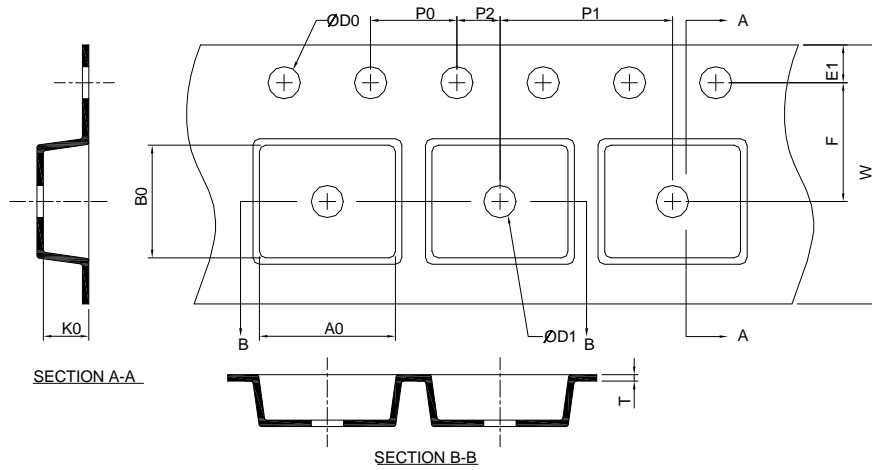

Application	A	H	T1	C	d	D	W	E1	F
SOP-8	330.0 ± 2.00	50 MIN.	12.4+2.00 -0.00	13.0+0.50 -0.20	1.5 MIN.	20.2 MIN.	12.0 ± 0.30	1.75 ± 0.10	5.5 ± 0.05
	P0	P1	P2	D0	D1	T	A0	B0	K0
	4.0 ± 0.10	8.0 ± 0.10	2.0 ± 0.05	1.5+0.10 -0.00	1.5 MIN.	0.6+0.00 -0.40	6.40 ± 0.20	5.20 ± 0.20	2.10 ± 0.20

(mm)

Devices Per Unit

Package Type	Unit	Quantity
SOP-8	Tape & Reel	2500

Taping Direction Information

SOP-8

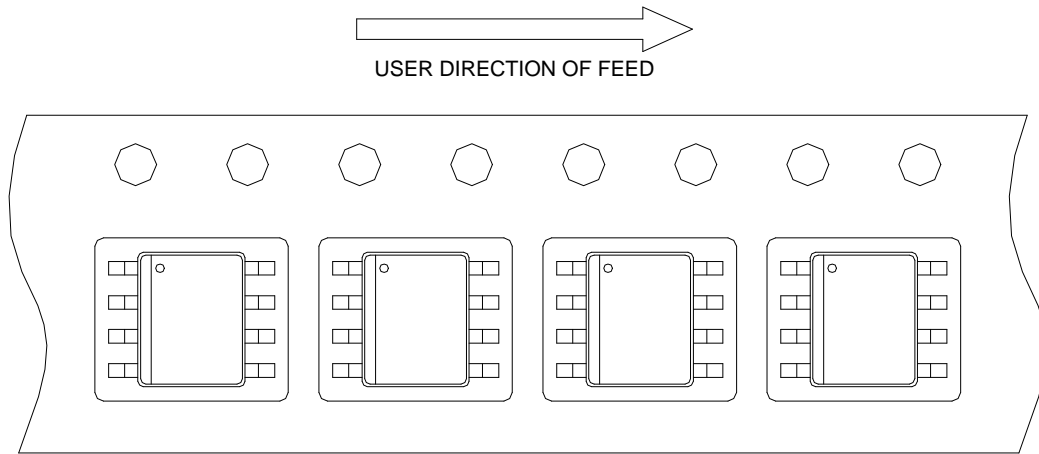

Reflow Condition (IR/Convection or VPR Reflow)

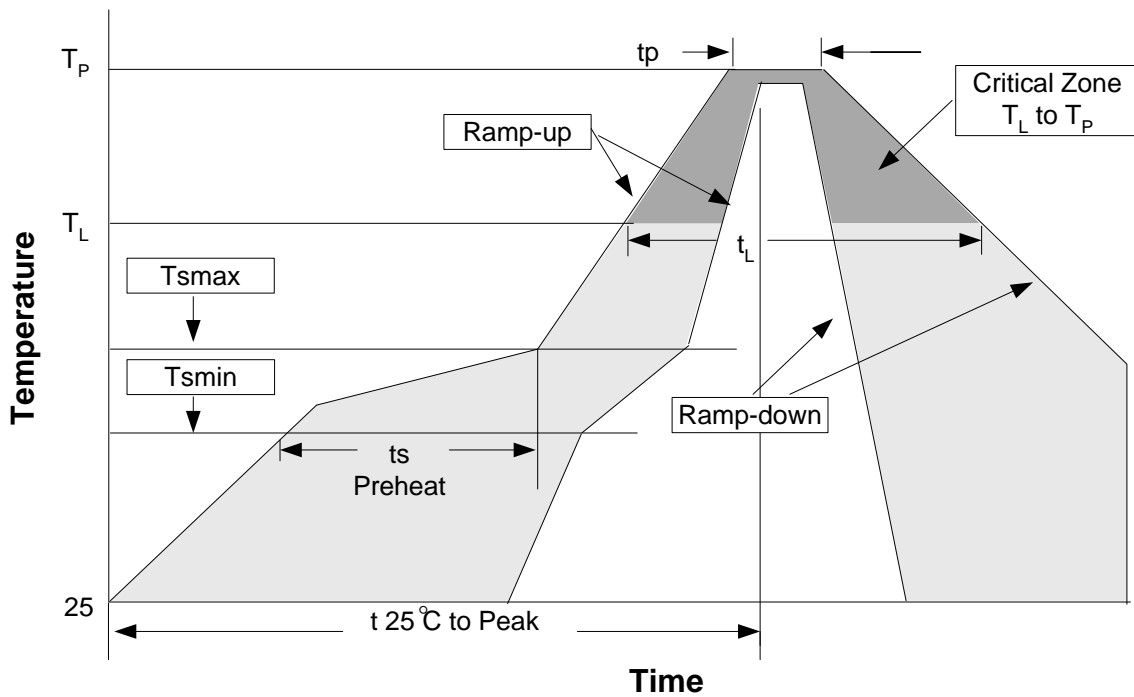

Reliability Test Program

Test item	Method	Description
SOLDERABILITY	MIL-STD-883D-2003	245°C, 5 sec
HOLT	MIL-STD-883D-1005.7	1000 Hrs Bias @ 125°C
PCT	JESD-22-B, A102	168 Hrs, 100%RH, 121°C
TST	MIL-STD-883D-1011.9	-65°C~150°C, 200 Cycles

Classification Reflow Profiles

Profile Feature	Sn-Pb Eutectic Assembly	Pb-Free Assembly
Average ramp-up rate (T _L to T _P)	3°C/second max.	3°C/second max.
Preheat - Temperature Min (T _{min}) - Temperature Max (T _{max}) - Time (min to max) (ts)	100°C 150°C 60-120 seconds	150°C 200°C 60-180 seconds
Time maintained above: - Temperature (T _L) - Time (t _L)	183°C 60-150 seconds	217°C 60-150 seconds
Peak/Classification Temperature (T _p)	See table 1	See table 2
Time within 5°C of actual Peak Temperature (tp)	10-30 seconds	20-40 seconds
Ramp-down Rate	6°C/second max.	6°C/second max.
Time 25°C to Peak Temperature	6 minutes max.	8 minutes max.

Note: All temperatures refer to topside of the package. Measured on the body surface.

Table 1. SnPb Eutectic Process – Package Peak Reflow Temperatures

Package Thickness	Volume mm ³ <350	Volume mm ³ ≥350
<2.5 mm	240 +0/-5°C	225 +0/-5°C
≥2.5 mm	225 +0/-5°C	225 +0/-5°C

Table 2. Pb-free Process – Package Classification Reflow Temperatures

Package Thickness	Volume mm ³ <350	Volume mm ³ 350-2000	Volume mm ³ >2000
<1.6 mm	260 +0°C*	260 +0°C*	260 +0°C*
1.6 mm – 2.5 mm	260 +0°C*	250 +0°C*	245 +0°C*
≥2.5 mm	250 +0°C*	245 +0°C*	245 +0°C*

*Tolerance: The device manufacturer/supplier **shall** assure process compatibility up to and including the stated classification temperature (this means Peak reflow temperature +0°C. For example 260°C+0°C) at the rated MSL level.

Customer Service

Anpec Electronics Corp.

Head Office :

No.6, Dusing 1st Road, SBIP,

Hsin-Chu, Taiwan, R.O.C.

Tel : 886-3-5642000

Fax : 886-3-5642050

Taipei Branch :

2F, No. 11, Lane 218, Sec 2 Jhongsing Rd.,

Sindain City, Taipei County 23146, Taiwan

Tel : 886-2-2910-3838

Fax : 886-2-2917-3838