

Panasonic
ideas for life

Programmable Controller

FP-X

Introducing a New Transistor Output Model
Pulse Output

4-Axis Integrated Control



2-Axis Linear
Interpolation
Simultaneously
in 2 Pairs!



14-point type



30-point type



60-point type

FP-X Programmable Controller
ARCT1B273E '06.8

New



AFPX-C60
(Add-on cassette attached)

▶ Ultra High-speed Processing

High-speed scan of 0.32 μs for a basic instruction
(1.9 ms scan time for 5 ksteps*¹)

The processing speed of 0.32 μsec , sufficient for a compact PLC, is even applicable when high-speed scanning is required.

*1: A 5-kstep program consisting of 35% basic instructions and 65% applied instructions (data transfer, four operations)

▶ Large Capacity with an Extra Margin

Program capacity of 32 ksteps with a sufficient comment area*²

The program capacity of 32 ksteps, exceeding the capacity of most compact PLCs, can flexibly handle a wide variety of applications requiring future equipment expansion.

*2: C14: 16 ksteps

▶ Great Expandability with a Wide Variety of Options

Max. I/O expansion of 300 points and further expansion with a function expansion cassette

The add-on cassette easily enables functional enhancements when slightly more features are to be added, while keeping costs down. The expansion FP0 adapter enables the connection of 3 additional FP0 expansion units.

High Security

Program protection with an 8-digit password and a function prohibiting uploads

USB-port Equipped*³

Easy direct connection with a PC via a commercial USB cable (AB type)

*3: Not provided with C14.

New Functions

- ▶ Easy-to-use Temperature Control Command (F356 EZPID)
- ▶ MEWTOCOL Master Function
- ▶ Ethernet Add-on Unit (Available Soon)
- ▶ Trace Function

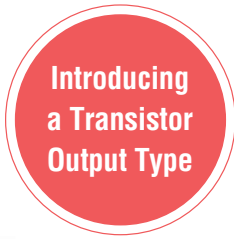

Programmable **FP-X** Controllers

4-axis pulse output in a compact body (C14 comes with 3 axes)

Simultaneous 2-axis linear interpolation is possible in two pairs

Servomotor and stepping motor control in production equipment has become increasingly diversified while requiring a greater number of axes – for example, electronic control for replacing cams, XY table + Z-axis control for cell-production and LCD alignment, 3D bending process of corrugated paper boxes and heat exchanger pipes, high-density coil winding operations etc. With such applications in mind, FP-X is a compact general-purpose PLC suited for small-scale equipment controls with its 4-axis pulse output built into the compact body, enabling multi-axis control in a very small space at a fraction of the equipment cost.



AFPX-C30
(Add-on cassette attached)





AFPX-C14
(Add-on cassette attached)

The Highly Expandable Lineup Satisfies All Kinds of Needs.

The flexible product lineup designed for rapidly responding to user needs provides a high level of satisfaction.

Product Lineup

Control Unit	Relay output	Transistor output																																												
 AFPX-C14R	Power supply (100 to 240 V AC) DC input: 8 (24 V DC) Relay output: 6 (250 V AC/2 A) Program capacity: 16 ksteps Potentiometer: 2	AFPX-C14TD DC power supply, Transistor output (NPN), Input: 8-point, Output: 6-point AFPX-C14T AC power supply, Transistor output (NPN), Input: 8-point, Output: 6-point AFPX-C14PD DC power supply, Transistor output (PNP), Input: 8-point, Output: 6-point AFPX-C14P AC power supply, Transistor output (PNP), Input: 8-point, Output: 6-point																																												
 AFPX-C30R	Power supply (100 to 240 V AC) DC input: 16 (24 V DC) Relay output: 14 (250 V AC/2 A) Program capacity: 32 ksteps Potentiometer: 2 Equipped with a USB communication port	AFPX-C30TD DC power supply, Transistor output (NPN), Input: 16-point, Output: 14-point AFPX-C30T AC power supply, Transistor output (NPN), Input: 16-point, Output: 14-point AFPX-C30PD DC power supply, Transistor output (PNP), Input: 16-point, Output: 14-point AFPX-C30P AC power supply, Transistor output (PNP), Input: 16-point, Output: 14-point																																												
 AFPX-C60R	Power supply (100 to 240 V AC) DC input: 32 (24 V DC) Relay output: 28 (250 V AC/2 A) Program capacity: 32 ksteps Potentiometer: 4 Equipped with a USB communication port	AFPX-C60TD DC power supply, Transistor output (NPN), Input: 32-point, Output: 28-point AFPX-C60T AC power supply, Transistor output (NPN), Input: 32-point, Output: 28-point AFPX-C60PD DC power supply, Transistor output (PNP), Input: 32-point, Output: 28-point AFPX-C60P AC power supply, Transistor output (PNP), Input: 32-point, Output: 28-point																																												
Expansion Unit																																														
 AFPX-E16R	DC input: 8 (24 V DC) Relay output: 8 (250 V AC/2 A) Remarks) Two or more E16R can't be connected serially because it can't supply the power to other units.	AFPX-E16T Transistor output (NPN), Input: 8-point, Output: 8-point AFPX-E16P Transistor output (PNP), Input: 8-point, Output: 8-point																																												
 AFPX-E30R	Power supply (100 to 240 V AC) DC input: 16 (24 V DC) Relay output: 14 (250 V AC/2 A) Remarks) Addition of up to 8 units is possible including E16R and EFP0.	AFPX-E30TD DC power supply, Transistor output (NPN), Input: 16-point, Output: 14-point AFPX-E30T AC power supply, Transistor output (NPN), Input: 16-point, Output: 14-point AFPX-E30PD DC power supply, Transistor output (PNP), Input: 16-point, Output: 14-point AFPX-E30P AC power supply, Transistor output (PNP), Input: 16-point, Output: 14-point																																												
Add-on Cassette	Communication cassette	Expansion FPO Adapter																																												
 AFPX-COM1	Communication cassette (RS232C 1 ch.)	 AFPX-EFPO Up to 3 FPO expansion units can be connected.																																												
 AFPX-COM2	Communication cassette (RS232C 2 ch.)																																													
AFPX-COM3	Communication cassette (RS485/422 selectable 1 ch.)																																													
AFPX-COM4	Communication cassette (RS485 1 ch + RS232C 1 ch.)																																													
 AFPX-COM5 (Avail. April 2007)	Communication cassette (Ethernet 1 ch + RS232C 1 ch.)																																													
	Application cassette	FPO Expansion Unit																																												
 AFPX-IN8	Input cassette (24 V DC, 8 input ch.)	<table border="1"> <thead> <tr> <th>Part number</th> <th>Specifications</th> </tr> </thead> <tbody> <tr> <td>FPO-E8X</td> <td>8 ch. DC input, MIL connector</td> </tr> <tr> <td>FPO-E16X</td> <td>16 ch. DC input, MIL connector</td> </tr> <tr> <td>FPO-E8YT</td> <td>8 ch. transistor output, MIL connector</td> </tr> <tr> <td>FPO-E8YRS</td> <td>8 ch. relay output, screw terminal block</td> </tr> <tr> <td>FPO-E16T</td> <td>16 ch. transistor output, MIL connector</td> </tr> <tr> <td>FPO-E16P</td> <td>16 ch. PNP output, MIL connector</td> </tr> <tr> <td>FPO-E32T</td> <td>16 ch. DC input, 16 ch. transistor output, MIL connector</td> </tr> <tr> <td>FPO-E32P</td> <td>16 ch. DC input, 16 ch. PNP output, MIL connector</td> </tr> <tr> <td>FPO-E8RS</td> <td>4 ch. DC input, 4 ch. relay output, screw terminal block</td> </tr> <tr> <td>FPO-E16RS</td> <td>8 ch. DC input, 8 ch. relay output, screw terminal block</td> </tr> <tr> <td>FPO-A21</td> <td>2 ch. analog input, 1 ch. output</td> </tr> <tr> <td>FPO-A80</td> <td>8 ch. analog input</td> </tr> <tr> <td>FPO-A04V</td> <td>4 ch. analog (voltage) output</td> </tr> <tr> <td>FPO-A04I</td> <td>4 ch. analog (current) output</td> </tr> <tr> <td>FPO-TC4</td> <td>4 ch. thermocouple input</td> </tr> <tr> <td>FPO-TC8</td> <td>8 ch. thermocouple input</td> </tr> <tr> <td>FPO-IOL</td> <td>I/O link unit</td> </tr> <tr> <td>FPO-CCLS</td> <td>CC-Link unit</td> </tr> <tr> <td>FPO-E32RS*1</td> <td>16ch DC input, 16ch relay output screw terminal block</td> </tr> <tr> <td>FPO-RTD6*1</td> <td>6ch RTD input</td> </tr> <tr> <td>FPO-DPS2*1</td> <td>PROFIBUS remote I/O unit</td> </tr> </tbody> </table>	Part number	Specifications	FPO-E8X	8 ch. DC input, MIL connector	FPO-E16X	16 ch. DC input, MIL connector	FPO-E8YT	8 ch. transistor output, MIL connector	FPO-E8YRS	8 ch. relay output, screw terminal block	FPO-E16T	16 ch. transistor output, MIL connector	FPO-E16P	16 ch. PNP output, MIL connector	FPO-E32T	16 ch. DC input, 16 ch. transistor output, MIL connector	FPO-E32P	16 ch. DC input, 16 ch. PNP output, MIL connector	FPO-E8RS	4 ch. DC input, 4 ch. relay output, screw terminal block	FPO-E16RS	8 ch. DC input, 8 ch. relay output, screw terminal block	FPO-A21	2 ch. analog input, 1 ch. output	FPO-A80	8 ch. analog input	FPO-A04V	4 ch. analog (voltage) output	FPO-A04I	4 ch. analog (current) output	FPO-TC4	4 ch. thermocouple input	FPO-TC8	8 ch. thermocouple input	FPO-IOL	I/O link unit	FPO-CCLS	CC-Link unit	FPO-E32RS*1	16ch DC input, 16ch relay output screw terminal block	FPO-RTD6*1	6ch RTD input	FPO-DPS2*1	PROFIBUS remote I/O unit
Part number	Specifications																																													
FPO-E8X	8 ch. DC input, MIL connector																																													
FPO-E16X	16 ch. DC input, MIL connector																																													
FPO-E8YT	8 ch. transistor output, MIL connector																																													
FPO-E8YRS	8 ch. relay output, screw terminal block																																													
FPO-E16T	16 ch. transistor output, MIL connector																																													
FPO-E16P	16 ch. PNP output, MIL connector																																													
FPO-E32T	16 ch. DC input, 16 ch. transistor output, MIL connector																																													
FPO-E32P	16 ch. DC input, 16 ch. PNP output, MIL connector																																													
FPO-E8RS	4 ch. DC input, 4 ch. relay output, screw terminal block																																													
FPO-E16RS	8 ch. DC input, 8 ch. relay output, screw terminal block																																													
FPO-A21	2 ch. analog input, 1 ch. output																																													
FPO-A80	8 ch. analog input																																													
FPO-A04V	4 ch. analog (voltage) output																																													
FPO-A04I	4 ch. analog (current) output																																													
FPO-TC4	4 ch. thermocouple input																																													
FPO-TC8	8 ch. thermocouple input																																													
FPO-IOL	I/O link unit																																													
FPO-CCLS	CC-Link unit																																													
FPO-E32RS*1	16ch DC input, 16ch relay output screw terminal block																																													
FPO-RTD6*1	6ch RTD input																																													
FPO-DPS2*1	PROFIBUS remote I/O unit																																													
 AFPX-TR8	Output cassette (NPN transistor 0.3 A, 8 output ch.)																																													
 AFPX-AD2	Analog input cassette (12-bit non-insulated 0 to 10 V/0 to 20 mA, 2 ch.)																																													
 AFPX-PLS	Pulse I/O cassette (High-speed counter input: single phase 80 kHz 2 ch., 2-phase 30 kHz 1 ch.) (Pulse output: 1 axis 100 kHz < cw/ccw, pulse + sign >) *Cannot be built into a transistor output type																																													
 AFPX-MRTC	Master memory cassette with a real-time clock (32 ksteps program memory + real-time clock in year/month/day/hour/minute) *Real-time clock needs an option battery. (Real-time clock → Calendar timer)																																													

*1 Provided from Panasonic Electric Works Europe AG

FP-X Name and Function of Each Part

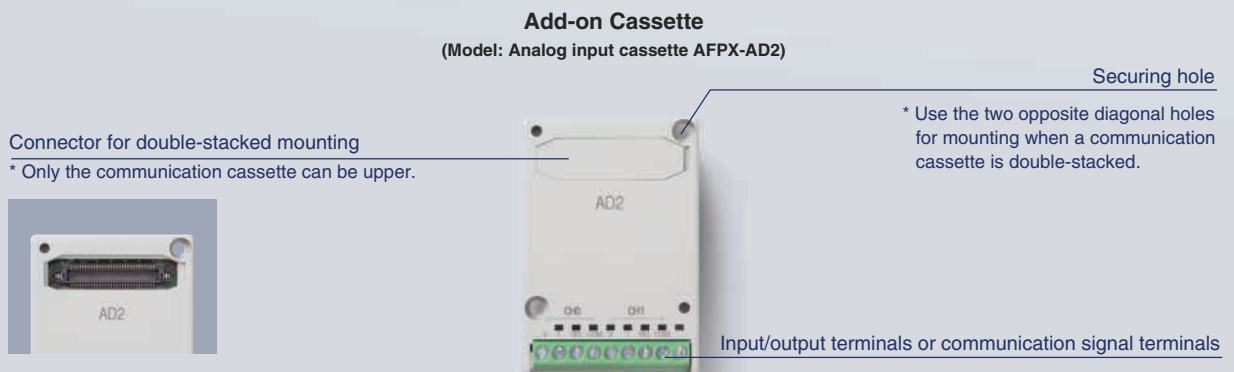
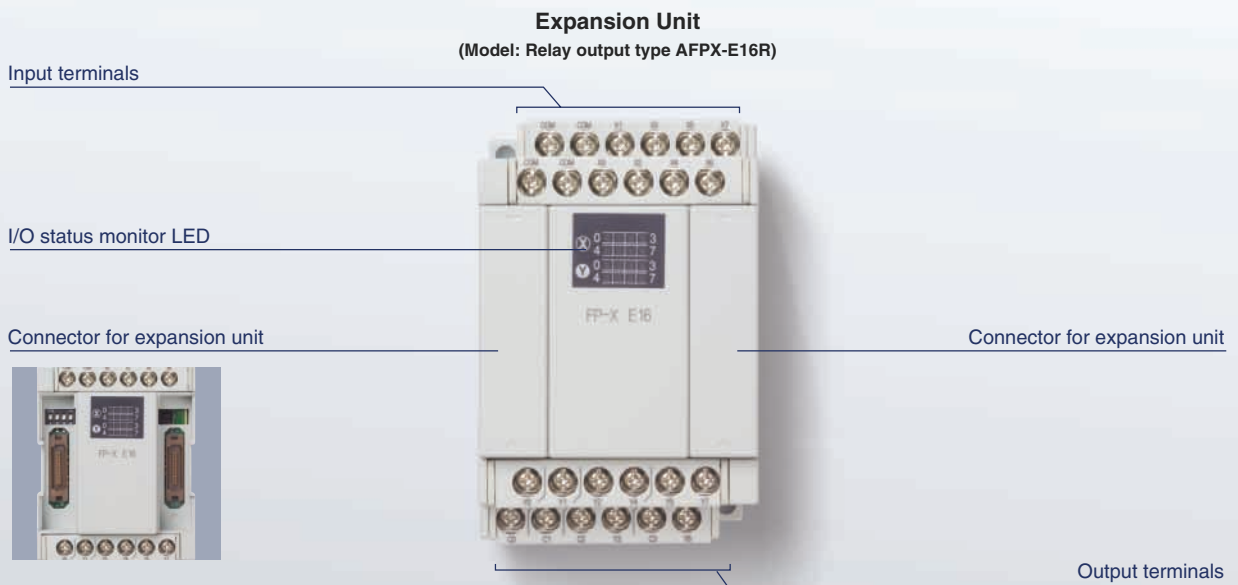
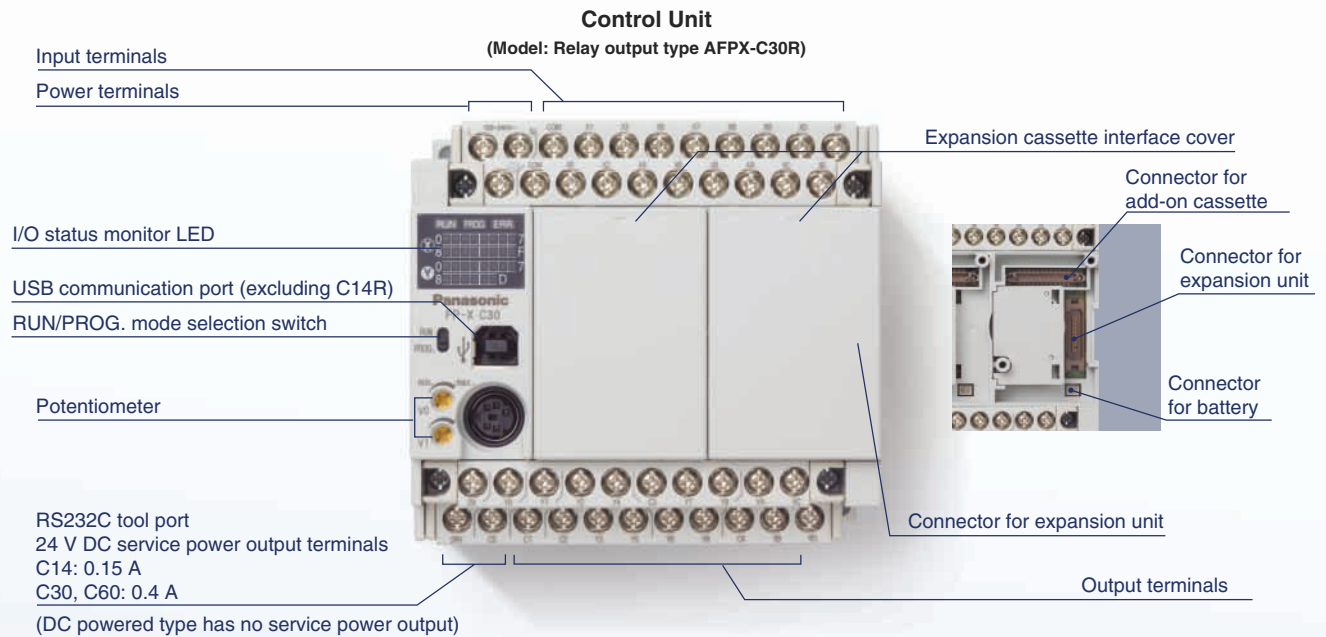

Positioning

FP-X perfectly fits the need for low cost “multi-axis positioning control in small-scale equipment”

■ Built-in 4-axis Pulse Output (Transistor Output Type)

The transistor output type C14 comes with 3-axis while C30/60 comes with 4-axis pulse output inside the control unit. The multi-axis control, which previously required a higher-level PLC or additional positioning unit, or two or more PLC units, can now be achieved with only one FP-X transistor output type unit in a small space at a low cost. In addition, as this type does not require a pulse I/O cassette needed for a relay output type, other function expansion cassettes such as communication or analog input can be attached for more diversified applications.

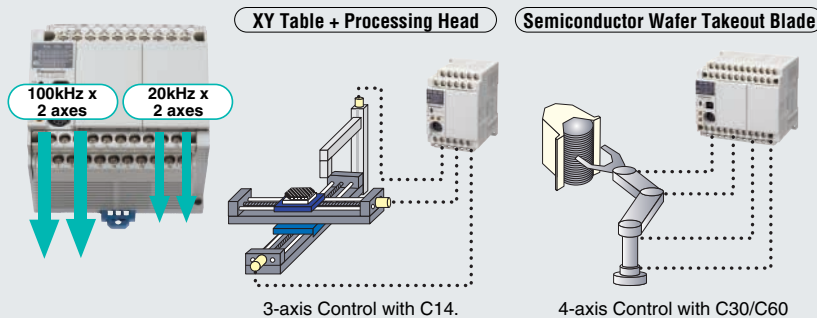

Item	Specification
Pulse Output Max Frequency	C14: 100kHz(CH0,1), 20kHz(CH2) C30,C60: 100kHz(CH0,1), 20kHz(CH2,3)
Output Type	CW+CCW, Pulse + Direction Output
Function	Trapezoidal control, multi-stage operation, jog operation, origin return, 2-axis linear interpolation

● The relay output type can control two axes by using the expansion cassettes

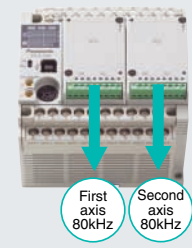

Pulse output up to 2-axis 80kHz is possible by loading two pulse I/O cassettes (AFPX-PLS). Also capable of performing 2-axis linear interpolation. **Pulse I/O cassette doesn't work with control unit transistor output type.**

■ 2-axis Linear Interpolation Simultaneously in two Sets (Transistor Output Type)

2-axis linear interpolation refers to moving a robot arm or equipment head diagonally on a straight line by simultaneously controlling two motor shafts. It is used for palletizing, component pick and place, XY table control, contour cutting of a PC board etc. FP-X transistor output type is capable of simultaneously controlling 2-axis linear interpolation, for the first time in the industry with a compact pulse-output PLC. This unit drastically expands the range of applications along with the added convenience of programming by using the linear interpolation commands F175 (SPSH).

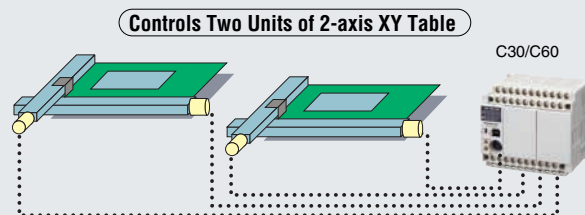
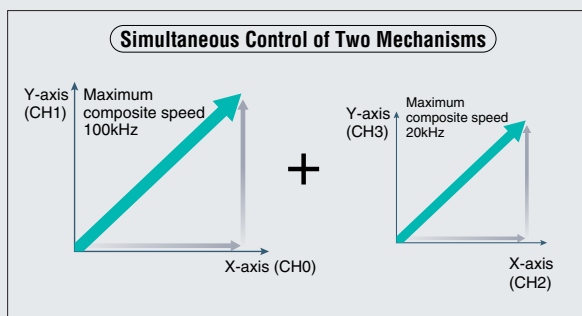

● The relay output type is also capable of 2-axis linear interpolation.

By adding two pulse I/O cassette units, linear interpolation is possible at the maximum composite speed of 80kHz. The command used for this unit is F175 (SPSH), same as that for the transistor output types.

■ High-Speed Counters – Eight Built-in Sets

Eight single-phase or four dual-phase sets (X0-X7)

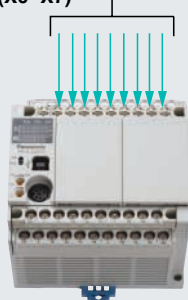

Model Type	Output Mode	Pulse Output (four axes)	One ch in use	All channels in use
Transistor Output Type	Single Phase	During Halt	100kHz	50kHz × 4ch + 10kHz × 4ch
		During Operation	35kHz	25kHz × 4ch + 10kHz × 4ch
	Dual Phase	During Halt	35kHz	25kHz × 2ch + 5kHz × 2ch
		During Operation	15kHz	10kHz × 2ch + 5kHz × 2ch
Relay Output Type	Single Phase	During Halt	10kHz	10kHz × 8ch
		During Operation	10kHz	10kHz × 8ch
	Dual Phase	During Halt	5kHz	5kHz × 4ch
		During Operation	5kHz	5kHz × 4ch

When adding a pulse I/O cassette to the relay output type, two high-speed counter sets can be added to every cassette. Please refer to the user manual for counter specification.

Usability

The enhanced functionality expands the ranges of applications, while improving the ease of use.

■ Securing 0.5A in every transistor output even when all output ports are ON.

The transistor output type is not limited by the control capacity of each common line. Every output port can secure 0.5A even when all output ports are ON for any basic unit C14, C30, C60 as well as the expansion units E16 and E30 (at 25° C) – Sufficient capacity for high-load switching such as LED type signal tower etc.



LED signal tower

Transistor Output Capacity 0.5A
(Even when all output ports are ON)

■ Equipped with a Sampling Trace Function – Smart Solution for Program Debugging

(Available from Ver. 2.0 of the transistor type and relay output types)

The sampling trace function enables the user to monitor a change of I/O condition or data register value in a very short time interval – an efficiency tool for debugging a ladder program.

The shortest sampling interval of the normal time-chart monitor is 10ms with the FPWIN GR or FPWIN PRO, but monitoring in much shorter intervals is often required during debugging operations. The sampling trace function enables data accumulation of any 16 contact data and 3 data register values once or several times within a scan time. Reading out these data through the FPWIN GR or FPWIN PRO enables the user to confirm an instantaneous change of status by time on the time-chart monitor.

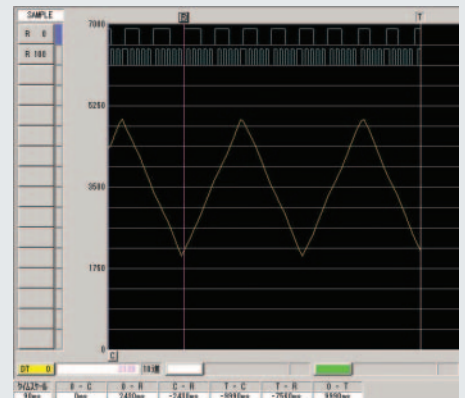

(Normal Time-Chart Monitor)



(Sampling Trace)



Invisible changes become visible!

■ The communication cassette (Ethernet Type) will be April 2007.

Using this option, you can monitor the data in FP-X on the PCWAY through the existing Ethernet, or remotely upload/download a program.

AFPX-COM5

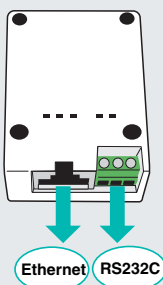

Interface	Ethernet (COM1)	10BASE-T, 100BASE-TX, TCP/IP	
	RS232C (COM2)	3-wire, Asynchronous, Max115.2kbps	
Ethernet Communication Mode (1:1 communication)	Computer Link	General communication (server)	General communication (client)
	PCWAY, FPWIN GR/PRO etc.	Wait for a connection by the partner	Connect to the specified partner

FP-X ← → FP-X

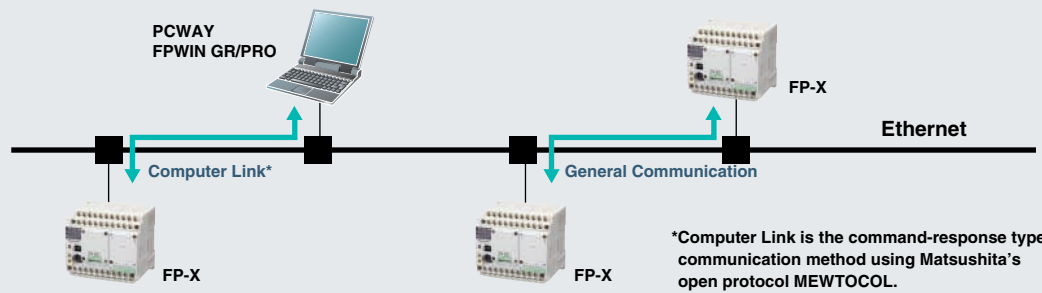

*Computer Link is the command-response type communication method using Matsushita's open protocol MEWTOCOL.

Temperature Control

The high-level PID control easily achieves high-speed, high-accuracy multi-point temperature control.

■ New PID Command (F356 EZPID) Produces a Temperature Control Program only in a Single Line.

●The application of PLC-based temperature control has been expanding such as multi-level temperature control, timer-controlled temperature control, and a temperature control relative to a variable based on a data computation results etc. By using the new PID command (F356 EZPID), a PID control program can be drastically simplified and the PLC-based temperature control, which was previously thought to be difficult by a PLC, can easily be achieved. The example on the right, a simple uniform temperature control, enables a surprisingly easily PID control with a single line command by using a F356 command combined with a touch-panel operation.

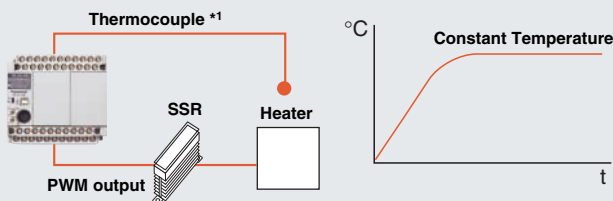

*1 Thermocouple connection requires FP0 Thermocouple Unit.

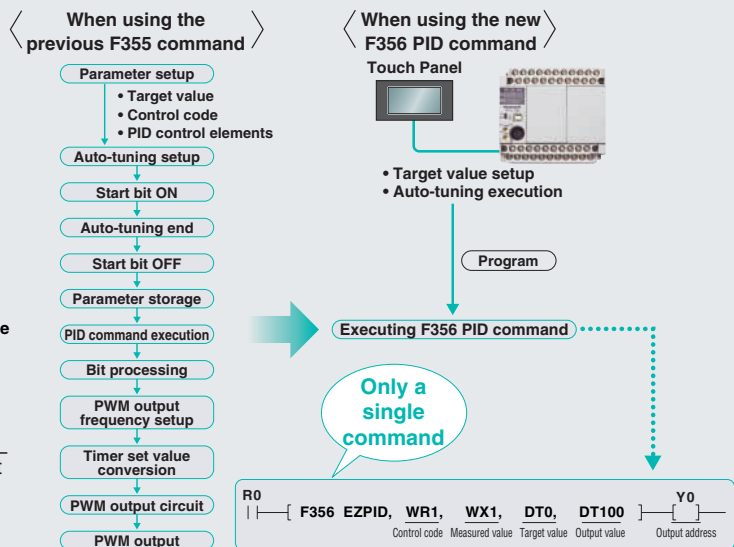

■ Multi-point PID control

- High-accuracy PID control is possible by adopting a sophisticated algorithm and floating-point operations.
- Higher accuracy is obtained by ultra high-speed computations in a 32 μ s/loop. For example, a 16-loop control only adds a scan time of 0.5 ms by ensuring minimum impact on the tact time.
- The simultaneous multi-point auto-tuning simplifies complex parameter setting.
- The high-speed control PI-D*1 mode and overshoot suppression I-PD*2 mode are available for selection according to the intended application.
- By combining with a sequence control, the parameters (Kp, Ti, Td, etc.) can be changed during a PID control execution, thereby enabling optimum temperature control in each stage including start up, mid-range, and convergence. The ability to change the target value easily enables multi-step temperature control, which was difficult only with temperature controllers. In addition, the multi-point temperature control enables the centralized control of multiple temperature controllers with a single FP-X for unified data management.

*1 Derivative type

*2 Proportional-derivative type

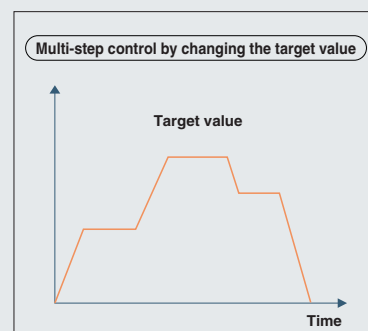
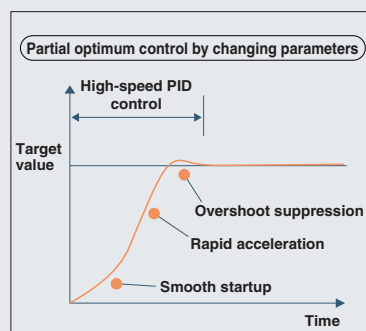
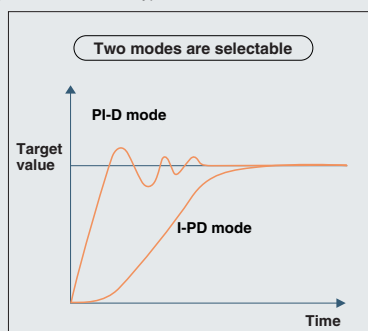
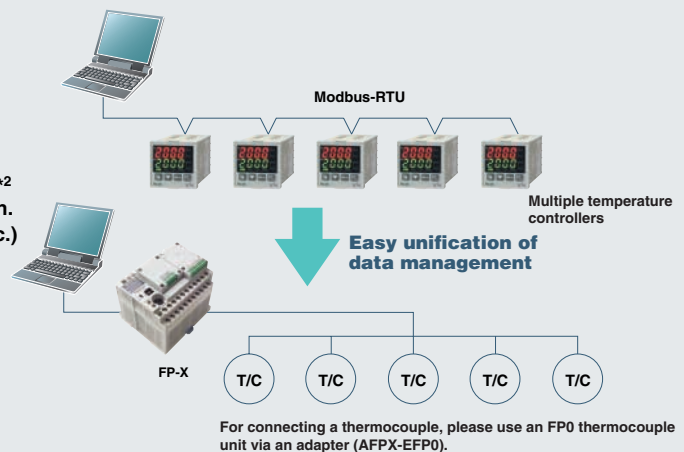

High capacity/High speed

The high-level basic performance provides sufficient room for future equipment expansion as well as a rich variation.

■ Abundant program capacity - **32** ksteps (16 ksteps for C14)

The program capacity of 32 ksteps, exceeding the capacity of most compact PLCs, can flexibly handle a wide variety of applications requiring future equipment expansion. An adequate comment area has of course been reserved. Free comment entry makes the program easy to understand during verification.

- Separate memory areas reserved for program memory and comments do not cause a reduction of program capacity when comments are entered.
- 100,000 I/O comment items, 5,000 lines of line-space comments, 5,000 lines of remark comments - All comments are stored in the FP-X simultaneously with the program.

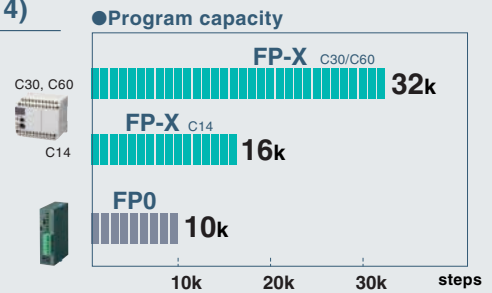

■ Ultra high-speed scan at **0.32** μsec for instruction processing

High-speed processing is often required for small-scale equipment control such as serial data communication, network construction or PID temperature control. High-speed scanning at 0.32 μsec/step (basic instruction) easily meets such requirements.

(Ex.) In the case of a 5-kstep program consisting of 35% basic instructions and 65% applied instructions,
 → Scan time: **1.9 ms** (measured time)

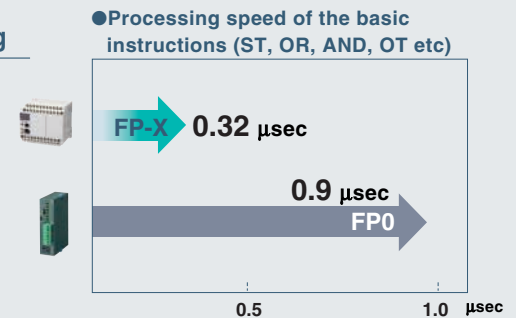

■ Abundant number of I/O points - Maximum **300** (Up to 382 points possible by using FP0 expansion units and add-on cassettes)

When the user cannot predict the number of I/O points required in the future for his machine or equipment, he is uncertain in selecting a PLC model. FP-X solves user concerns with a maximum of 300 I/O channels. The number can even be increased up to 382 points by using the add-on cassettes and FP0 expansion units.

- Expansion units (E16R, E30R, EFP0) can be connected up to eight units.

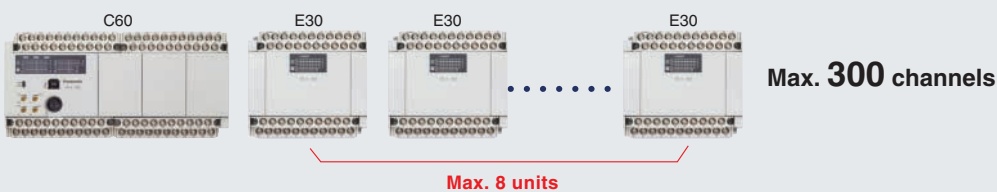

- Two or more E16 can't be connected serially.
- E16 can be sandwiched with E30*

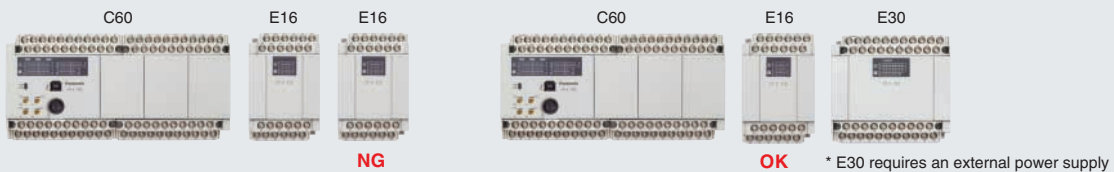

- Connection by using the cable included in each expansion unit.



The units can be tightly mounted adjacent to each other with the cable bent inside between the units for saving space.

Expansion

"Require slightly more functions", "Want to add functions to the existing equipment"
- The rich variety of expansion boards helps solve these requirements.

■ The **Add-on cassette** easily adds small quantities of functions and I/O points.

The add-on cassette can be mounted onto the control unit easily.

Up to 2 cassettes on C14 or up to 3 cassettes on C30/C60 can be mounted.

Only communication cassette can be double-stacked upper side. (Communication cassette should be only one totally.)

Note) Please refer to the manual for the number of mountable units and position.

Add-on Cassette		Specifications		
Application Cassette	DC input AFPX-IN8	24 V DC input, 8 ch., bidirectional input (sync/source)		
	Transistor output AFPX-TR8	NPN, 8 ch., 0.3 A		
	Pulse I/O AFPX-PLS	High-speed counter input → Single-phase 2 ch. 80 kHz or two-phase 1 ch. 30 kHz Pulse output → Single-axis 100 kHz (CW/CCW, Pulse+Sign)		
	Cannot be used with a transistor output type			
	Analog input AFPX-AD2	2 ch., 12 bits (non-insulated), 2 ms/2 ch. 0 to 10 V or 0 to 20 mA		
Master memory AFPX-MPTC		32-kstep program storage and transfer Calendar timer		
Communication Cassette	AFPX-COM1	RS232C	1 ch.	
	AFPX-COM2	RS232C	2 ch.	
	AFPX-COM3	RS485/RS422 selectable ^{*1}	1 ch.	
	AFPX-COM4	RS485 + RS232C ^{*1}	1 ch. each	
	AFPX-COM5	Ethernet 1ch + RS232C 1 ch (Available April 2007)		

NEW

*1: Each of RS485 and RS422 is an insulated type.



Easily removable
(Two screws to secure the unit)

■ When further expansion or functions are required, use the existing **FP0 expansion unit**.

All control units can be expanded by up to 3 FP0 expansion units via an adapter.

Applications can be expanded by using [Transistor outputs], [Analog input/outputs], [Thermocouple input] and [I/O link (network)].

When further expansion or functions are required, use the existing FP0 expansion unit.

* Only one expansion FP0 adapter unit can be attached to a control unit.
Up to 7 FP-X expansion units can be used when the expansion FP0 adapter is attached.



Max. 7 units (210 points)

Max. 96 points



Expansion FP0 adapter (AFPX-EFP0)

Product number	Specifications	Product number	Specifications
FP0-E8X	8 ch. DC input, MIL connector	FP0-A21	Analog 2 ch. input, 1 ch. output
FP0-E16X	16 ch. DC input, MIL connector	FP0-A80	Analog 8 ch. input
FP0-E8YT	8 ch. transistor output, MIL connector	FP0-A04V	Analog (voltage) 4 ch. output
FP0-E8YRS	8 ch. relay output, screw terminal block	FP0-A04I	Analog (current) 4 ch. output
FP0-E16YT	16 ch. transistor output, MIL connector	FP0-TC4	Thermocouple 4 ch. input
FP0-E32T	16 ch. DC input, 16 ch. transistor output, MIL connector	FP0-TC8	Thermocouple 8 ch. input
FP0-E8RS	4 ch. DC input, 4 ch. relay output, screw terminal block	FP0-IOL	I/O link unit
FP0-E16RS	8 ch. DC input, 8 ch. relay output, screw terminal block	FP0-CCL	CC-link unit
		FP0-E32RS ^{*2}	16ch DC input, 16ch relay output screw terminal block
		FP0-RTD6 ^{*2}	6ch RTD input
		FP0-DPS2 ^{*2}	PROFIBUS remote I/O unit

*2 Provided from Panasonic Electric Works Europe AG

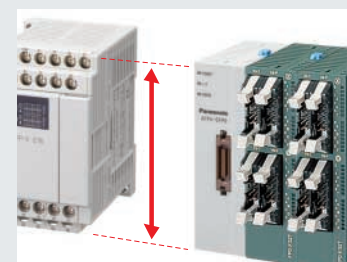

The unified unit height of 90 mm makes the panel surface look clean.

Network

Different types of equipment need to be linked – FP-X flexibly meet such requirements.

MEWTOCOL Master Function Has Been Added

By using the newly added MEWTOCOL master function for automatically generating MEWTOCOL (Matsushita Open Protocol) commands, serial communication with MEWTOCOL compatible units such as PD50, KT4H, KW4H etc becomes substantially easier.

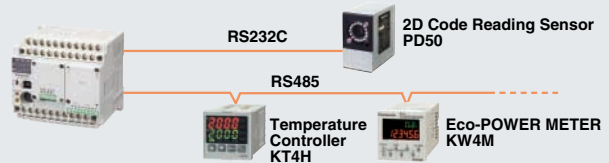

Up to 3 serial communication ports can be used at once.

The use of a communication cassette provides up to 3 serial communication ports.

Usable interfaces include RS232C, RS485, RS422, and USB.

*The RS232C tool port can be used as a general-purpose serial communication port.

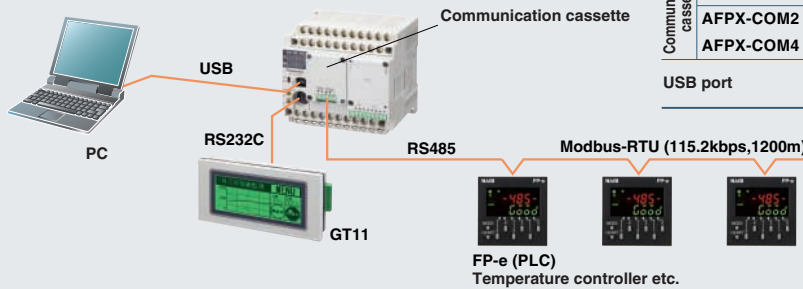

Communication Port			
RS232C tool port		Always used	
Communication cassette	AFPX-COM1 (RS232C 1 ch.)	Always used (Port No. COM1)	
	AFPX-COM3 (RS485/422 selectable 1 ch.)		
	AFPX-COM2 (RS232C 2 ch.)	1st ch.	
	AFPX-COM4 (RS485+RS232C)	2nd ch.	Switch-selectable (Port No. COM2)
USB port		Default setting: USB port use	

PLC Link

The MEWNET-W0 allows program-free links of up to 16 PLC units such as FP2/2SH or FPΣ. The distributed control system allows efficient model selection.

- Simple setting of the number of linked units, linked relays, and starting area address of the own station by using FPWIN GR/Pro allows sharing of contact information and data without programming.
- The transfer rate of 115.2 kbps, the highest rate for a compact model.
- A transfer distance of 1200 m, the longest distance for a compact model.
- FP-X and FPΣ allow a change of the station number by programming (SYS instruction).

Item	Specifications
Number of stations	16 stations
Transmission speed	115.2 kbps
Transmission distance	1200 m
Shared data	128 words (data register), 64 words (contacts)
Communication method	Floating master

FP-X requires a communication cassette (AFPX-COM3 or AFPX-COM4)
 FP2/2SH requires a multi-communication unit (AFP2465, AFP2805)
 FPΣ requires a communication cassette (AFPG803, AFPG806)

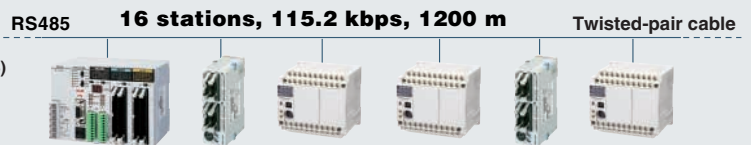

Modbus* Compatibility

Compatible with both the master and slave of the Modbus* RTU, the world's de-facto standard
 Great performance is expected for air-conditioning, temperature controls etc.

* Protocol developed by the Modicon Inc. of the United States

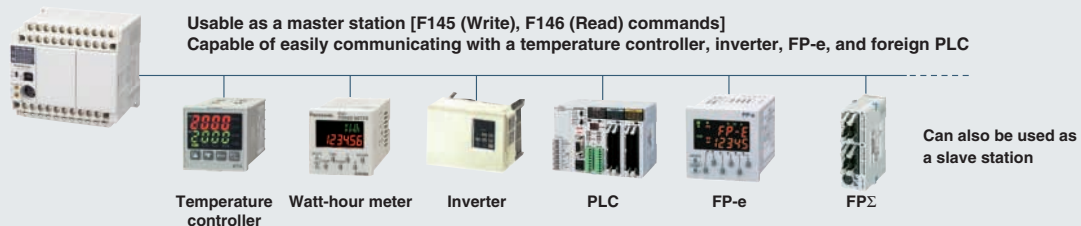

Another available application

When 17 or more FP-X units need to be linked, the use of a Modbus instead of a MEWNET-W0 can accommodate up to 99 FP-X units. Because each FP-X can be a master or slave, a multi-master link can be constructed by passing a token from a user program.

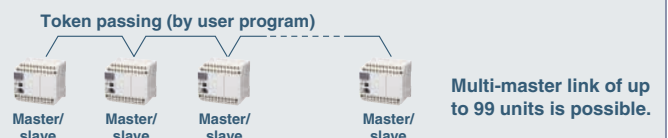

Program protection

Protects your important program by preventing illegal copies

Program upload is easily prohibited by tool software FPWIN.

- Reading a program from the PLC main unit is virtually impossible.
- In the upload-prohibited condition, program transfers to the master memory are also prohibited.
- Release of an upload-prohibited condition is possible with a forced release accompanied by a program deletion.
- Program updates are easily carried out by transferring the program in the master memory to FP-X even during an upload-prohibited condition. The transferred program in FP-X is setup with the same upload prohibition and permission conditions used in the master memory.



Items possible during an upload-prohibited condition	Program download from a PC	Forced input/output (Original program is required)
	Data transfer from the master memory	Ladder monitor (Original program is required)
Items impossible during an upload-prohibited condition	Change of data monitor/resistor value	Rewrite during RUN mode (Original program is required)
	Contact monitor	
	Time chart monitor	
	Program upload to a PC	Password protection
	Data transfer to the master memory	

More secure eight-character password can be used along with the previous four-character password.

- The combination of upper and lower case alphanumeric characters produces 218 trillion combinations. In addition, after three consecutive entry failures, a power reset is required for password release.

Adaptability

High versatility and rich functionality provides “peace of mind” and “flexibility”.

An expensive USB conversion adapter/cable is not necessary for connecting a PC to the PLC by using a standard USB port.*

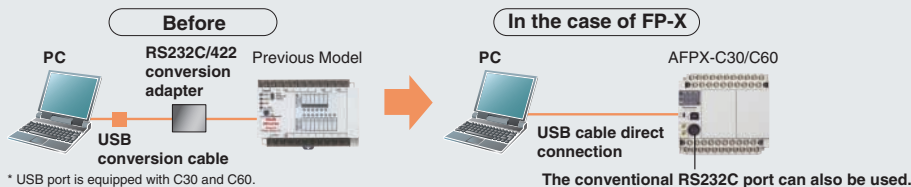

The master memory makes a program transfer easy and a real-time clock is equipped also

- The built-in 1 MB flash-ROM can store a 32-kstep program as well as the comments and FPWIN Pro source file.
- Program update in a remote location is easy by simply sending master memory for local installation.
- As the master memory stores the password information, password protection can be applied for program transmission. Similarly, upload prohibition/permission can be setup.
- The built-in real-time clock enables periodical repeated control and periodical data logging.

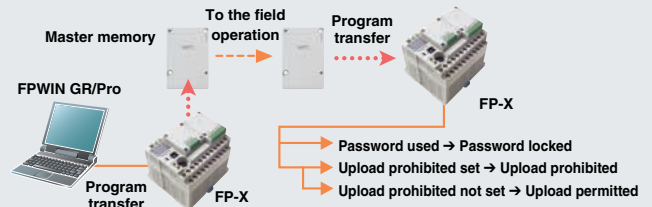

No need for program backup – easy maintenance

- The programs and comments are stored in flash ROM, requiring no backup batteries.
- A backup battery is provided for data and real-time clock (AFPX-BATT) One battery for C14, two for C30 and three for C60 can be attached. A two-battery installation can operate for a long time (10 years or more) without maintenance. (Real-time clock doesn't work without a battery.)



FROM data storage

- FP-X can store a program, comments, a total of 55 words of data, and bit setting values in a flash memory without a battery. All of the data and bits can be stored by adding optional batteries, but writing into a flash ROM is possible without a battery by using applied instructions (F12, P13). Perfectly suited for data storage of the setup values and recipes modified several times a day.

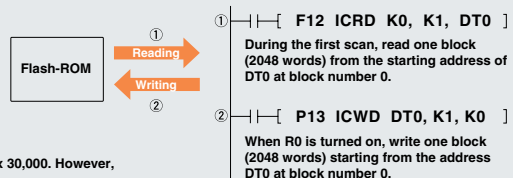

* The limitation in a flash ROM designates the number of rewrites to be 10,000, or the feasible number to be approx 30,000. However, rewriting every second will generate a memory failure within a few hours.

Programming

Note: Product names and company names in this chart are trademarks or registered trademarks of the respective companies.

Control FPWIN GR for Windows

The ladder programming software for FP series – highly operational software tool for maximizing convenience in the field.

■ Features

1. Easy field operations not requiring the use of a mouse for data entry, search, writing, monitoring and timer changes, all carried out only from the keyboard.
2. Allows standard operations in Windows, such as Copy & Paste, etc.
3. All FP series PLCs are supported. The software assets produced by using Ver. 4 or Ver. 3 of NPST-GR are usable.
4. Easy programming with wizard functions.
5. Communication with OPC Server, CommX, GTWIN, PCWAY simultaneously through the same port.

■ Operational Environment

OS	Windows95 (OSR2 or higher)/98/Me/NT (Ver. 4.0 or later)/2000/XP
Hard disk capacity	At least 40 MB
CPU	Pentium 100 MHz or higher
Onboard memory	At least 64 MB (depends on OS)
Screen resolution	At least 1024 × 768
Display colors	High color (16-bit or higher)
Applicable PLC	FP-X/FP-e/FP0/FPΣ/FP2/FP2SH
Compatible FP-X version	Relay output type: Ver.2.50 and after Transistor output type: Ver.2.70 and after

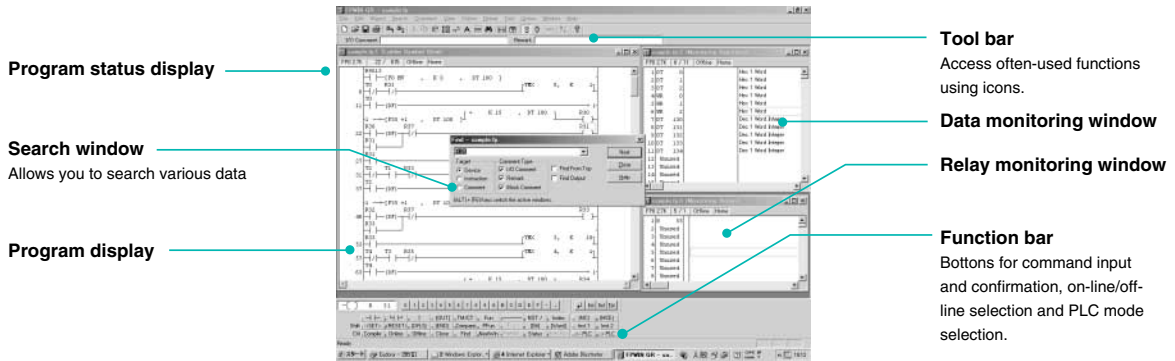

Function instruction list

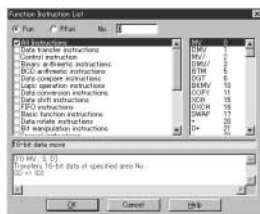

Classified by type, function instructions can be selected from the displayed list. (Simple help included.)

I/O comment edit function

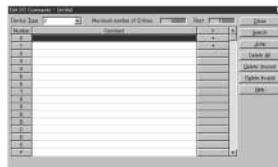

Successive I/O comments can be input for each device type. Data from Excel and other applications can be copied and pasted via the clipboard.

Status display



Displays information concerning PLC usage situation and settings, and detailed information when an error occurs.

Text Compiler



This software is for importing and exporting programs created in text format to and from FPWIN GR. Programs created on the PLC of another company can be edited as text and then be transferred to the FP Series without difficulty.

Text command input mode

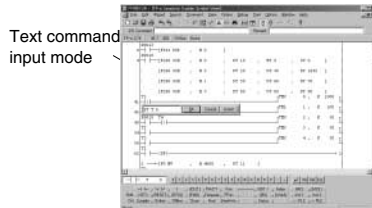

A ladder diagram is displayed as a mnemonic code is entered from the keyboard.

■ Accompanying Tools

● Data Editor

This software for the PC is for reading and writing data stored in the memory of FP Series main unit or on an IC card. If a large data table is required in a PLC, the data can be created and edited on a PC and then download to the PLC.

● Modem connection

Communication via modem is easy with FP Series units in isolated locations.

● Wizard function

A Wizard function included in FPWIN GR since versions 2.2 can automatically generate ladder programs by simply entering and selecting required items in the dedicated screen. It can be used to assist in positioning, PID instruction input, and FP-e screen display instruction input.

● Personal preference settings

It is possible to switch among preference settings for FPWIN GR, Data Editor and Text Compiler that are set up for different individuals.

Programming

Note: Product names and company names in this chart are trademarks or registered trademarks of the respective companies.

Control FPWIN Pro (IEC61131-3 compliant Windows version software)

Compliant with international standard IEC61131-3
Programming software approved by PLC Open

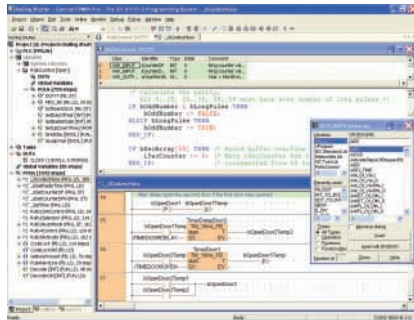
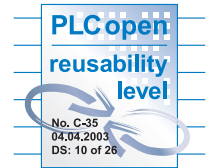

■ Features

1. Five programming languages can be used.

Programming can be done using the language most familiar to the developer or using the language most suited to the process to be performed. High-level (structured text) languages that allow structuring, such as C, are supported.

2. Easy to reuse well-proven programs

Efficiency when writing programs has been greatly increased by being able to split programming up for each function and process using structured programming.

3. Keep know-how from getting out

By "black boxing" a part of a program, you can prevent know-how from leaking out and improve the program's maintainability.

4. Conversion function for previously written programs provided to allow use of program assets.

5. Uploading of source programs from PLC possible.

Maintainability increased by being able to load programs and comments from the PLC.

* This only applies to FP-X, FPΣ and FP2 (with comment memory) and to FP2SH and FP10SH (with card board).

6. Programming for all models in the FP series possible.

Any model can be used.

■ Programming in the most suitable language

● Programming in the language most suited to the process

Easy-to-understand, efficient programs can be created, for example, by using a ladder program for machine control or ST for communications control.

● Programming in the language you are good at

Programming time can be greatly reduced by the easy ability to split and then integrate programming for each function and process.

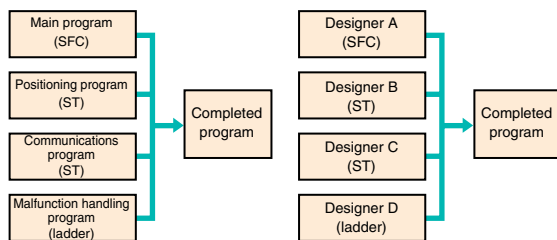

■ "Black boxing" of programs

● Multiple passwords for protection of each block

The security level (8 levels) can be input for each block in a program. Only users of a set security level or higher can make changes.

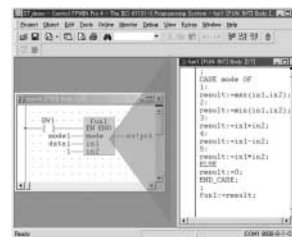
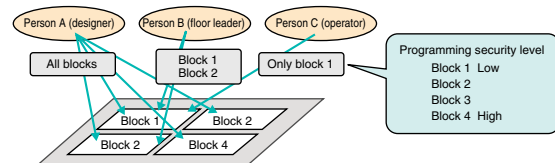

■ Reuse of programs is easy.

● Register time-proven programs by block in the library.

● By using variable identifiers (names), there is no need to be concerned with addresses for each machine when reusing programs.

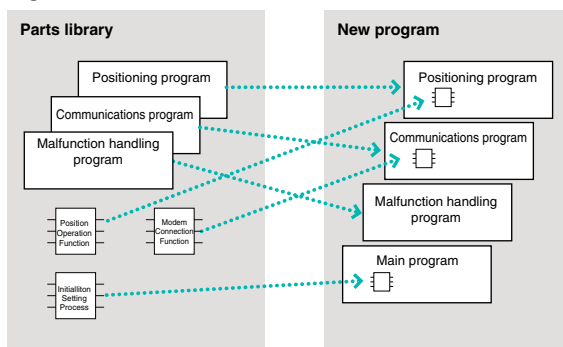

■ Operational Environment

OS	Windows95 (OSR2 or higher)/98/Me/NT (Ver. 4.0 or later)/2000/XP
Hard disk capacity	At least 100 MB
CPU	Pentium 100 MHz or higher
Onboard memory	At least 64 MB (depends on OS)
Screen resolution	At least 1024 × 768
Display colors	High Color (16-bit) or higher
Applicable PLC	FP-X/FP-e/FP0/FPΣ/FP1/FP-M/FP2/FP2SH/FP3/FP10SH
Compatible FP-X version	Relay output type: Ver.5.1 and after Transistor output type: Ver.5.3 and after (Available soon)

Part Number List

FP-X Control Unit

	Product name	Power supply	Specifications	Part number
Relay output	FP-X C14R Control unit	100 to 240V AC	8-point input of 24 V DC, 6-point output of 2 A relay Program capacity 16 ksteps, 2-point potentiometer	AFPX-C14R
	FP-X C30R Control unit	100 to 240V AC	16-point input of 24 V DC, 14-point output of 2 A relay Program capacity 32 ksteps, 2-point potentiometer, USB port	AFPX-C30R
	FP-X C60R Control unit	100 to 240V AC	32-point input of 24 V DC, 28-point output of 2 A relay Program capacity 32 ksteps, 4-point potentiometer, USB port	AFPX-C60R
Transistor output	FP-X C14TD Control unit	24V DC	8-point of 24 V DC, 6-point output of 0.5 A transistor (NPN) Program capacity 16 ksteps, 2-point potentiometer	AFPX-C14TD
	FP-X C14T Control unit	100 to 240V AC	8-point of 24 V DC, 6-point output of 0.5 A transistor (NPN) Program capacity 16 ksteps, 2-point potentiometer	AFPX-C14T
	FP-X C14PD Control unit	24V DC	8-point of 24 V DC, 6-point output of 0.5 A transistor (PNP) Program capacity 16 ksteps, 2-point potentiometer	AFPX-C14PD
	FP-X C14P Control unit	100 to 240V AC	8-point of 24 V DC, 6-point output of 0.5 A transistor (PNP) Program capacity 16 ksteps, 2-point potentiometer	AFPX-C14P
	FP-X C30TD Control unit	24V DC	16-point of 24 V DC, 14-point output of 0.5 A transistor (NPN) Program capacity 32 ksteps, 2-point potentiometer, USB port	AFPX-C30TD
	FP-X C30T Control unit	100 to 240V AC	16-point of 24 V DC, 14-point output of 0.5 A transistor (NPN) Program capacity 32 ksteps, 4-point potentiometer, USB port	AFPX-C30T
	FP-X C30PD Control unit	24V DC	16-point of 24 V DC, 14-point output of 0.5 A transistor (PNP) Program capacity 32 ksteps, 2-point potentiometer, USB port	AFPX-C30PD
	FP-X C30P Control unit	100 to 240V AC	16-point of 24 V DC, 14-point output of 0.5 A transistor (PNP) Program capacity 32 ksteps, 2-point potentiometer, USB port	AFPX-C30P
	FP-X C60TD Control unit	24V DC	32-point of 24 V DC, 28-point output of 0.5 A transistor (NPN) Program capacity 32 ksteps, 4-point potentiometer, USB port	AFPX-C60TD
	FP-X C60T Control unit	100 to 240V AC	32-point of 24 V DC, 28-point output of 0.5 A transistor (NPN) Program capacity 32 ksteps, 4-point potentiometer, USB port	AFPX-C60T
	FP-X C60PD Control unit	24V DC	32-point of 24 V DC, 28-point output of 0.5 A transistor (PNP) Program capacity 32 ksteps, 4-point potentiometer, USB port	AFPX-C60PD
	FP-X C60P Control unit	100 to 240V AC	32-point of 24 V DC, 28-point output of 0.5 A transistor (PNP) Program capacity 32 ksteps, 4-point potentiometer, USB port	AFPX-C60P

FP-X Expansion Unit

	Product name	Power supply	Specifications	Part number
Relay output	FP-X E16R Expansion I/O unit	—	8-point input of 24 V DC, 8-point relay output of 2 A Remarks; Two or more E16R can't be connected serially because it can't supply the power to other units. With an 8cm extension cable	AFPX-E16R
	FP-X E30R Expansion I/O unit	100 to 240V AC	16-point input of 24 V DC, 14-point relay output of 2 A Remarks; Possible to connect up to 8 units including E16R, EFP0. With an 8cm extension cable	AFPX-E30R
	FP-X E16T Expansion I/O unit	—	8-point input of 24 V DC, 8-point transistor (NPN) output of 0.5 A Remarks; Two or more E16T cannot be connected serially because it cannot supply the power to other units. With an 8cm extension cable	AFPX-E16T
Transistor output	FP-X E16P Expansion I/O unit	—	8-point input of 24 V DC, 8-point transistor (PNP) output of 0.5 A Remarks; Two or more E16P cannot be connected serially because it cannot supply the power to other units. With an 8cm extension cable	AFPX-E16P
	FP-X E30TD Expansion I/O unit	24V DC	16-point input of 24 V DC, 14-point transistor (NPN) output of 0.5 A Remarks; Possible to connect up to 8 units including E16, EFP0. With an 8cm extension cable	AFPX-E30TD
	FP-X E30T Expansion I/O unit	100 to 240V AC	16-point input of 24 V DC, 14-point transistor (NPN) output of 0.5 A Remarks; Possible to connect up to 8 units including E16, EFP0. With an 8cm extension cable	AFPX-E30T
	FP-X E30PD Expansion I/O unit	24V DC	16-point input of 24 V DC, 14-point transistor (PNP) output of 0.5 A Remarks; Possible to connect up to 8 units including E16, EFP0. With an 8cm extension cable	AFPX-E30PD
	FP-X E30P Expansion I/O unit	100 to 240V AC	16-point input of 24 V DC, 14-point transistor (PNP) output of 0.5 A Remarks; Possible to connect up to 8 units including E16, EFP0. With an 8cm extension cable	AFPX-E30P
	Expansion FP0 Adapter	24V DC	Up to 3 FP0 expansion units can be connected via an adapter. With an 8cm extension cable and power cable	AFPX-EFP0

FP-X Add-on Cassette

Product name	Specifications	Part number
FP-X COM1 Communication cassette	RS232C 1 ch. RS, CS control signal equipped (non-insulated)	AFPX-COM1
FP-X COM2 Communication cassette	RS232C 2 ch. (non-insulated)	AFPX-COM2
FP-X COM3 Communication cassette	RS485/422 selectable 1ch (insulated)	AFPX-COM3
FP-X COM4 Communication cassette	RS485 1 ch. (insulated) + RS232C 1 ch. (non-insulated)	AFPX-COM4
FP-X COM5 Communication cassette	Ethernet 1 ch.(10BASE-T, 100BASE-TX) + RS232C 1 ch. (non-insulated)	AFPX-COM5
FP-X Input cassette	8 point input of 24 V DC	AFPX-IN8
FP-X Output cassette	8 point output of NPN 0.3 A	AFPX-TR8
	6 point output of PNP 0.5 A	AFPX-TR6P
FP-X Analog input cassette	2 point 12-bit non-insulated 0 to 10 V DC/0 to 20 mA	AFPX-AD2
FP-X Pulse I/O cassette (for relay output type control unit only)	High-speed counter: single-phase 2 ch., each 80 kHz or two-phase 1 ch., 30 kHz. Pulse output: one axis 100 kHz/ch. (Use restriction is applied for a two-unit installation)	AFPX-PLS
FP-X Master memory with a real-time clock	Master memory: Capable of storing all program steps and comments simultaneously. Storage of FPWIN Pro source files. Real-time clock: Year, month, day, hour, minute, second, day of week (optional battery required)	AFPX-MRTC

FP-X Options and Service Parts

Product name	Specifications	Part number
FP-X Backup battery	Battery for backing up the operation memory and real-time clock	AFPX-BATT
FP-X Expansion cable (8 cm)	Expansion unit connection cable, 8 cm	AFPX-EC08
FP-X Expansion cable (30 cm)	Expansion unit connection cable, 30 cm	AFPX-EC30
FP-X Expansion cable (80 cm)	Expansion unit connection cable, 80 cm	AFPX-EC80
FP-X Terminal block	Terminal block for C30, C60 and E30, 21 pins, cover with no marking, five units included	AFPX-TAN1

Part Number List

FP0 Expansion Units

Product name	Specifications						Product number	Part number
	Number of I/O points	Power supply voltage	Input	Output	Connection type			
FP0 E8 Expansion Unit	8	Input: 8	–	24 V DC Sink/Source (±common)	–	MIL connector	FP0-E8X	AFP03003
	8	Input: 4 Output: 4	24 V DC	24 V DC Sink/Source (±common)	Relay output: 2 A	Terminal block	FP0-E8RS	AFP03023
	8	Output: 8	24 V DC	–	Relay output: 2 A	Molex connector	FP0-E8RM	AFP03013
	8	Output: 8	–	–	Relay output: 2 A	Terminal block	FP0-E8YRS	AFP03020
FP0 E16 Expansion Unit	16	Input: 16	–	24 V DC Sink/Source (±common)	–	MIL connector	FP0-E16X	AFP03303
	16	Input: 8 Output: 8	24 V DC	24 V DC Sink/Source (±common)	Relay output: 2 A	Terminal block	FP0-E16RS	AFP03323
	16	Input: 8 Output: 8	–	24 V DC Sink/Source (±common)	Relay output: 2 A	Molex connector	FP0-E16RM	AFP03313
	16	Output: 8	–	–	Transistor output: NPN 0.1 A	MIL connector	FP0-E16T	AFP03343
FP0 E16 Expansion Unit	16	Output: 16	–	–	Transistor output: NPN 0.1 A	MIL connector	FP0-E16YT	AFP03340
FP0 E32 Expansion Unit	32	Input: 16 Output: 16	–	24 V DC Sink/Source (±common)	Transistor output: NPN 0.1 A	MIL connector	FP0-E32T	AFP03543

- Notes: 1) The relay output type expansion units come with a power cable (part number AFP0581). (The transistor output type needs no power cable.)
 2) The terminal block type relay output units have 2 terminal blocks (9 pins) made by Phoenix. Use a 2.5 mm wide screwdriver.
 Preferably use the specific terminal block screwdriver (part number AFP0806, Phoenix type code SZS 0.4 × 2.5 mm) or equivalent.
 3) The connector-type relay output units have 2 connectors made by Nihon Molex (Molex type code 51067-0900, 9 pins).
 Use the specific Molex connector press-fit tool (part number AFP0805, Nihon Molex type code 57189-5000) or equivalent.
 4) The transistor output units have a press-fit socket for wire-pressed terminal cable and contacts. Use the press-fit tool (part number AXYS2000) for wire-pressed terminal cable.

FP0 Intelligent Units

Product name	Specifications	Product number	Part number
FP0 Thermocouple unit	K, J, T, R thermocouple, Resolution: 0.1 °C	FP0-TC4	AFP0420
	K, J, T, R thermocouple, Resolution: 0.1 °C	FP0-TC8	AFP0421
FP0 Analog I/O unit	<Input specifications> Number of channels: 2 channels Input range: 0 to 5 V, -10 to +10 V (Resolution: 1/4000) 0 to 20 mA (Resolution: 1/4000)	FP0-A21	AFP0480
	<Output specifications> Number of channels: 1 channel Output range: -10 to +10 V (Resolution: 1/4000) 0 to 20 mA (Resolution: 1/4000)		
FP0 A/D Converter Unit	<Input specifications> Number of channels: 8 channels Input range: 0 to 5, -10 to +10 V, -100 to 100 mV (Resolution: 1/4000) 0 to 20 mA (Resolution: 1/4000)	FP0-A80	AFP0401
FP0 D/A Converter Unit	<Output specifications> Number of channels: 4 channels Output range: -10 to +10 V (Resolution: 1/4000) 4 to 20 mA (Resolution: 1/4000)	FP0-A04V	AFP04121
		FP0-A04I	AFP04123

FP0 Link Units

Product name	Specifications	Power supply voltage	Product number	Part number
FP0 CC-Link Slave unit	This unit is for making the FP0 function as a slave station of the CC-Link. Only one unit can be connected to the furthest right edge of the FP0 expansion bus. Note: Accuracy will change if an FP0 thermocouple unit is used at the same time. For details, please refer to the FP0 catalog or to the CC-Link Unit manual.	24 V DC	FP0-CCLS	AFP07943
FP0 I/O Link unit	This is a link unit designed to make the FP0 function as a station to MEWNET-F (remote I/O system).	24 V DC	FP0-IOL	AFP0732

Control FPWIN GR for Windows

Product name	Type	Part number	Applicable PLC										
			FP-X	FPΣ	FP0 FP-e	FP0 10k	FP1*	FP2	FP2SH	FP-M*	FP3* FP10SH		
FPWIN GR for Windows	English: Full type	CD-ROM for Windows	AFPS10520	A	A	A	A	A	A	A	A	A	A
	English: Small type	CD-ROM for Windows	AFPS11520	A	A	A	A	A	N/A	N/A	A	N/A	N/A
	English: Ver. up type	CD-ROM for Windows	AFPS10520R	A	A	A	A	A	A	A	A	A	A
	Chinese	CD-ROM for Windows	AFPS10820										
	Chinese: Ver. up type	CD-ROM for Windows	AFPS10820R										
	Korean	CD-ROM for Windows	AFPS10920										

*The production of FP1, FP-M, FP3/FP10SH has been discontinued.

A: Available, N/A: Not available

Control FPWIN Pro (IEC61131-3 compliant Windows version software)

Product name	Type	Part number	Applicable PLC										
			FP-X	FPΣ	FP0 FP-e	FP0 10k	FP1*	FP2	FP2SH	FP-M*	FP3* FP10SH		
FPWIN Pro for Windows	English: Full type	CD-ROM for Windows	AFPS50550	A	A	A	A	A	A	A	A	A	A
	English: Small type	CD-ROM for Windows	AFPS51550	A	A	A	A	A	N/A	N/A	A	N/A	N/A

*The production of FP1, FP-M, FP3/FP10SH has been discontinued.

A: Available, N/A: Not available

Programmable Display GT series

Product name	Description			Part number	
GT01: Main Unit	STN monochrome LCD	5 V DC	RS232C type	Black	AIGT0030B1
				Ash gry	AIGT0030H1
			RS422/RS485 type	Black	AIGT0032B1
		24 V DC	RS232C type	Ash gry	AIGT0032H1
				Black	AIGT0030B
			RS422/RS485 type	Ash gry	AIGT0030H
GT11: Main Unit	STN monochrome LCD	24 V DC	RS232C type	Black	AIGT0032B
				Ash gry	AIGT0032H
			RS422/RS485 type	Black	AIGT2030B
		24 V DC	RS232C type	Ash gry	AIGT2030H
				Black	AIGT2032B
			RS422/RS485 type	Ash gry	AIGT2032H
GT21C: Main Unit	STN color LCD	24 V DC	RS232C type	Black	AIGT2230B
				Silver	AIGT2230H
			RS422/RS485 type	Black	AIGT2232B
		24 V DC	RS232C type	Black	AIGT2230B
				Silver	AIGT2230H
			RS422/RS485 type	Black	AIGT2232B
			Silver	AIGT2232H	

Related Products List

FP Memory Loader

Product name	Part number
Data non-hold type	AFP8670
Data hold type	AFP8671

PCWAY Ver. 2.7 (Operation Data Managing Software)

Product name	Part number
PCWAY IBM printer port version	AFW10011
PCWAY USB port version	AFW10031
PCWAY Version upgrade	AFW10401

* Charged version upgrade for Ver. 2.0 to 2.6.

Control CommX Ver. 1.3 (OCX for Communication)

Product name	Part number
Control CommX IBM printer port	AFW20011
Control CommX USB port	AFW20031

FP Web-Server Unit

Product name	Part number
FP Web-Server unit	AFP0610
FP Web Configurator Tool	AFPS30510

Key Unit

Economical type is available for secondary key.
The key unit is available for PCWAY and Control CommX.

Product name	Part number
Key unit IBM printer port version	AFW1031*
Key unit USB port version	AFW1033

*The discontinuation of AFW1031 production is scheduled for August 2007.

Specifications

1. General Specifications

Item	Description
Rated voltage	100 to 240 V AC (AC power), 24 V DC (DC power)
Operating voltage range	85 to 264 V AC (AC power), 20.4 to 28.8 V DC (DC power)
Rush current	40 A or less (C14), 45 A or less (C30, C60) at 25°C (AC power) 12 A or less at 25°C (DC power)
Allowed momentary power off time	10 ms or more
Ambient temperature	0 to +55°C
Storage temperature	-40 to +70°C
Ambient humidity	10 to 95% RH (at 25 °C, non-condensing)
Storage humidity	10 to 95% RH (at 25 °C, non-condensing)
Breakdown voltage	Combined input/output terminals - Combined power and ground terminals, 2300 V AC 1 minute (AC power), 500 V AC ^{*1} 1 minute (DC power)
	Input terminals - Relay output terminals, 2300 V AC ^{*1} 1 minute
	Input terminals - Transistor output terminals, 500 V AC ^{*1} 1 minute
Insulation resistance	Power terminals - Ground terminals, 1500 V AC ^{*1} 1 minute (AC power), 500 V AC ^{*1} 1 minute (DC power)
	Combined input/output terminals - Combined power and ground terminals, 100 MΩ or higher (500 V DC using an insulation resistance meter)
	Input terminals - Output terminals, 100 MΩ or higher (500 V DC using an insulation resistance meter)
Vibration resistance	Power terminals - Ground terminals, 100 MΩ or higher (500 V DC using an insulation resistance meter)
Shock resistance	5 to 9 Hz, single amplitude 3.5 mm/9 to 150 Hz, constant acceleration 9.8 m/s ² , 1 sweep/min, 10 sweeps in each XYZ direction 147 m/s ²
Noise immunity	1500 V [P-P] pulse width 50 ns, 1 μs (AC power), 500 V [P-P] pulse width 50 ns, 1 μs (DC power) (per noise simulator method) (power terminals)
Operating condition	No corrosive gas and no excessive dust
EC Directive Compliance Standard	Conforming to EN61131-2
Level of contamination	2
Over-voltage category	II

*1 Cutoff current 5 mA

2. Power Consumption, Weight

Product name	Part number	Current consumption	Weight
Control unit	AFPX-C14○○	26 W or less ^{*2}	Approx. 280 g or less
	AFPX-C30○○	52 W or less ^{*2}	Approx. 490 g or less
	AFPX-C60○○	64 W or less ^{*2}	Approx. 780 g or less
Expansion I/O unit	AFPX-E16○○	8 W or less ^{*2}	Approx. 195 g or less
	AFPX-E30○○	42 W or less ^{*2}	Approx. 430 g or less
Expansion FP0 adapter	AFPX-EFP0	0.24 W or less ^{*3}	Approx. 65 g
FP-X communication cassette	AFPX-COM1	2 W or less ^{*2}	Approx. 20 g
	AFPX-COM2	2 W or less ^{*2}	Approx. 20 g
	AFPX-COM3	2 W or less ^{*2}	Approx. 20 g
	AFPX-COM4	2 W or less ^{*2}	Approx. 20 g
	AFPX-COM5	2 W or less ^{*2}	Approx. 20 g
FP-X analog input cassette	AFPX-AD2	2 W or less ^{*2}	Approx. 25 g
FP-X input cassette	AFPX-IN8	1 W or less ^{*2}	Approx. 25 g
FP-X output cassette	AFPX-TR8	1 W or less ^{*2}	Approx. 25 g
	AFPX-TR6P	1 W or less ^{*2}	Approx. 25 g
FP-X pulse I/O cassette	AFPX-PLS	2 W or less ^{*2}	Approx. 25 g
FP-X master memory cassette	AFPX-MRTC	2 W or less ^{*2}	Approx. 20 g

*2 Power consumption by the AC power supply connected to the control unit *3 Power consumption by the DC power supply connected to the expansion FP0 adapter

*4 Please refer to FP0 users manual for FP0 expansion units.

Please refer to the user manual and specifications for further details.

Specifications

3. Controls Specifications

Item	Specifications	
Program method	Relay symbol method	
Control method	Cyclic operation method	
Program memory	Flash ROM built-in (no battery backup required)	
Program capacity	16 ksteps (C14), 32 ksteps (C30, C60)	
Operation processing speed	Basic instruction 0.32 μs/step	
Basic instructions	111	
Applied instructions	216	
External inputs (X)	1760 points *4	
External outputs (Y)	1760 points *4	
Internal relay (R)	4096 points	
Special internal relay (R)	192 points	
Link relay (L)	2048 points	
Timer/counter (T/C)	Total 1024 points: timer capable of counting (1 ms, 10 ms, 100 ms, 1 s) x 32767 Counter capable of counting 1 to 32767	
Data register (DT)	12285 words (C14), 32765 words (C3R, C60)	
Link data register (LD)	256 words	
Special data register (DT)	374 words	
Index register (I0 to ID)	14 words	
Master control relay (MCR)	256 points	
Number of labels (LOOP)	256 labels	
Number of differentiations	Up to program capacity	
Number of stepladders	1000 stages	
Number of subroutines	500 subroutines	
Number of interruption programs	Relay output type: 15 programs (14 external, 1 constant) Transistor output type: 9 programs (8 external, 1 constant)	
High-speed counter *5	Built-in (Transistor output): single-phase 8 ch (50 kHz x 4 ch + 10 kHz x 4 ch) Built-in (Relay output): single-phase 8 ch (10 kHz x 8 ch) Pulse I/O cassette (AFPX-PLS) for relay output type: single-phase 2 ch (80 kHz x 2 ch)	
Pulse output *6	Built-in (Transistor output): 100 kHz x 2 ch + 20 kHz x 2 ch Pulse I/O cassette (AFPX-PLS) for relay output type: One unit (one axis) 100 kHz, or two units (two axes) 80 kHz	
Pulse catch input / interrupt input	Relay output type: Total 14 points (including the high-speed counter) Transistor output type: Total 8 points (including the high-speed counter)	
Periodical interrupt	0.5 ms to 30 s	
Potentiometer	2 points (0 to 1000) (C14, C30) 4 points (0 to 1000) (C60)	
Constant scan	Possible	
Real-time clock	Equipped (usable only when AFPX-MRTC is installed) *7	
Flash ROM backup *9	Backup by F12, P13 commands	Data register (32765 words)
	Auto-backup at power failure	Counter 16 points (1008 to 1023), Internal relay 128 points (R2470 to R255F), Data register 55 words
Battery backup	The memory allocated in the storage area by the system register (only when a battery is installed) *8	
Battery life (when no power is supplied)	Before installing AFPX-MRTC C14: 1230 days (actual operation 10 years at 25°C) C30, C60: 990 days (actual operation 10 years at 25°C) After installing AFPX-MRTC C14: 780 days (actual operation 10 years at 25°C) C30, C60: 680 days (actual operation 10 years at 25°C) (More than two batteries can be installed in C30 and C60. In this case, the battery life is extended several times)	
Password	Capable (4 or 8 characters selectable)	
Self-diagnosis function	Watch dog timer, program syntax check	
Comment storage	Capable (328 KB) (backup battery not required)	
PLC link function	Max 16 units, link relay 1024 points, link register 128 words (No data transfer or remote programming)	
Rewriting in RUN mode	Capable	

*4 The actual usable number of points is restricted by the hardware.

*5 Specification at the rated input voltage of 24 V DC, 25°C. Frequency may be lower due to the voltage and temperature.

*6 Max frequency may vary by the method of operation. Please refer to the manual for details.

*7 Calendar accuracy at 0°C: 119 sec/month or less, 25°C: 51 sec/month or less, 55°C: 148 sec/month or less (Real-time clock requires a battery.)

*8 When data is stored in the storage area while the battery is not installed, the data is not cleared and the data value may be indefinite.

The same condition occurs when the battery is exhausted.

*9 The number of possible rewrites is 10,000 or less.

Specifications

4. Input Specifications (Control unit, expansion unit)

Item		Description	
		Relay output	Transistor output
Insulation method		Photo-coupler	
Rated input voltage		24 V DC	
Operating voltage range		21.6 to 26.4 V DC	
Rated input current		Approx. 4.7 mA (Control unit X0 to X7)	Approx. 8 mA (Control unit X0 to X3)
		Approx. 4.3 mA (Control unit X8 and after, expansion unit)	Approx. 4.7 mA (Control unit X4 to X7)
Input points per common		8 points/common (C14, E16) 16 points/common (C30, C60)	
		(Input power polarity either positive or negative)	
Min. ON voltage/ON current		19.2 V/3 mA	19.2 V/6 mA (Control unit X0 to X3) 19.2 V/3 mA (Control unit X4 and after, expansion unit)
Max. OFF voltage/OFF current		2.4 V/1 mA	2.4 V/1.3 mA (Control unit X0 to X3) 2.4 V/1 mA (Control unit X4 and after, expansion unit)
Input impedance		Approx. 5.1 k Ω (Control unit X0 to X7)	Approx. 3 k Ω (Control unit X0 to X3)
		Approx. 5.6 k Ω (Control unit X8 and after, expansion unit)	Approx. 5.1 k Ω (Control unit X4 to X7) Approx. 5.6 k Ω (Control unit X8 and after, expansion unit)
Response time	OFF \rightarrow ON	Control unit X0 to X7 0.6 ms or less: Normal input 50 ms or less: High-speed counter, pulse catch, interruption input setting*1 Control unit X8 and after, expansion unit 0.6 ms or less	Control unit X0 to X3 135 μ s or less: Nominal input 5 μ s or less: High-speed counter, pulse catch, interruption input setting*1 Control unit X4 to X7 135 μ s or less: Nominal input 50 μ s or less: High-speed counter, pulse catch, interruption input setting*1 Control unit X8 and after, expansion unit 0.6 ms or less
	ON \rightarrow OFF	Same as above	
Operating indicator		LED display	

*1 Specification at the rated input voltage of 24 V DC, 25°C.

5. Relay Output Specifications (Control units, Expansion units)

Item		Description
Output type		1a contact
Rated control capacity (Resistive load)		2 A 250 V AC, 2 A 30 V DC (8 A or less/common)
Output points per common		4 points/common
Response time	OFF \rightarrow ON	Approx. 10 ms
	ON \rightarrow OFF	Approx. 8 ms
Life time	Mechanical	20 million operations or more (Operation frequency 180 times/min)
	Electrical	100,000 operations or more (Operation frequency 20 times/min at the rated control capacity)
Surge absorber		None
Operating indicator		LED display

6. Transistor Output Specifications

Item		Description
Insulation method		Photocoupler
Output type		Open collector
Rated load voltage		NPN type: 5 to 24 V DC, PNP type: 24 V DC
Load voltage allowable range		NPN type: 4.75 to 26.4 V DC, PNP type: 21.6 to 26.4 V DC
Max. load current		0.5 A
Max. inrush current		1.5 A
Output points per common		8 points/common (C14, E16) 8 points/common, 6 points/common (C30, C60, E30)
OFF state leakage current		1 μ A or less
ON state voltage drop		0.3 V DC or less
Response time	OFF \rightarrow ON	1 ms or less*2
	ON \rightarrow OFF	1 ms or less*2
Voltage range for external power supply		21.6 to 26.4 V DC
Surge absorber		Zener diode
Operating indicator		LED display

*2 Please refer to the user manual for Y0 to Y7 of the transistor output type.

FP-X Control Unit Dimensions (Unit: mm)

●AFPX-C14 ** (The same dimensions apply to the expansion I/O unit AFPX-E16**)

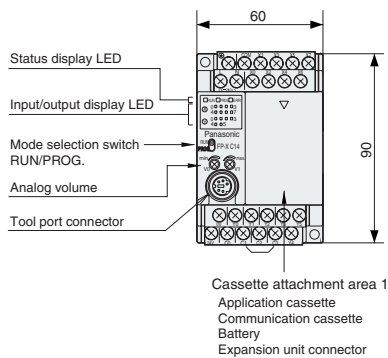

Dimensions when expansion cassettes (function and communication) are installed

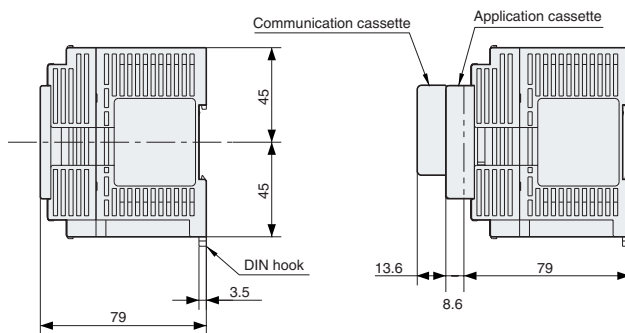

●AFPX-C30 ** (The same dimensions apply to the expansion I/O unit AFPX-E30**)

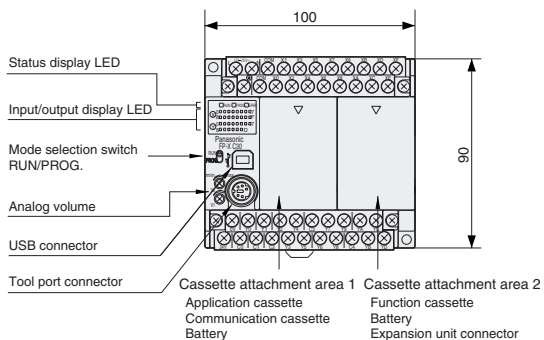

Mounting dimension diagram

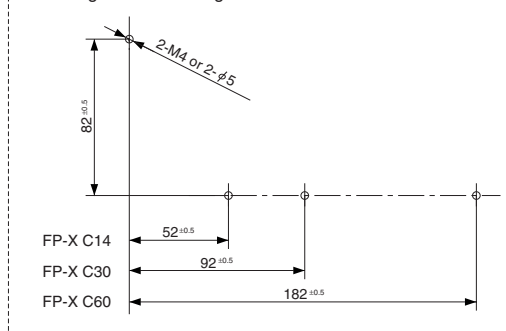

●AFPX-C60 **

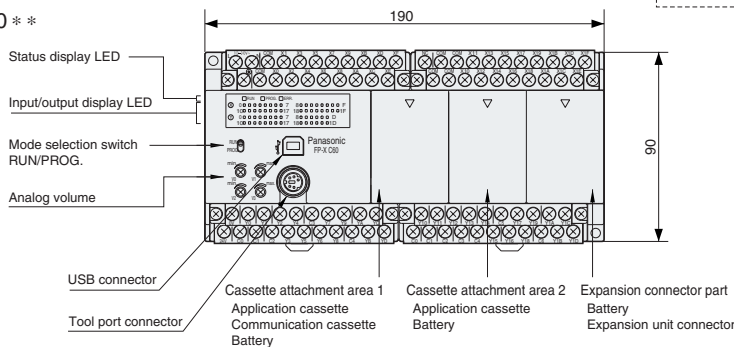

FP-X Expansion FP0 Adapter Dimensions (Unit: mm)

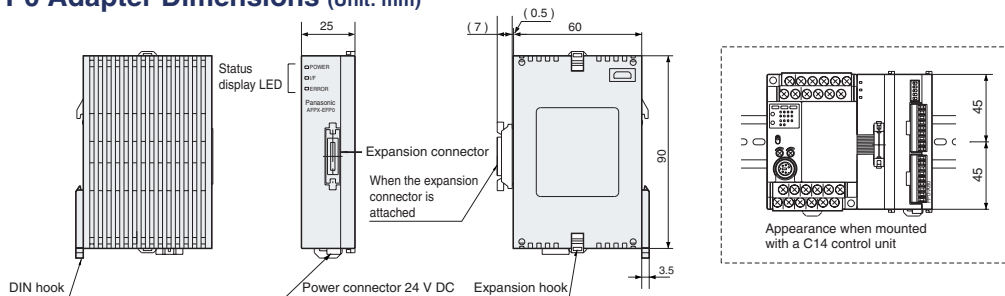

These materials are printed on ECF pulp.
These materials are printed with earth-friendly vegetable-based (soybean oil) ink.



Please contact

Matsushita Electric Works, Ltd.

Automation Controls Business Unit

■ Head Office: 1048, Kadoma, Kadoma-shi, Osaka 571-8686, Japan

Panasonic®

All Rights Reserved © 2006 COPYRIGHT Matsushita Electric Works, Ltd.