

Boric Acid Fuses

Medium Voltage



Catalog Symbol: BBU

Medium Voltage Expulsion Fuse

Fuse Class: E (Standard), SE (Slow E) & K (Fast)

Voltage Rating: 17kV, 27kV & 38kV

Interrupting Ratings:

17kV - 14kA

27kV - 12.5kA

38kV - 10kA

Boric Acid, expulsion style fuses meet:

- ANSI C37.40 – Service Conditions and Definitions
- ANSI C37.41 – Power Fuse Design and Testing
- ANSI C37.42 – Distribution Fuse Ratings and Specifications
- ANSI C37.46 – Power Fuse Ratings and Specifications
- ANSI C37.48 – Power Fuse Application, Operations and Maintenance

General

- The BBU power fuse is a Boric Acid, expulsion style fuse unit.
- Provides a low initial cost alternative to refillable fuses in indoor applications.
- Utilizes calibrated silver elements, boric acid for its interrupting media, and a spring & rod mechanism.
- The housing is a fiberglass reinforced resin tube with plated copper contacts.
- Available in 3 maximum voltage classes:
17kV, 27kV & 38kV
- Available in 3 speed variations:
E (Standard) SE (Slow E) & K (Fast)
- Visual Indicating with use of end fittings.
- End Fittings:
 - End fittings are required to complete the electrical connection between the fuse unit and the live parts and mounting.
 - The indoor fittings accept a Muffler attachment to limit noise and contamination to indoor equipment. The open fuse indicator located on the top end fitting provides visual indication on a faulted fuse unit.

Applications

The BBU Boric Acid fuse provides effective protection for circuits and equipment which operate on voltage systems up to 34,500V. Typical usage is on industrial distribution systems for:

- Power Transformers
- Feeder Circuits
- Distribution Transformers
- Metal Enclosed Switchgear
- Pad Mounted Switches

Boric Acid Fuses

Medium Voltage

BBU

Illustration & Diimensional Data

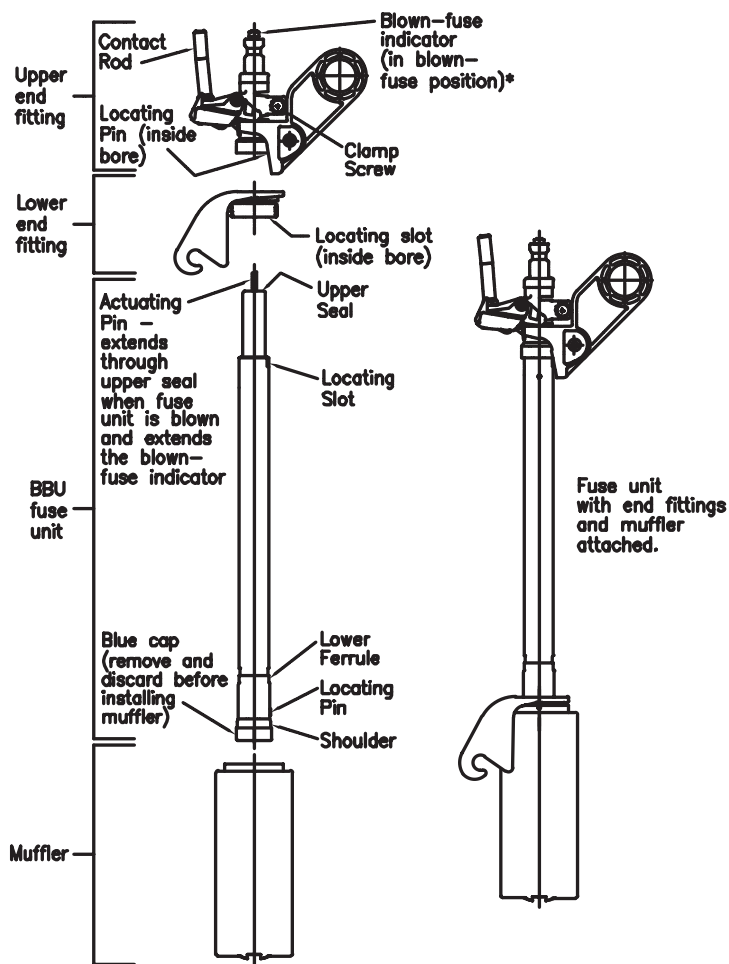

kV Max.	Fuse Unit Fittings		
	A	B	C
17	19.08	27.19	28.82
27	22.58	30.69	32.32
38	28.76	36.87	38.50

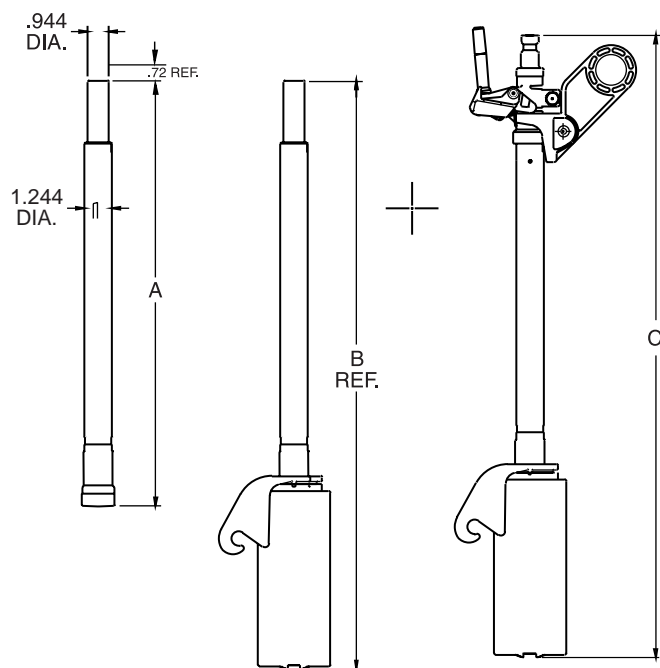

Boric Acid Fuses

Medium Voltage

BBU Boric Acid Fuses for Use Indoors

Amps	Fuse Type	Voltage (kV)	Catalog Number	Max. Int. kA Sym	Indoor		
					End Fittings	Catalog Number	Ampere Rating
3	K	17	BBU17-3K	14		BBU-EFID	3K to 200K
6	K	17	BBU17-6K				
8	K	17	BBU17-8K				
10	K	17	BBU17-10K				
12	K	17	BBU17-12K				
15	K	17	BBU17-15K				
20	K	17	BBU17-20K				
25	K	17	BBU17-25K				
30	K	17	BBU17-30K				
40	K	17	BBU17-40K				
50	K	17	BBU17-50K				
65	K	17	BBU17-65K				
80	K	17	BBU17-80K				
100	K	17	BBU17-100K				
140	K	17	BBU17-140K				
200	K	17	BBU17-200K				
5	E	17	BBU17-5E	14		BBU-EFID	5E to 200E
7	E	17	BBU17-7E				
10	E	17	BBU17-10E				
13	E	17	BBU17-13E				
15	E	17	BBU17-15E				
20	E	17	BBU17-20E				
25	E	17	BBU17-25E				
30	E	17	BBU17-30E				
40	E	17	BBU17-40E				
50	E	17	BBU17-50E				
65	E	17	BBU17-65E				
80	E	17	BBU17-80E				
100	E	17	BBU17-100E				
125	E	17	BBU17-125E				
150	E	17	BBU17-150E				
175	E	17	BBU17-175E				
200	E	17	BBU17-200E				
15	SE	17	BBU17-15SE	14		BBU-EFID	15SE to 200SE
20	SE	17	BBU17-20SE				
25	SE	17	BBU17-25SE				
30	SE	17	BBU17-30SE				
40	SE	17	BBU17-40SE				
50	SE	17	BBU17-50SE				
65	SE	17	BBU17-65SE				
80	SE	17	BBU17-80SE				
100	SE	17	BBU17-100SE				
125	SE	17	BBU17-125SE				
150	SE	17	BBU17-150SE				
175	SE	17	BBU17-175SE				
200	SE	17	BBU17-200SE				
3	K	27	BBU27-3K				
6	K	27	BBU27-6K				
8	K	27	BBU27-8K				
10	K	27	BBU27-10K				
12	K	27	BBU27-12K				
15	K	27	BBU27-15K				
20	K	27	BBU27-20K				
25	K	27	BBU27-25K				
30	K	27	BBU27-30K				
40	K	27	BBU27-40K				
50	K	27	BBU27-50K				
65	K	27	BBU27-65K				
80	K	27	BBU27-80K				
100	K	27	BBU27-100K				
140	K	27	BBU27-140K				
200	K	27	BBU27-200K				
5	E	27	BBU27-5E	12.5		BBU-EFID	5E to 200E
7	E	27	BBU27-7E				
10	E	27	BBU27-10E				
13	E	27	BBU27-13E				
15	E	27	BBU27-15E				
20	E	27	BBU27-20E				
25	E	27	BBU27-25E				
30	E	27	BBU27-30E				
40	E	27	BBU27-40E				
50	E	27	BBU27-50E				
65	E	27	BBU27-65E				
80	E	27	BBU27-80E				
100	E	27	BBU27-100E				
140	E	27	BBU27-140E				
200	E	27	BBU27-200E				

Amps	Fuse Type	Voltage (kV)	Catalog Number	Max. Int. kA Sym	Indoor						
					End Fittings	Catalog Number	Ampere Rating				
50	E	27	BBU27-50E	12.5		BBU-EFID	5E to 200E				
65	E	27	BBU27-65E								
80	E	27	BBU27-80E								
100	E	27	BBU27-100E								
125	E	27	BBU27-125E								
150	E	27	BBU27-150E								
175	E	27	BBU27-175E								
200	E	27	BBU27-200E								
15	SE	27	BBU27-15SE					12.5		BBU-EFID	15SE to 200SE
20	SE	27	BBU27-20SE								
25	SE	27	BBU27-25SE								
30	SE	27	BBU27-30SE								
40	SE	27	BBU27-40SE								
50	SE	27	BBU27-50SE								
65	SE	27	BBU27-65SE								
80	SE	27	BBU27-80SE								
100	SE	27	BBU27-100SE								
125	SE	27	BBU27-125SE								
3	K	38	BBU38-3K	10		BBU-EFID	3K to 200K				
6	K	38	BBU38-6K								
8	K	38	BBU38-8K								
10	K	38	BBU38-10K								
12	K	38	BBU38-12K								
15	K	38	BBU38-15K								
20	K	38	BBU38-20K								
30	K	38	BBU38-30K								
40	K	38	BBU38-40K								
50	K	38	BBU38-50K								
65	K	38	BBU38-65K								
80	K	38	BBU38-80K								
100	K	38	BBU38-100K								
140	K	38	BBU38-140K								
200	K	38	BBU38-200K								
5	E	38	BBU38-5E	10		BBU-EFID	5E to 200E				
7	E	38	BBU38-7E								
10	E	38	BBU38-10E								
13	E	38	BBU38-13E								
15	E	38	BBU38-15E								
20	E	38	BBU38-20E								
25	E	38	BBU38-25E								
30	E	38	BBU38-30E								
40	E	38	BBU38-40E								
50	E	38	BBU38-50E								
65	E	38	BBU38-65E								
80	E	38	BBU38-80E								
100	E	38	BBU38-100E								
125	E	38	BBU38-125E								
150	E	38	BBU38-150E								
175	E	38	BBU38-175E								
200	E	38	BBU38-200E								
15	SE	38	BBU38-15SE	10		BBU-EFID	15SE to 200SE				
20	SE	38	BBU38-20SE								
25	SE	38	BBU38-25SE								
30	SE	38	BBU38-30SE								
40	SE	38	BBU38-40SE								
50	SE	38	BBU38-50SE								
65	SE	38	BBU38-65SE								
80	SE	38	BBU38-80SE								
100	SE	38	BBU38-100SE								
125	SE	38	BBU38-125SE								
150	SE	38	BBU38-150SE								
175	SE	38	BBU38-175SE								
200	SE	38	BBU38-200SE								

*Note: Muffler can be ordered separately. Order Catalog number BBU-MFLR.

Boric Acid Fuses

Medium Voltage

BBU

Time Current Characteristics

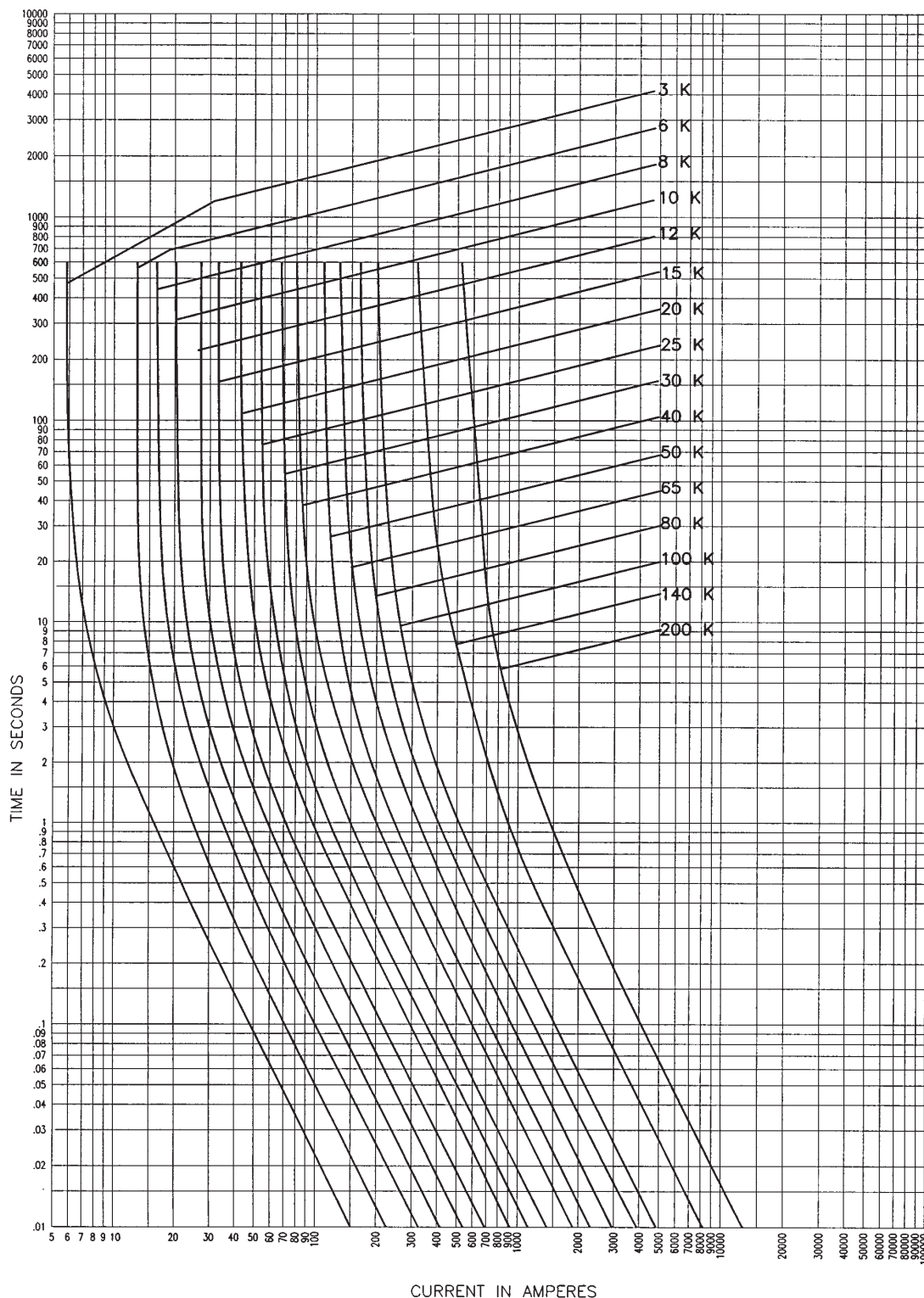

Type BBU Standard K Speed Fuses
 Minimum Melting Time-Current Characteristics - 17.1 to 38 kV
 Curves are based on tests starting with fuse unit at ambient temperature of 25 C and without initial load. Curves are plotted to minimum test points so all variations should be positive.

Boric Acid Fuses

Medium Voltage

BBU

Time Current Characteristics

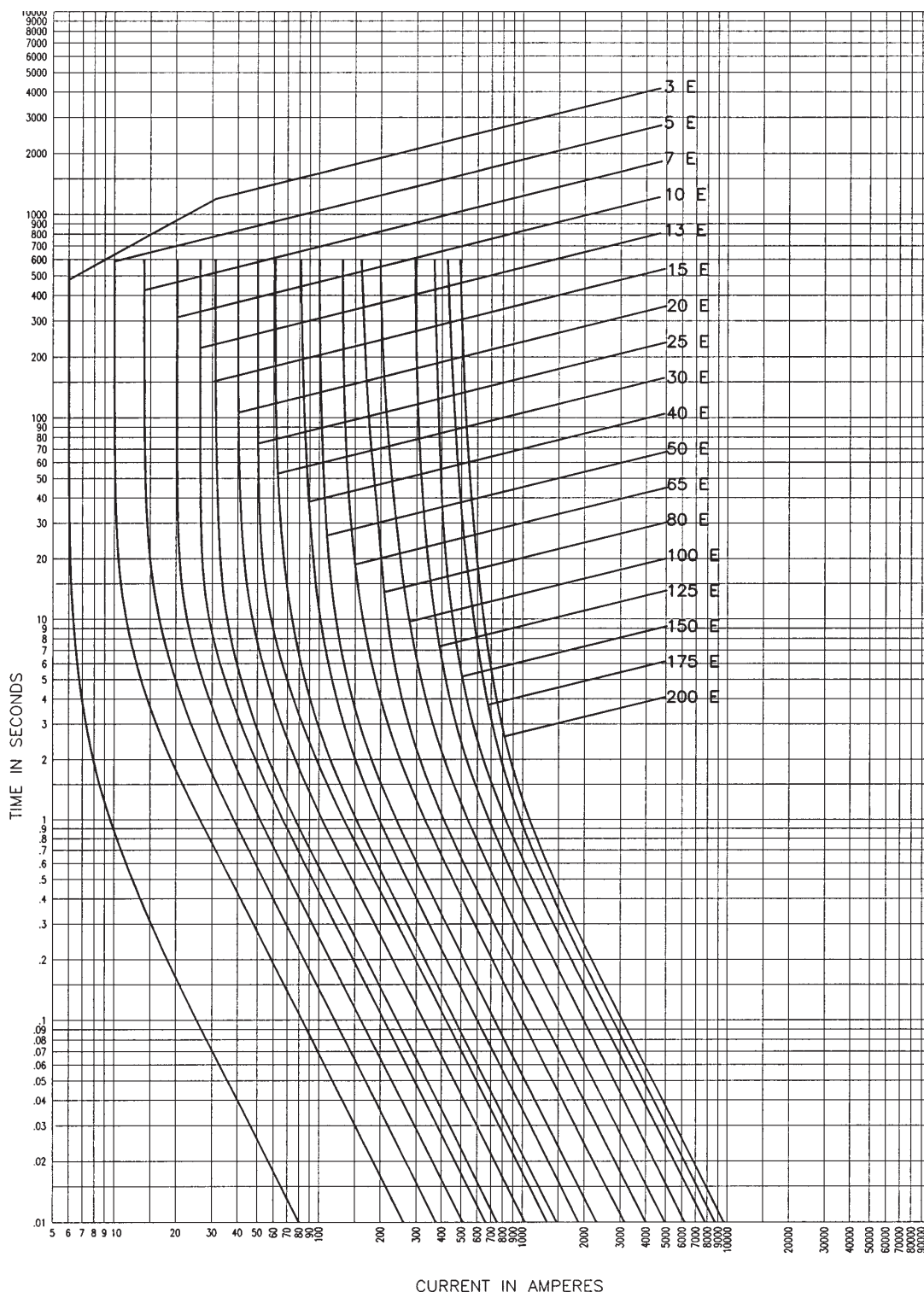

Type BBU Standard E Fuses
 Minimum Melting Time-Current Characteristics - 17.1 to 38 kV
 Curves are based on tests starting with fuse unit at ambient temperature of 25 C and without initial load. Curves are plotted to minimum test points so all variations should be positive.

Boric Acid Fuses

Medium Voltage

BBU

Time Current Characteristics

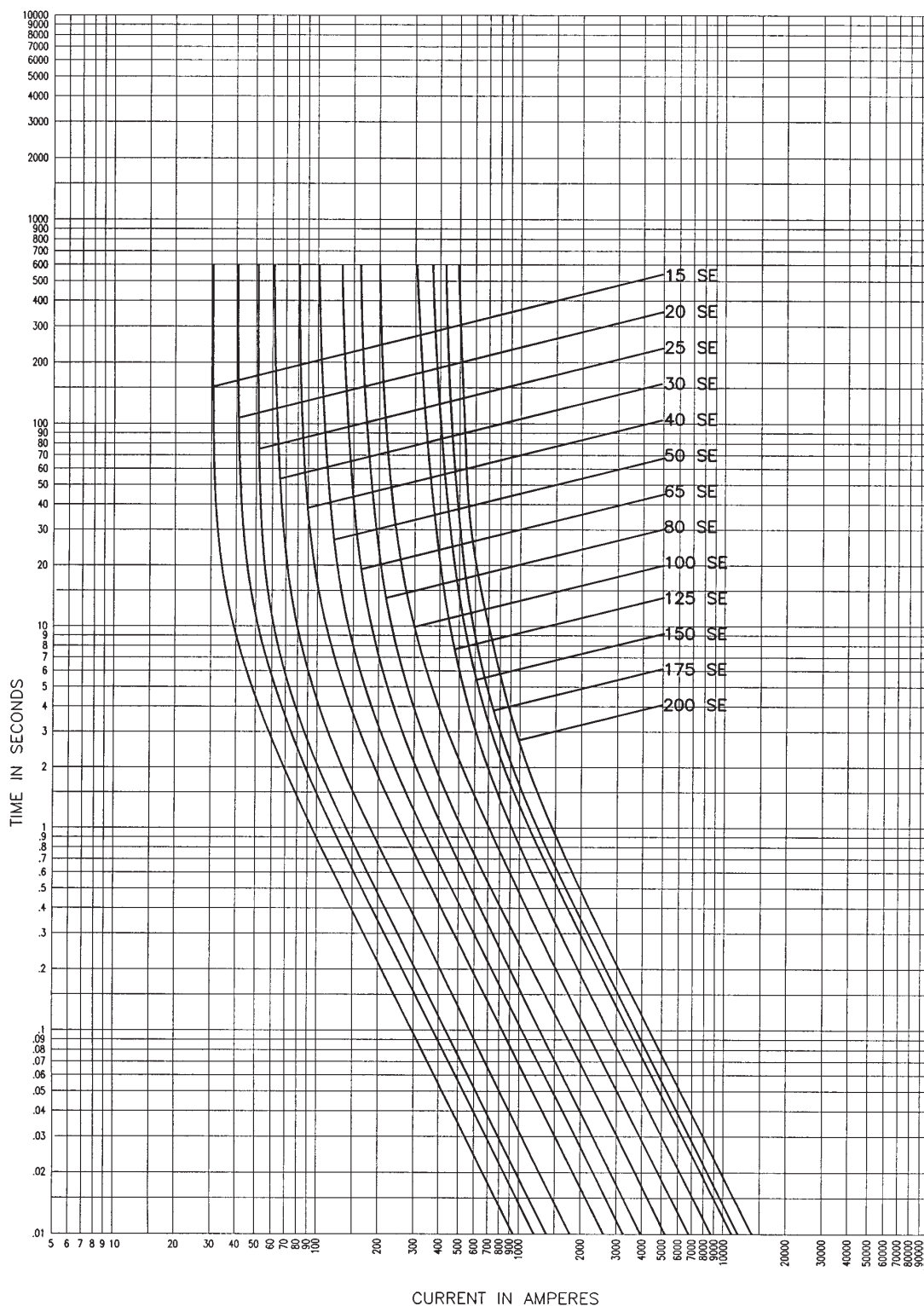

Type BBU Slow E Speed Fuses
 Minimum Melting Time-Current Characteristics - 17.1 to 38 kV
 Curves are based on tests starting with fuse unit at ambient temperature of 25 C and without initial load. Curves are plotted to minimum test points so all variations should be positive.

Boric Acid Fuses

Medium Voltage

BBU

Time Current Characteristics

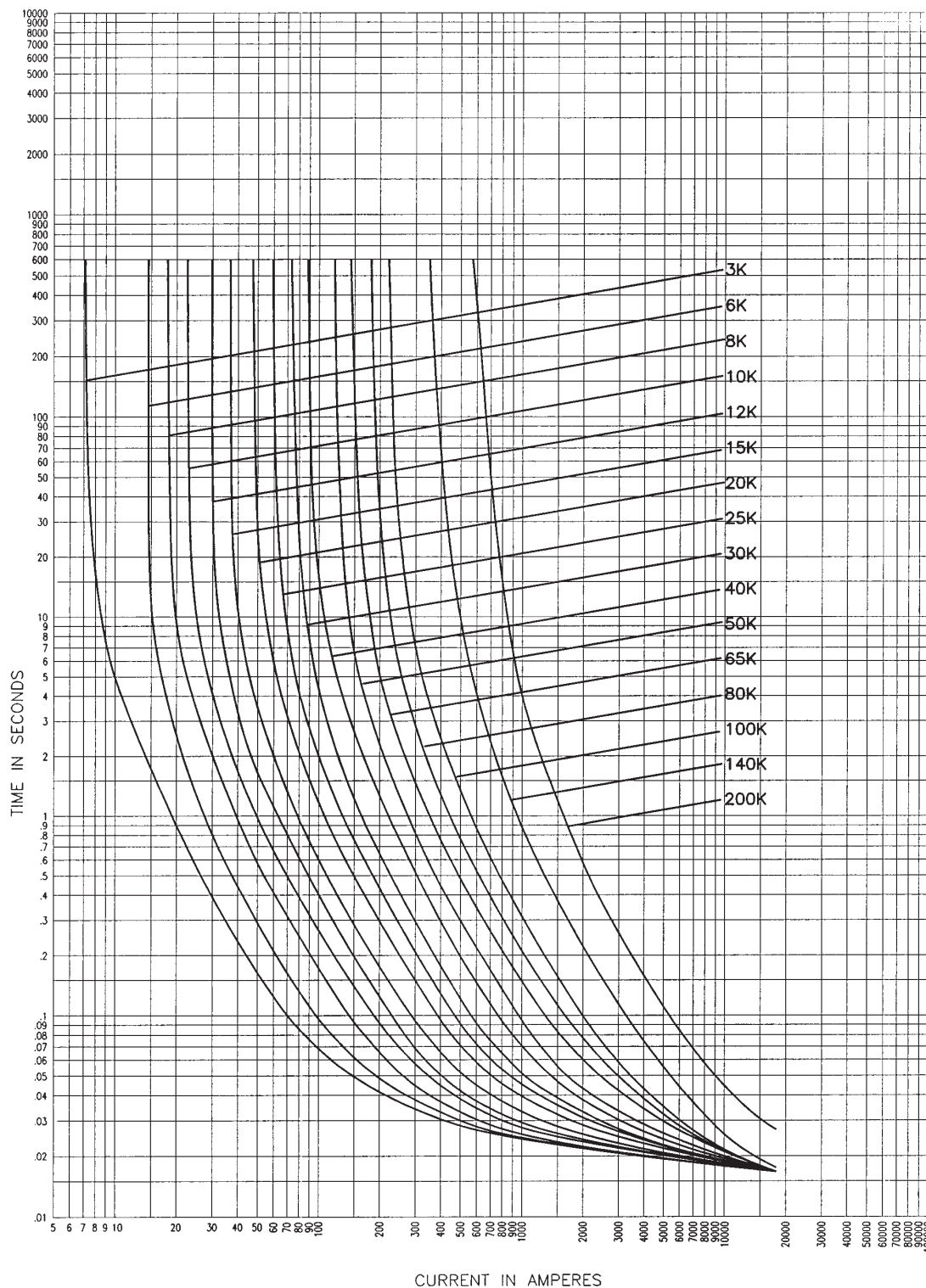

Type BBU Standard K Speed Fuses
 Total Clear Time-Current Characteristics - 17.1 kV
 Curves are based on tests starting with fuse unit at ambient temperature of 25 C and without initial load. Curves are plotted to maximum test points so all variations should be negative.

Boric Acid Fuses

Medium Voltage

BBU

Time Current Characteristics

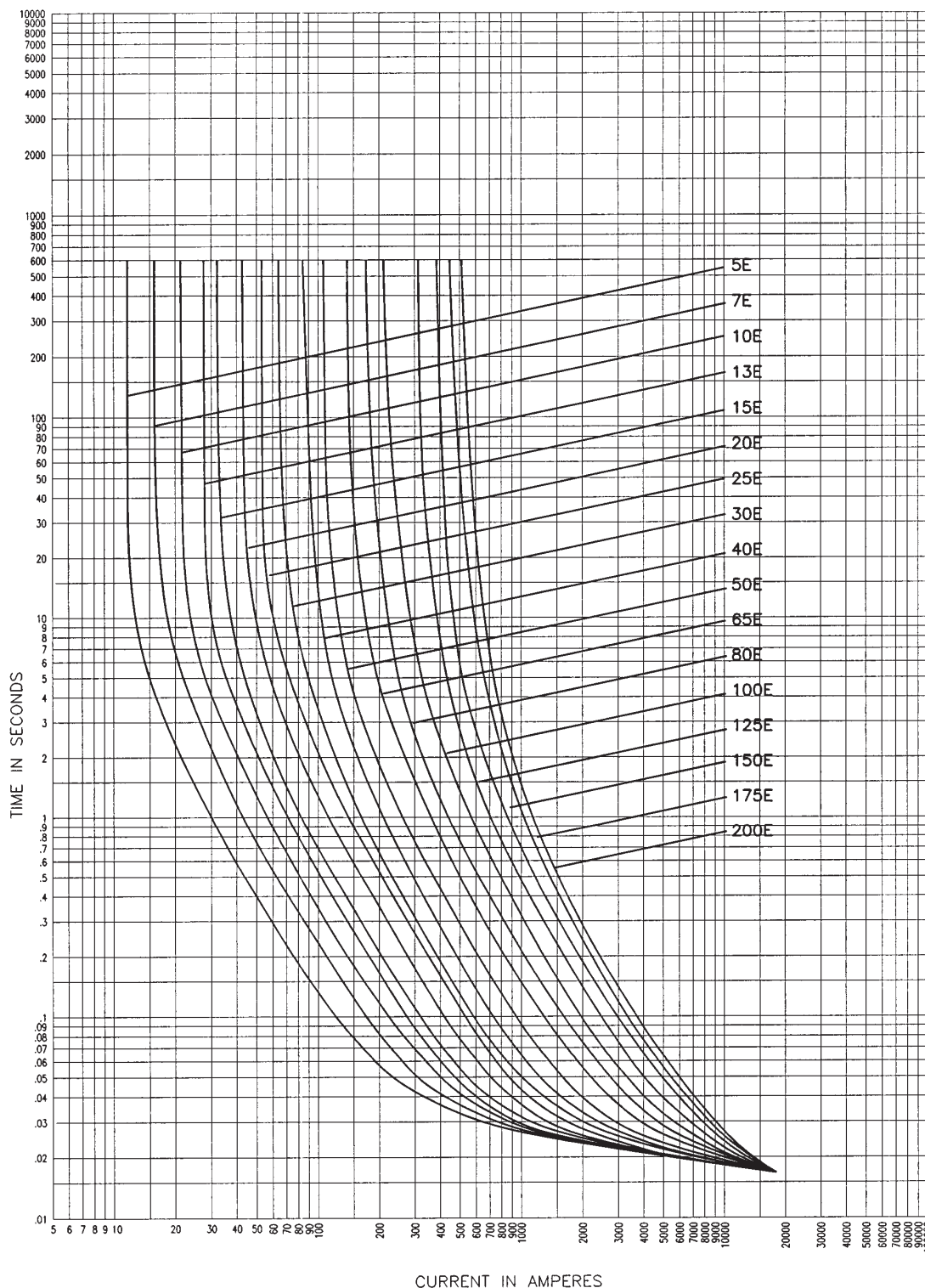

Type BBU Standard E Speed Fuses
 Total Clear Time-Current Characteristics - 17.1 kV
 Curves are based on tests starting with fuse unit at ambient temperature of 25 C and without initial load. Curves are plotted to maximum test points so all variations should be negative.

Boric Acid Fuses

Medium Voltage

BBU

Time Current Characteristics

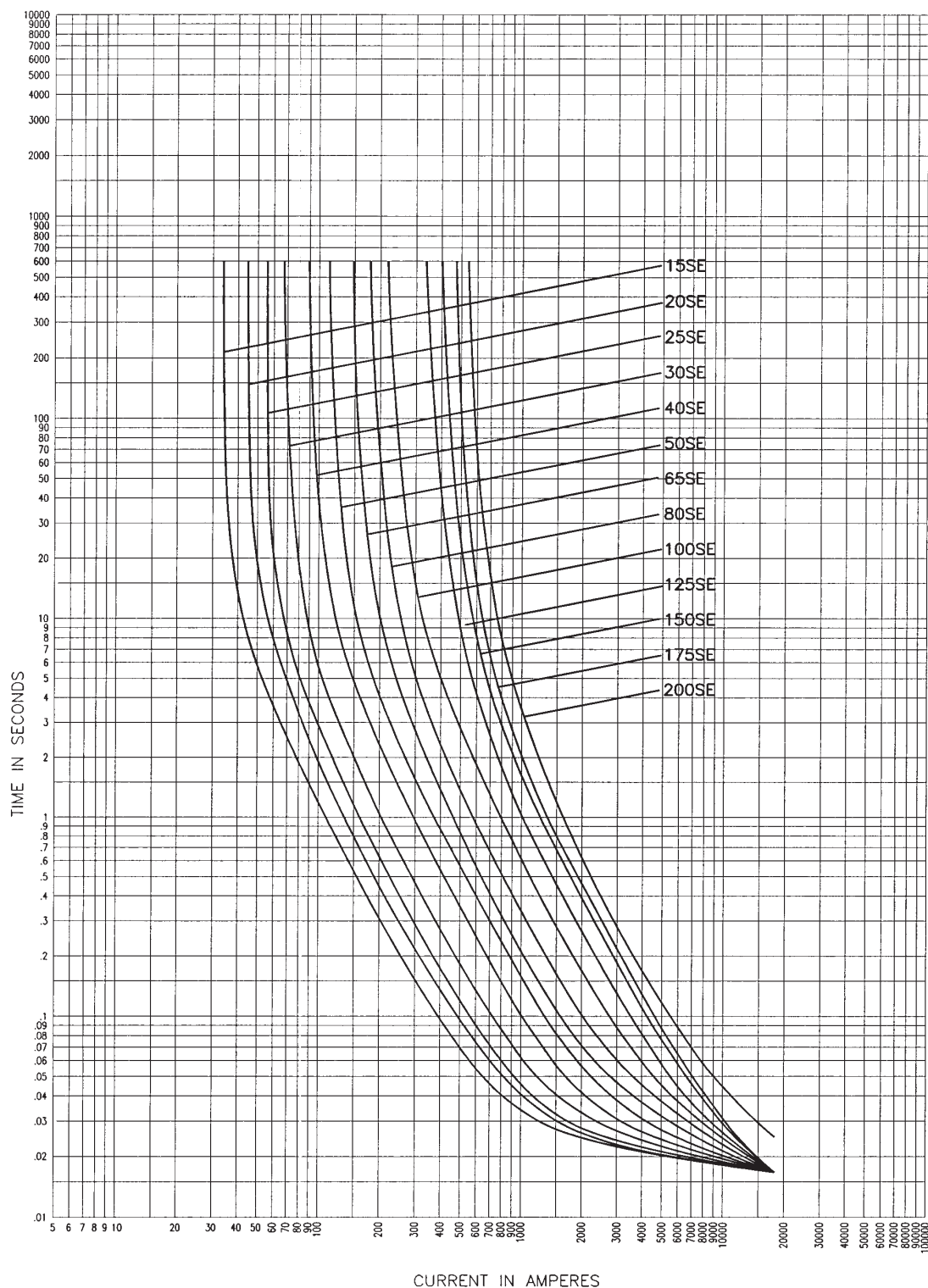

Type BBU Slow E Speed Fuses
 Total Clear Time-Current Characteristics - 17.1 kV
 Curves are based on tests starting with fuse unit at ambient temperature of 25 C and without initial load. Curves are plotted to maximum test points so all variations should be negative.

Boric Acid Fuses

Medium Voltage

BBU

Time Current Characteristics

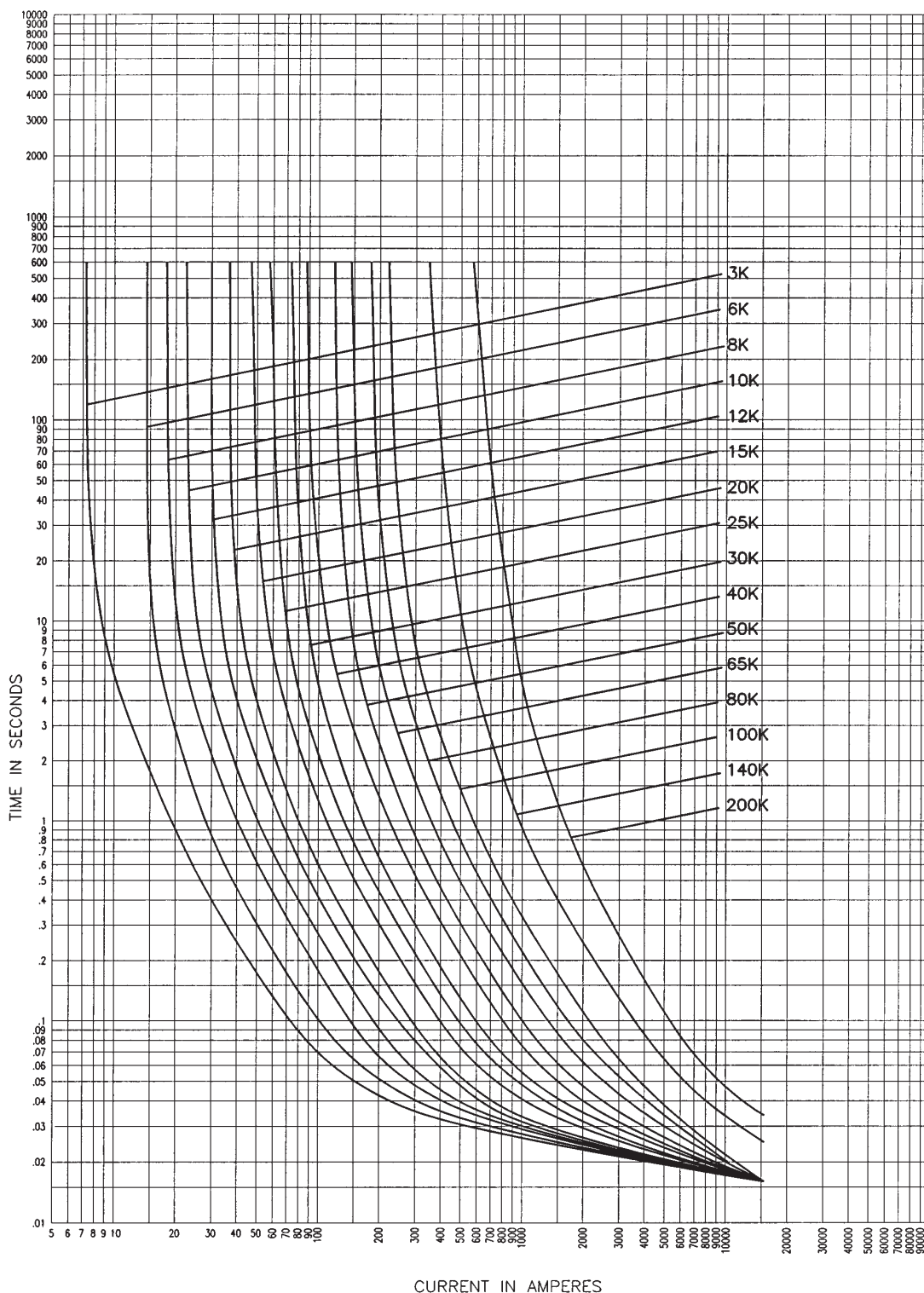

Type BBU Standard K Speed Fuses
 Total Clearing Time-Current Characteristics - 27 and 38 kV
 Curves are based on tests starting with fuse unit at ambient temperature of 25 C and without initial load. Curves are plotted to maximum test points so all variations should be negative.

Boric Acid Fuses

Medium Voltage

BBU

Time Current Characteristics

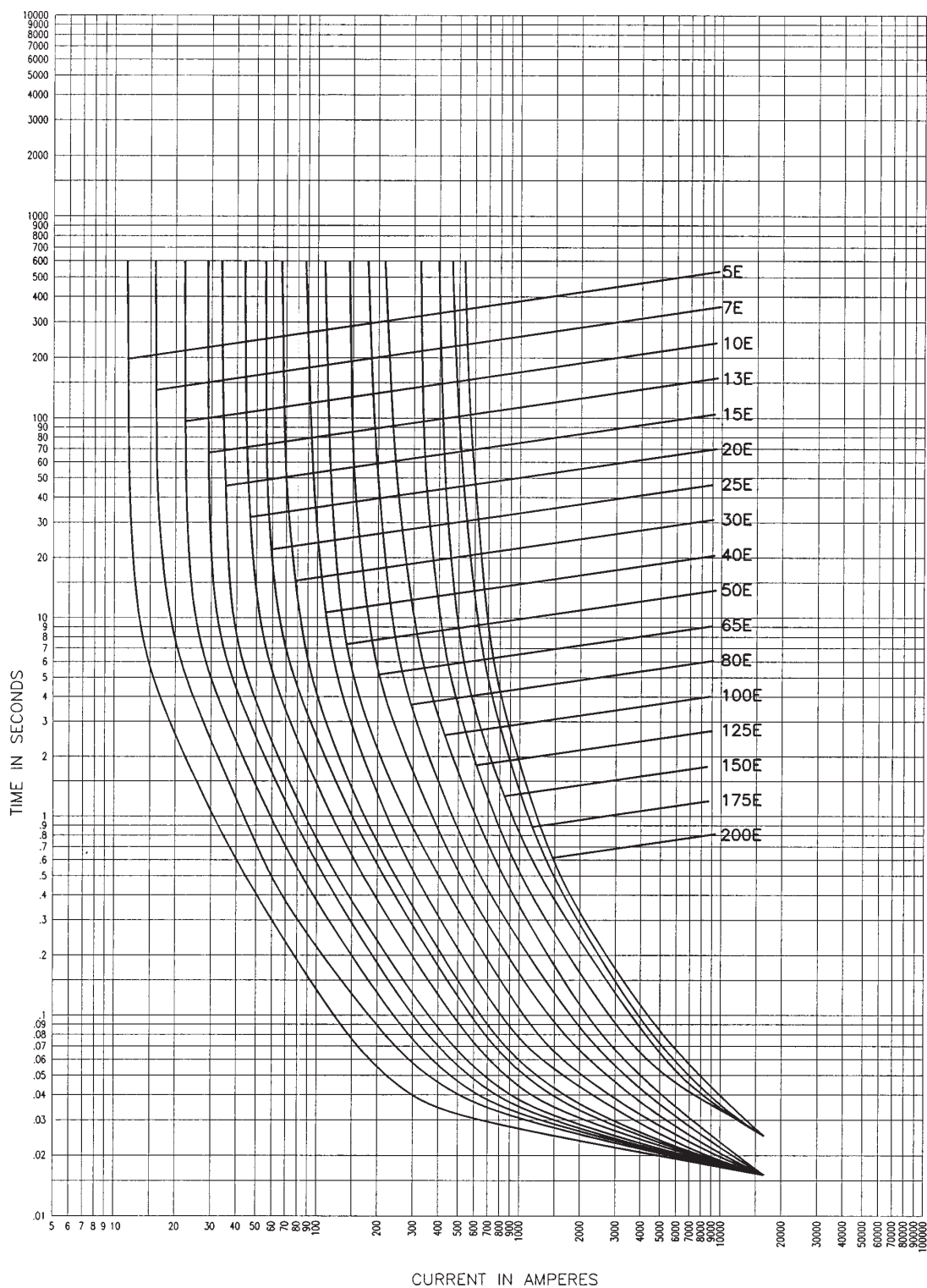

Type BBU Standard E Speed Fuses
 Total Clearing Time-Current Characteristics - 27 and 38 kV
 Curves are based on tests starting with fuse unit at ambient temperature of 25 C and without initial load. Curves are plotted to maximum test points so all variations should be negative.

Boric Acid Fuses

Medium Voltage

BBU

Time Current Characteristics

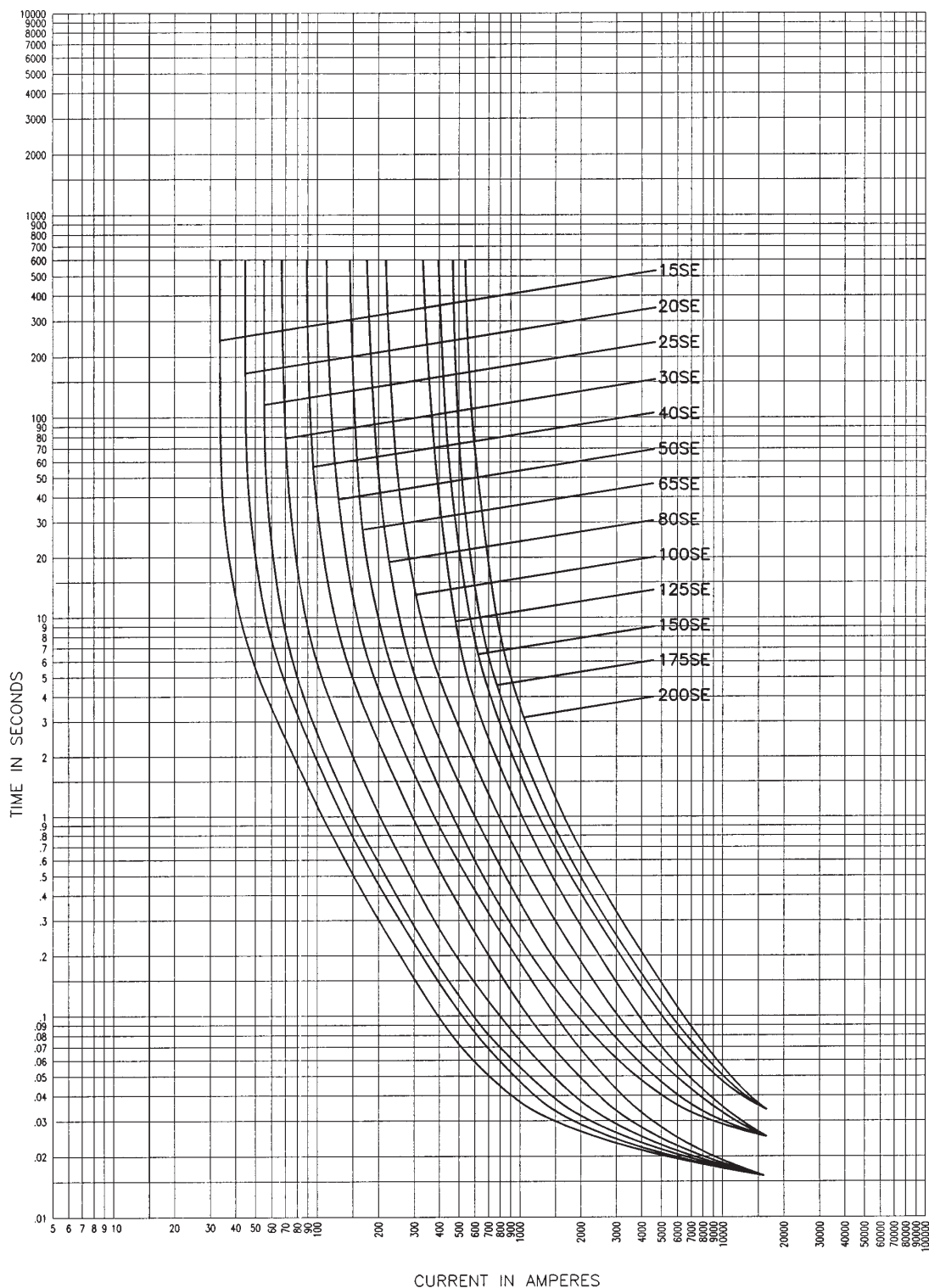

Type BBU Slow E Speed Fuses
 Total Clearing Time-Current Characteristics -- 27 and 38 kV
 Curves are based on tests starting with fuse unit at ambient temperature of 25 C and without initial load. Curves are plotted to maximum test points so all variations should be negative.

Boric Acid Fuses

Medium Voltage

BBU

BBU Cross Reference Charts

Bussmann®	S & C	Bussmann®	S & C	Bussmann®	S & C
BBU17-3K	702003	BBU27-3K	703003	BBU38-3K	704003
BBU17-6K	702006	BBU27-6K	703006	BBU38-6K	704006
BBU17-8K	702008	BBU27-8K	703008	BBU38-8K	704008
BBU17-10K	702010	BBU27-10K	703010	BBU38-10K	704010
BBU17-12K	702012	BBU27-12K	703012	BBU38-12K	704012
BBU17-15K	702015	BBU27-15K	703015	BBU38-15K	704015
BBU17-20K	702020	BBU27-20K	703020	BBU38-20K	704020
BBU17-25K	702025	BBU27-25K	703025	BBU38-25K	704025
BBU17-30K	702030	BBU27-30K	703030	BBU38-30K	704030
BBU17-40K	702040	BBU27-40K	703040	BBU38-40K	704040
BBU17-50K	702050	BBU27-50K	703050	BBU38-50K	704050
BBU17-65K	702065	BBU27-65K	703065	BBU38-65K	704065
BBU17-80K	702080	BBU27-80K	703080	BBU38-80K	704080
BBU17-100K	702100	BBU27-100K	703100	BBU38-100K	704100
BBU17-140K	702140	BBU27-140K	703140	BBU38-140K	704140
BBU17-200K	702200	BBU27-200K	703200	BBU38-200K	704200
BBU17-5E	612005	BBU27-5E	613005	BBU38-5E	614005
BBU17-7E	612007	BBU27-7E	613007	BBU38-7E	614007
BBU17-10E	612010t	BBU27-10E	613010	BBU38-10E	614010
BBU17-13E	612013	BBU27-13E	613013	BBU38-13E	614013
BBU17-15E	612015	BBU27-15E	613015	BBU38-15E	614015
BBU17-20E	612020	BBU27-20E	613020	BBU38-20E	614020
BBU17-25E	612025	BBU27-25E	613025	BBU38-25E	614025
BBU17-30E	612030	BBU27-30E	613030	BBU38-30E	614030
BBU17-40E	612040	BBU27-40E	613040	BBU38-40E	614040
BBU17-50E	612050	BBU27-50E	613050	BBU38-50E	614050
BBU17-65E	612065	BBU27-65E	613065	BBU38-65E	614065
BBU17-80E	612080	BBU27-80E	613080	BBU38-80E	614080
BBU17-100E	612100	BBU27-100E	613100	BBU38-100E	614100
BBU17-125E	612125	BBU27-125E	613125	BBU38-125E	614125
BBU17-150E	612150	BBU27-150E	613150	BBU38-150E	614150
BBU17-175E	612175	BBU27-175E	613175	BBU38-175E	614175
BBU17-200E	612200	BBU27-200E	613200	BBU38-200E	614200
BBU17-15SE	712015	BBU27-15SE	713015	BBU38-15SE	714015
BBU17-20SE	712020	BBU27-20SE	713020	BBU38-20SE	714020
BBU17-25SE	712025	BBU27-25SE	713025	BBU38-25SE	714025
BBU17-30SE	712030	BBU27-30SE	713030	BBU38-30SE	714030
BBU17-40SE	712040	BBU27-40SE	713040	BBU38-40SE	714040
BBU17-50SE	712050	BBU27-50SE	713050	BBU38-50SE	714050
BBU17-65SE	712065	BBU27-65SE	713065	BBU38-65SE	714065
BBU17-80SE	712080	BBU27-180SE	713080	BBU38-80SE	714080
BBU17-100SE	712100	BBU27-100SE	713100	BBU38-100SE	714100
BBU17-125SE	712125	BBU27-125SE	713125	BBU38-125SE	714125
BBU17-150SE	712150	BBU27-150SE	713150	BBU38-150SE	714150
BBU17-175SE	712175	BBU27-175SE	713175	BBU38-175SE	714175
BBU17-200SE	712200	BBU27-200SE	713200	BBU38-200SE	714200
				BBU-EFID	3097