

Descriptions

- General purpose application
- Switching application

Features

- Large collector current
- Low collector saturation voltage
- Complementary pair with STN2222A

PIN Connection

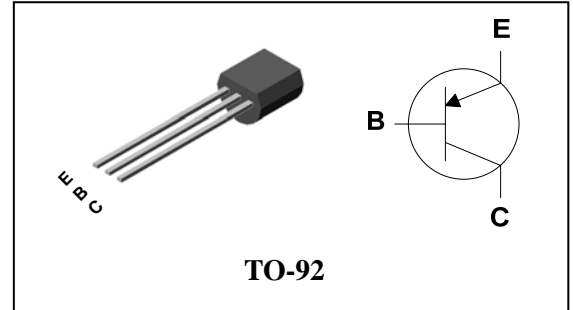

Ordering Information

| Type NO. | Marking | Package Code |
|----------|----------|--------------|
| STN2907A | STN2907A | TO-92 |

Absolute maximum ratings

 $T_a=25^{\circ}\text{C}$

| Characteristic | Symbol | Ratings | Unit |
|---------------------------|-----------|-----------|--------------------|
| Collector-Base voltage | V_{CBO} | -60 | V |
| Collector-Emitter voltage | V_{CEO} | -50 | V |
| Emitter-base voltage | V_{EBO} | -5 | V |
| Collector current | I_C | -600 | mA |
| Collector dissipation | P_C | 625 | mW |
| Junction temperature | T_j | 150 | $^{\circ}\text{C}$ |
| Storage temperature | T_{stg} | -55 ~ 150 | $^{\circ}\text{C}$ |

Electrical Characteristics

 $T_a=25^{\circ}\text{C}$

| Characteristic | Symbol | Test Condition | Min. | Typ. | Max. | Unit |
|--------------------------------------|---------------|--|------|------|------|------|
| Collector-Base breakdown voltage | BV_{CBO} | $I_C=-10\mu\text{A}$, $I_E=0$ | -60 | - | - | V |
| Collector-Emitter breakdown voltage | BV_{CEO} | $I_C=-1\text{mA}$, $I_B=0$ | -50 | - | - | V |
| Emitter-Base breakdown voltage | BV_{EBO} | $I_E=-10\mu\text{A}$, $I_C=0$ | -5 | - | - | V |
| Collector cut-off current | I_{CBO} | $V_{CB}=-50\text{V}$, $I_E=0$ | - | - | -10 | nA |
| DC current gain | h_{FE} | $V_{CE}=-10\text{V}$, $I_C=-10\text{mA}$ | 100 | - | - | - |
| Collector-Emitter saturation voltage | $V_{CE(sat)}$ | $I_C=-150\text{mA}$, $I_B=-15\text{mA}$ | - | - | -0.4 | V |
| Transistor frequency | f_T | $V_{CE}=-20\text{V}$, $I_C=-20\text{mA}$ | 200 | - | - | MHz |
| Collector output capacitance | C_{ob} | $V_{CB}=-10\text{V}$, $I_E=0$, $f=1\text{MHz}$ | - | 6.0 | - | pF |

Electrical Characteristic Curves

Fig. 1 P_C - T_a

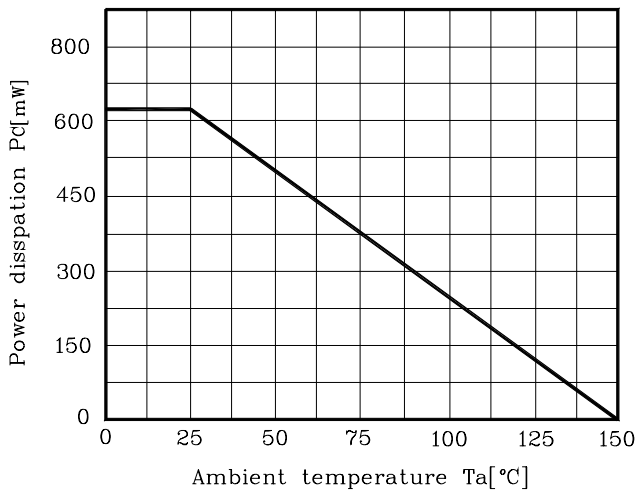

Fig. 2 I_C - V_{BE}

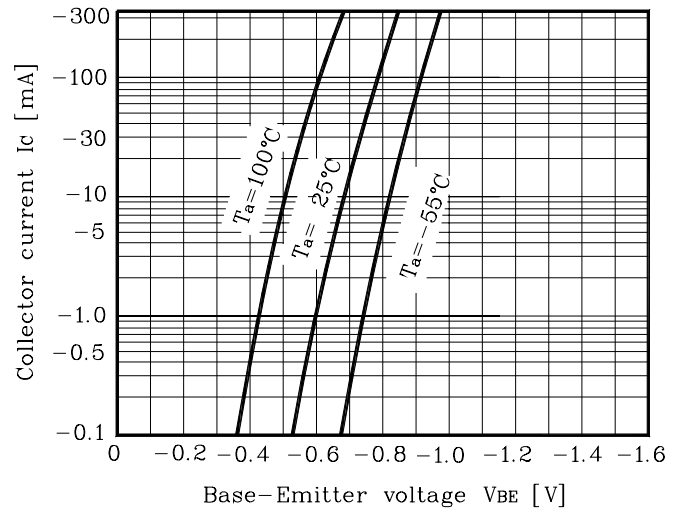

Fig. 3 I_C - V_{CE}

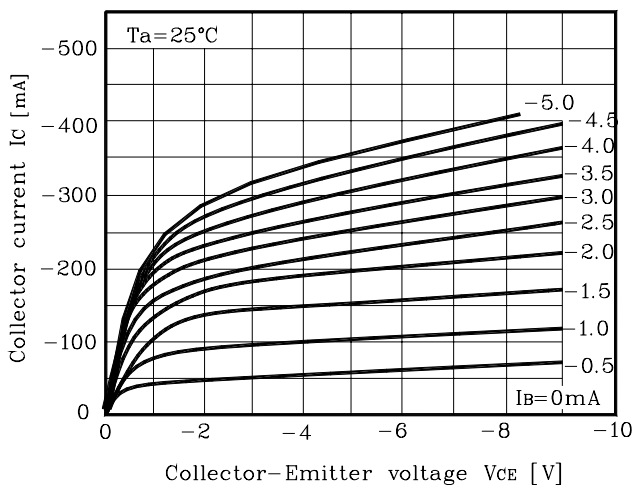

Fig. 4 $V_{CE(sat)}$ - I_C

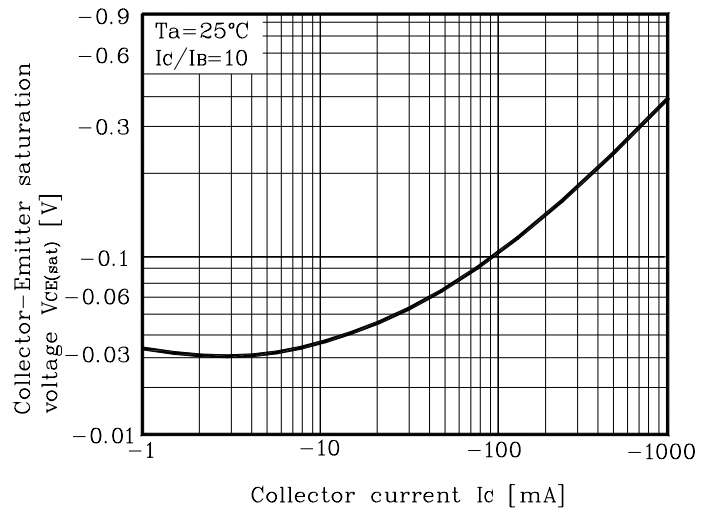

Fig. 5 h_{FE} - I_C

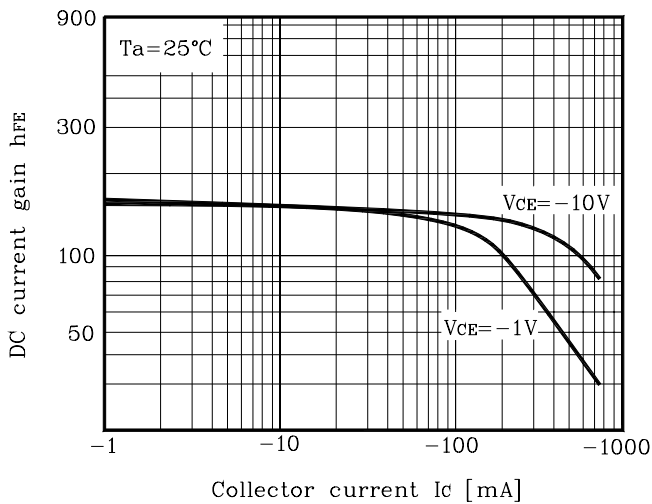
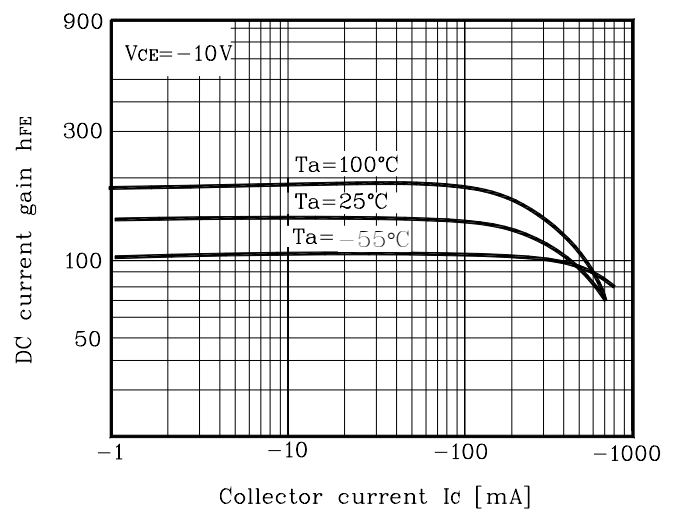
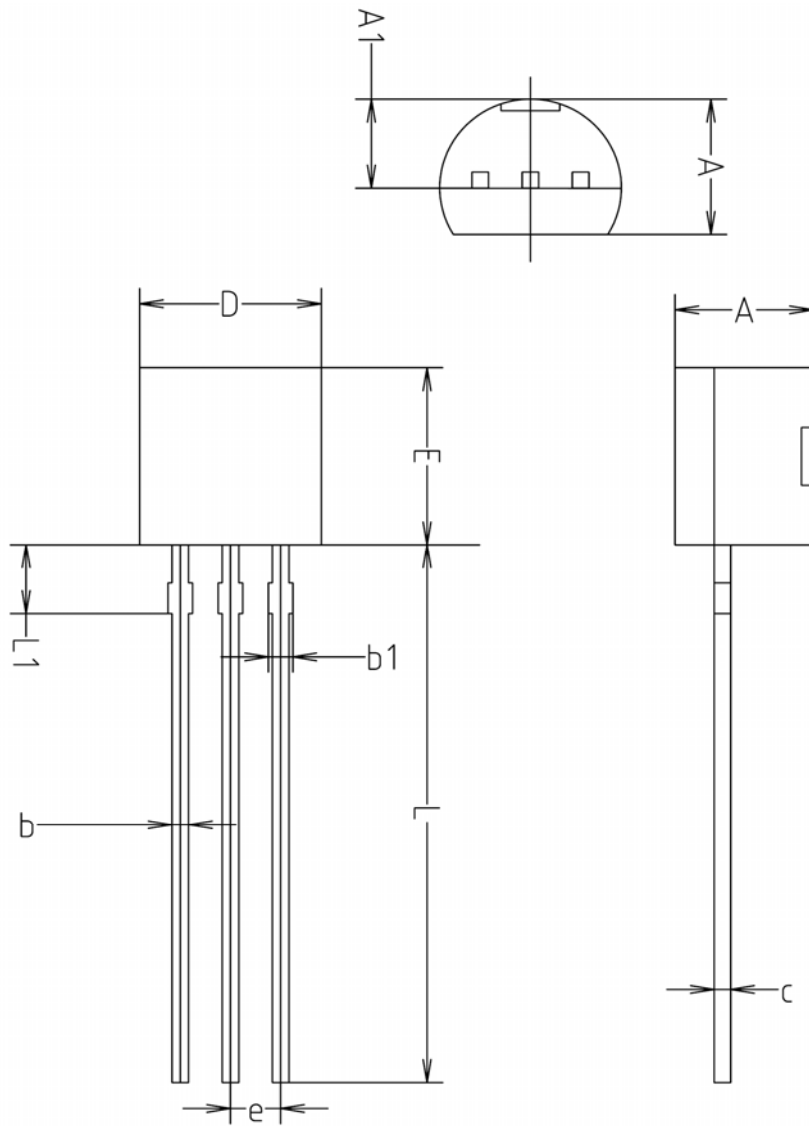

Fig. 6 h_{FE} - I_C



Outline Dimension



| SYMBOL | MILLMETERS(mm) | | |
|--------|----------------|---------|---------|
| | MINIMUM | NOMINAL | MAXIMUM |
| A | 3.40 | 3.50 | 3.66 |
| A1 | 2.46 | 2.51 | 2.59 |
| b | 0.39 | 0.44 | 0.53 |
| b1 | 0.39 | — | 0.63 |
| c | 0.35 | 0.42 | 0.47 |
| D | 4.48 | 4.60 | 4.70 |
| E | 4.48 | 4.60 | 4.70 |
| e | 1.17 | 1.27 | 1.37 |
| L | 13.70 | 14.00 | 14.77 |
| L1 | 1.55 | 1.70 | 2.15 |

The AUK Corp. products are intended for the use as components in general electronic equipment (Office and communication equipment, measuring equipment, home appliance, etc.).

Please make sure that you consult with us before you use these AUK Corp. products in equipments which require high quality and / or reliability, and in equipments which could have major impact to the welfare of human life(atomic energy control, airplane, spaceship, transportation, combustion control, all types of safety device, etc.). AUK Corp. cannot accept liability to any damage which may occur in case these AUK Corp. products were used in the mentioned equipments without prior consultation with AUK Corp..

Specifications mentioned in this publication are subject to change without notice.