

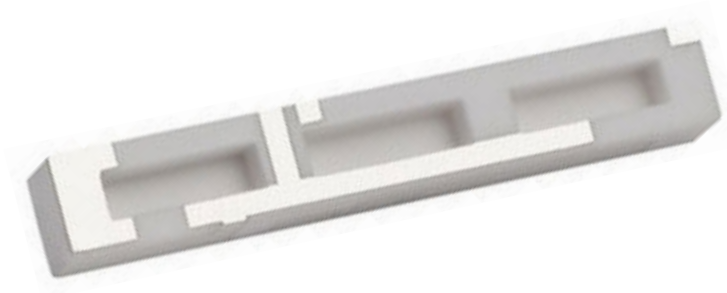

Front



Back

Viking

PA.700.J

Specification

Part No.	PA.700.J
Product Name	Viking Hexa-Band Cellular SMD Antenna
Feature	<p>Designed for Japan LTE frequency bands Covers all in one 2G/3G/4G applications 700~2600MHz LTE / GSM / CDMA / DCS / PCS / WCDMA / UMTS / HSDPA / GPRS / EDGE High efficiency wide-band antenna Patent pending SMT for precision mounting and labor saving 40*6*5mm RoHS Compliant</p>



1. Introduction

This revolutionary patent pending PA.700J is a 2G/3G/4G high efficiency SMD ceramic antenna operating at 700MHz to 960MHz, 1400MHz to 2600MHz to cover all LTE

frequency bands applied in Japan. It uses high grade ceramics to deliver the highest efficiencies on all bands on the shortest device ground-plane

lengths possible. The exceptional wide-band response means it covers all standardly used operation bands around the globe.

1.1 Key Advantages

- 1. Highest efficiency in a small size, i.e. 40mm*6mm*5mm.**
A comparative metal, FR4, FPC, whip, rod, helix antenna, would have much more reduced efficiency in this configuration for the same size due to their different dielectric constants. Very high efficiency antennas are critical to 3G and 4G devices ability to deliver the stated data-speed rates of systems such as HSPA and LTE.
- 2. More resistant to detuning compared to other antenna integrations.**
If tuning is required it can be tuned for the device environment using a matching circuit or other techniques. There is no need for new tooling, thereby saving money if customization is required.
- 3. Highly reliable and robust**
Its predecessor the PA.25 antenna is used by the world's leading auto makers in extremely challenging environments. The antenna meets all temperature and mechanical specs required (vibration, drop tests etc)

- 4. Rectangular shape**
Easy to integrate. Other antenna designs come in irregular shapes and sizes making them hard to integrate.
- 5. SMD (On-Board)**
Antenna saves on labor, cable and connector costs, leads to higher integration yield rates, and reduces losses in transmission.
- 6. It mounts directly on edge of device main-board.**
- 7. Transmission losses are kept to absolute minimum**
Resulting in much improved over the air (OTA) TRP (Total Radiated Power) / TIS (Total Isotropic Radiation) device performance compared to similar efficiency cable and connector antenna solutions.
- 8. Reductions in probability of radiated spurious emissions**
Compared to other antenna technologies are observed when using the PA.700J and strictly following this application note layout

- 9. Achieves moderate to high gain in both vertical and horizontal polarization planes**
This feature is very useful in certain wireless communications where the antenna orientation is not fixed and the reflections or multipath signals may be present from any plane.

In those cases the important parameter to be considered is the total field strength, which is the vector sum of the signal from the horizontal and vertical polarization planes at any instant in time.

LTE Bands (Japan)		Frequency
1	2100	1920~2170MHz
6	800	830~885MHz
8	900	880~960MHz
9	1700	1749~1880MHz
11	1500	1427~1496MHz
18	800	815~875MHz
19	800	832~889MHz
21	1500	1447~1510MHz
41	2500	2496~2690MHz

2. Specification

Electrical

Antenna	PA700.J Viking				
Standard	2G/3G/4G				
Operation Frequency (MHz)	698~800MHz	824~960MHz	1410~1520MHz	1710~2170MHz	2400~2700MHz
Peak Gain	-3.6 dBi	-0.5 dBi	-1.0 dBi	0.5 dBi	2.7 dBi
Average Gain	-5.5 dB	-2.0 dB	-2.5 dB	-2.8 dB	-2.4 dB
Efficiency	30 %	63%	55 %	53%	57%
Return Loss [dB]	-5.0 dB	-14.0 dB	-7.0 dB	-7.0 dB	-7.5 dB
VSWR	<3.5:1				
Impedance	50Ω				
Polarization	Linear				
Radiation Properties	Omni-directional				
Max Input Power	5 W				

* The PA.700.J antenna performance was measured with 106.5x44 mm ground plane.

Mechanical

Dimensions (mm)	40 x 6 x 5 mm
Material	Ceramic
Termination	Ag (environmental-friendly Pb free)
EVB Connector	SMA-Female

Environmental

Operation Temperature	-40°C to 85°C
Storage Temperature	-40°C to 105°C
Relative Humidity	Non-condensing 65°C 95% RH
RoHs Compliant	Yes

* All electrical properties are measured with PA.700.J mounted on its EVB with 106.5x44mm ground.

2.1 Test Set Up



Figure 1. Impedance measurements (left hand) and peak gain, average gain, efficiency and radiation pattern measurements (right hand)

2.2 Return Loss

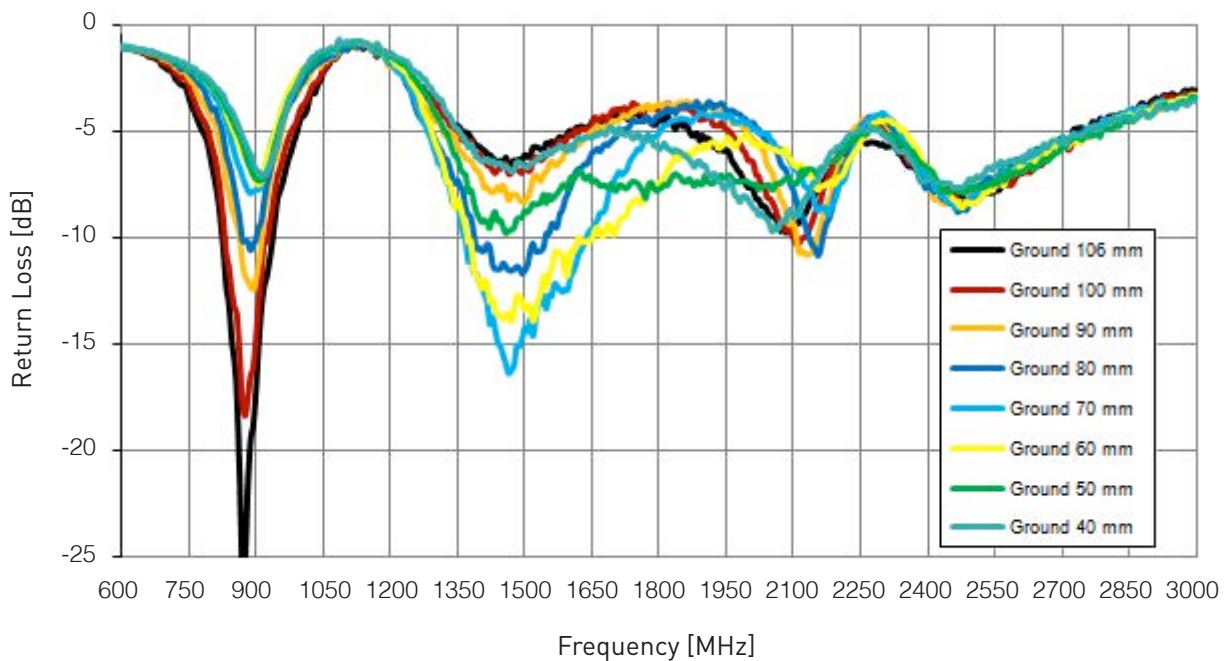

Figure 2. Return Loss of the PA700J LTE antenna

2.3 VSWR

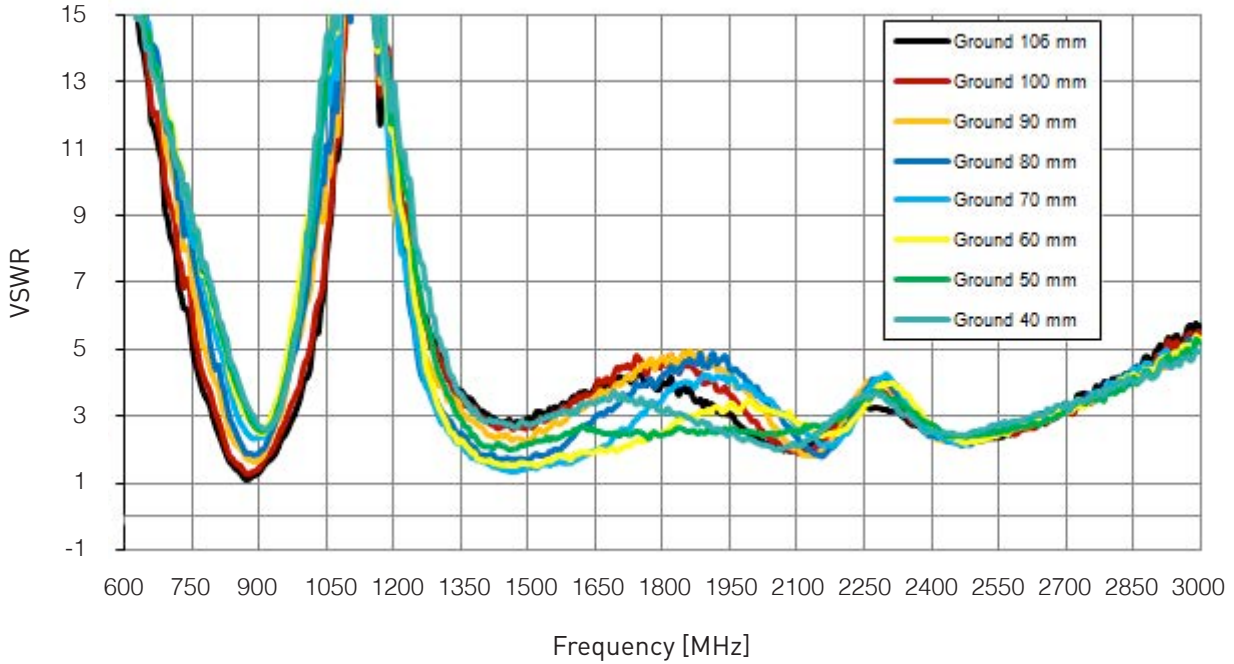

Figure 3. VSWR of the PA700.J LTE Antenna

2.4 Efficiency

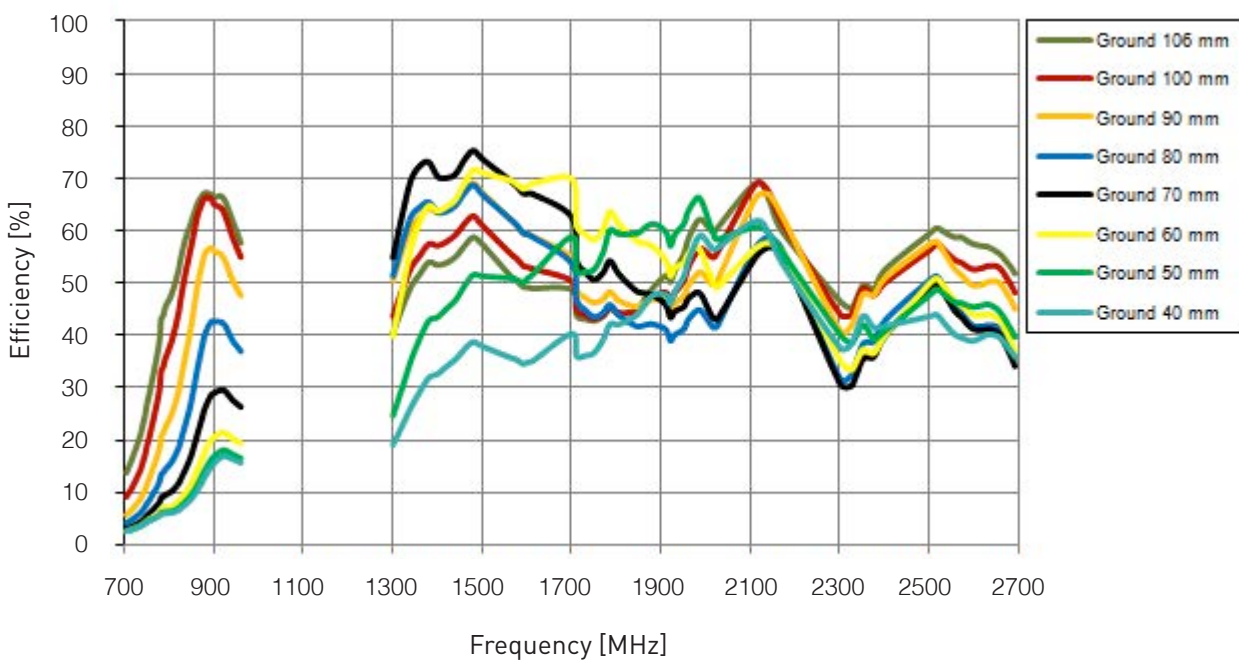

Figure 4. Efficiency of the PA700.J LTE Antenna

2.5 Peak Gain

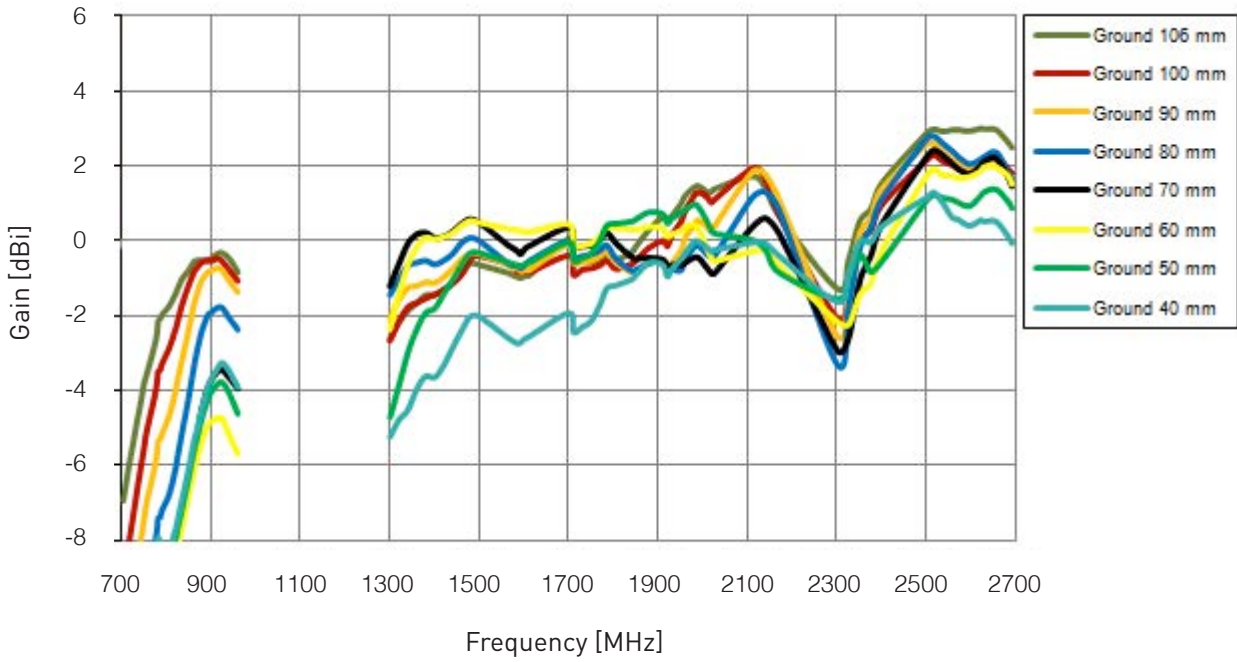

Figure 5. Peak Gain of the PA700.J LTE Antenna

2.6 Average Gain

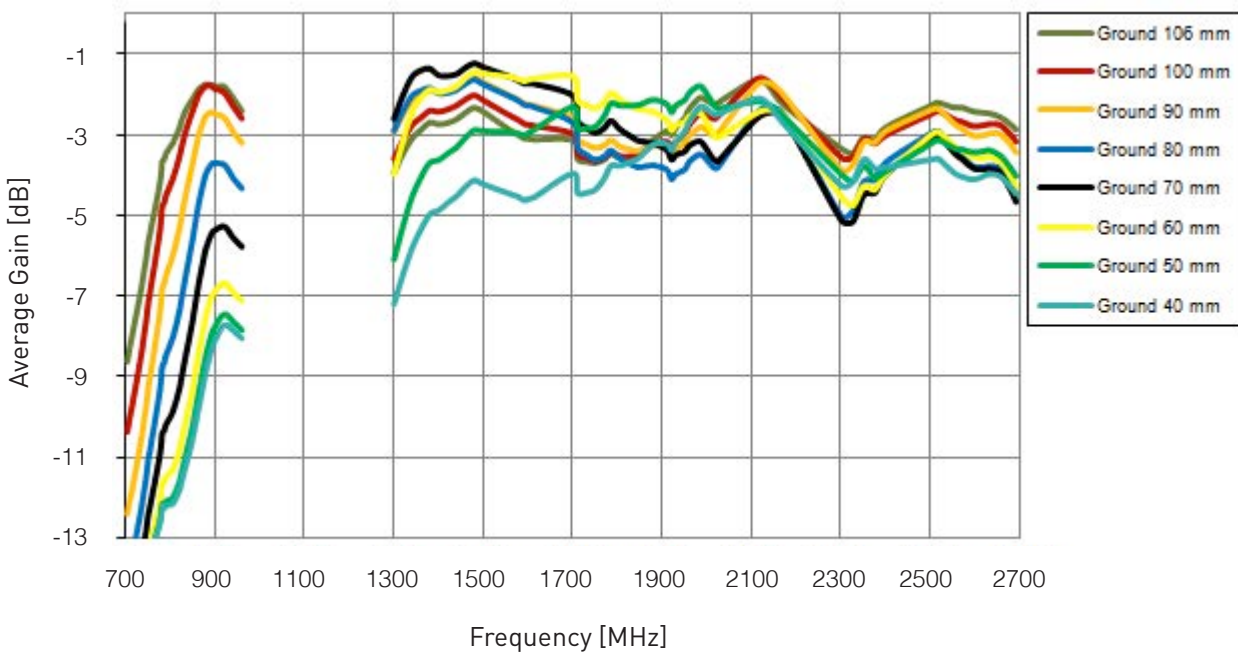

Figure 6. Average Gain of the PA700.J LTE Antenna

2.7 3D Radiation Pattern

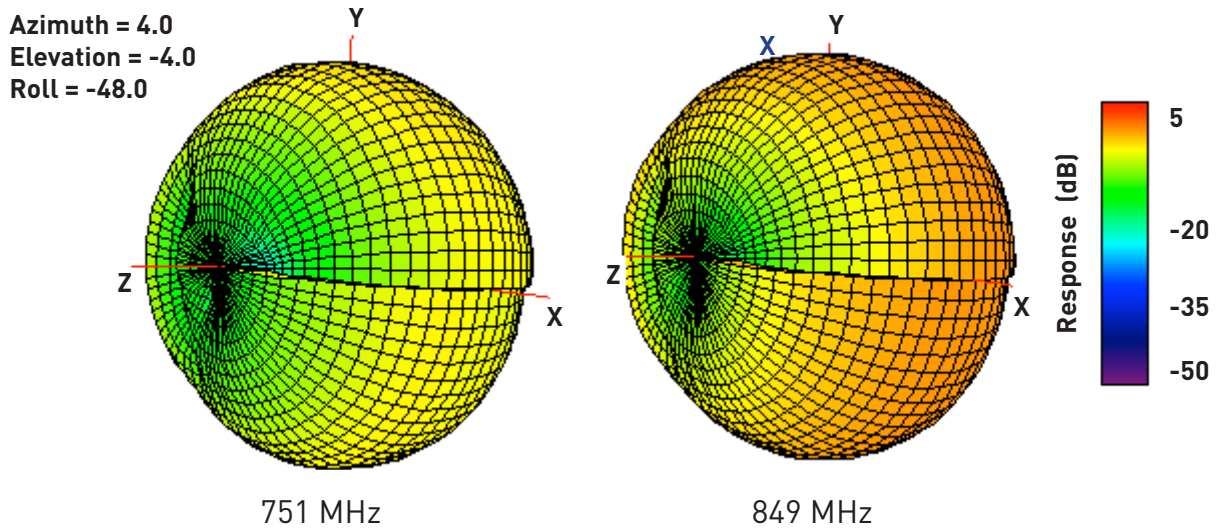

Figure 7. 3D Radiation Pattern at 751 MHz and 849 MHz of the PA700J Antenna.

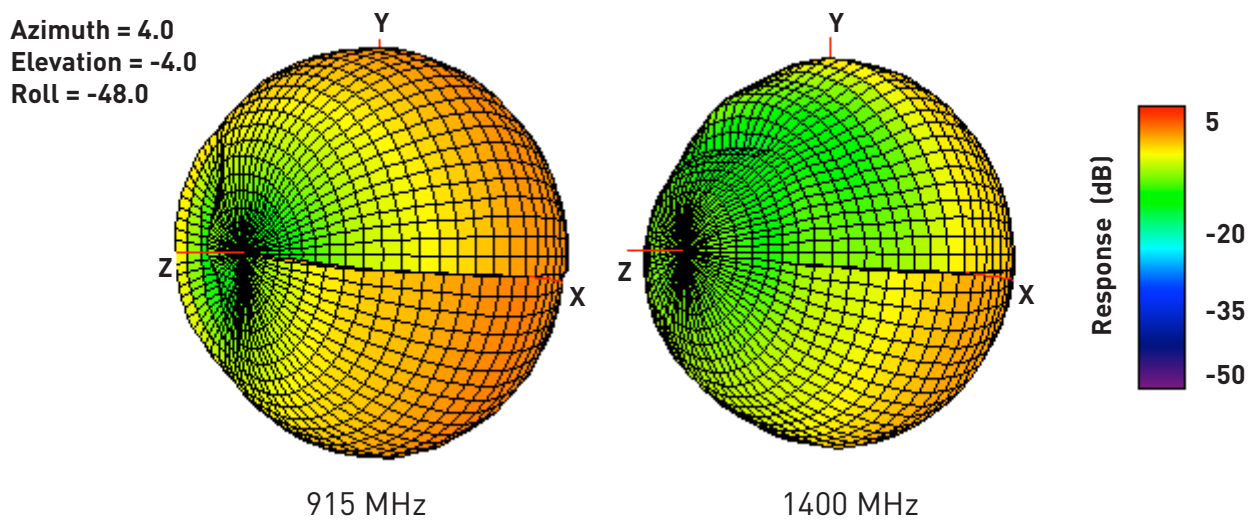

Figure 8. 3D Radiation Pattern at 915 MHz and 1400 MHz of the PA700J Antenna.

2.7 3D Radiation Pattern

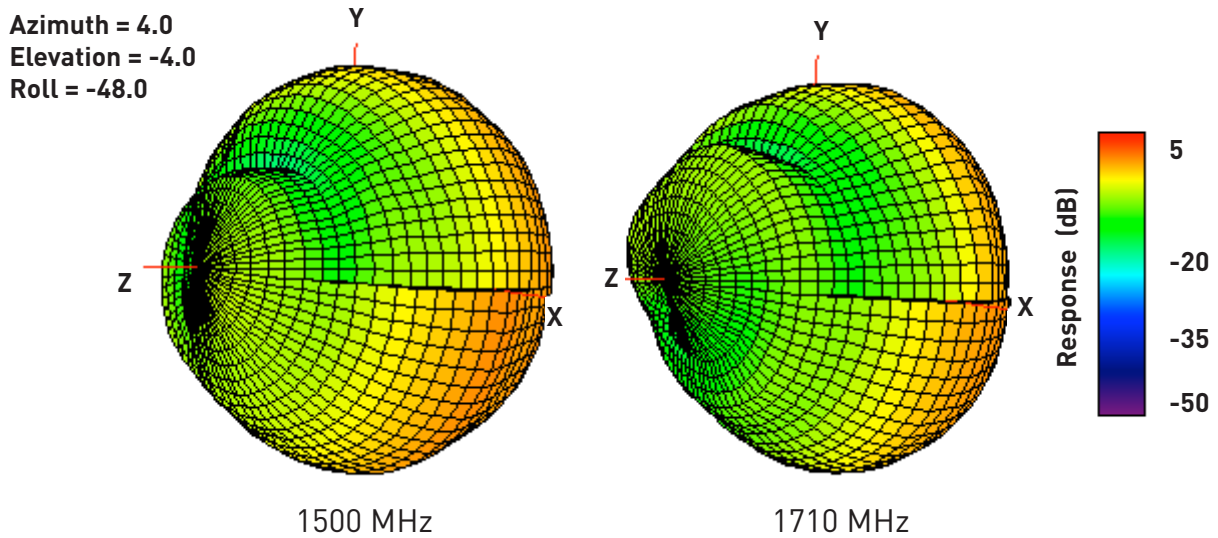

Figure 9. 3D Radiation Pattern at 1500 MHz and 1710 MHz of the PA700J Antenna.

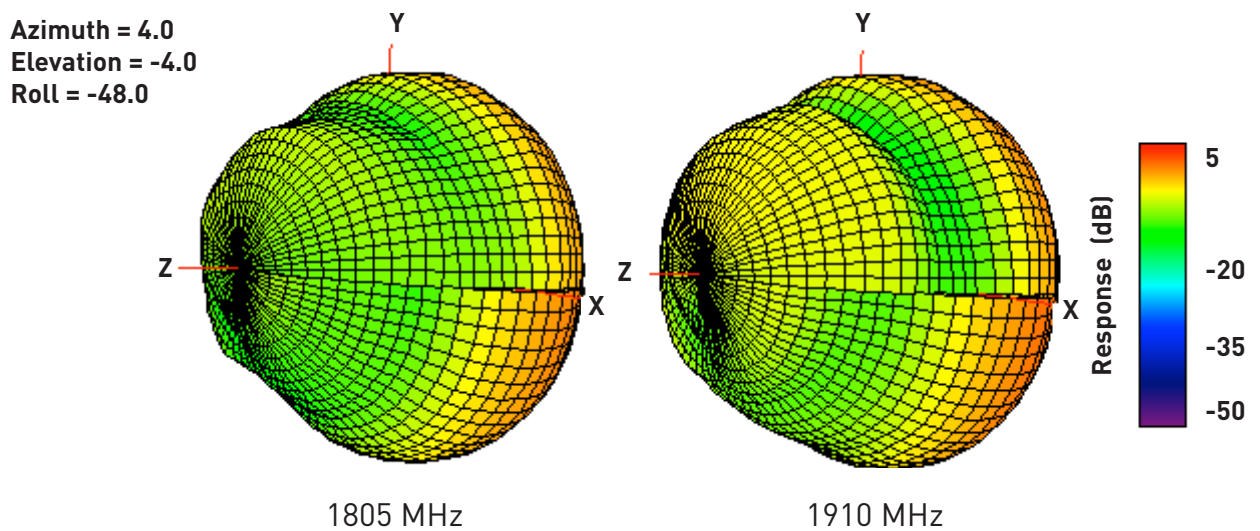

Figure 10. 3D Radiation Pattern at 1805 MHz and 1910 MHz of the PA700J Antenna.

2.7 3D Radiation Pattern

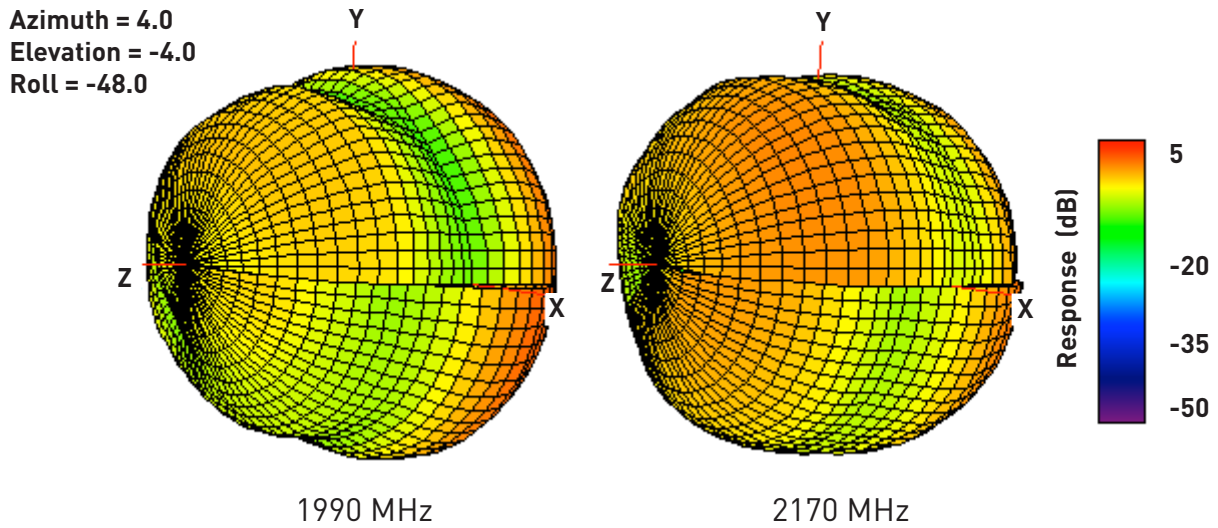

Figure 11. 3D Radiation Pattern at 1990 MHz and 2170 MHz of the PA700J Antenna.

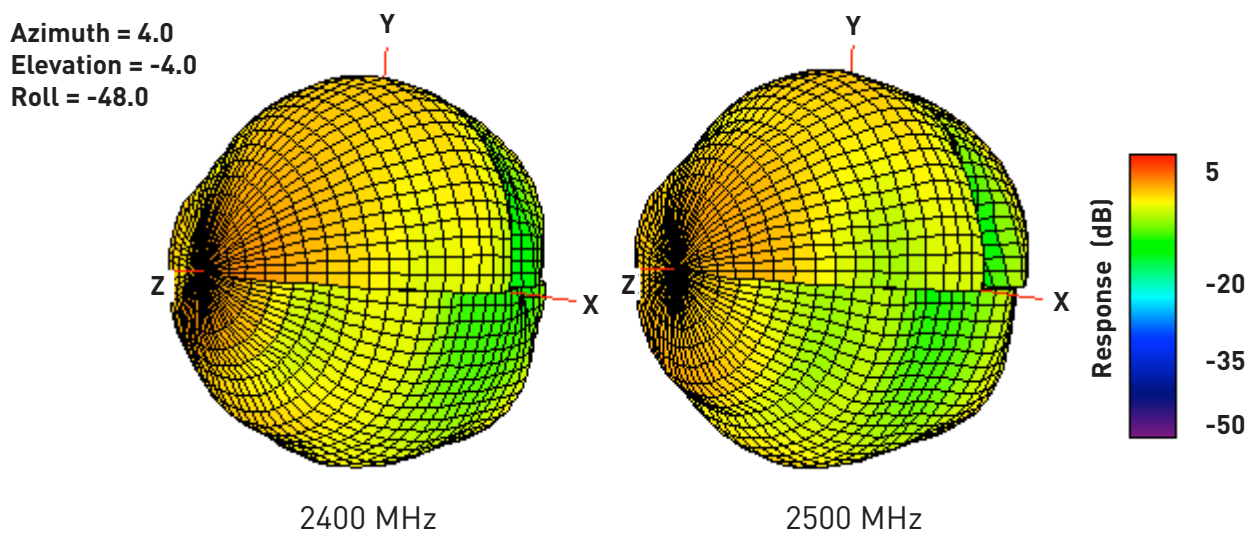
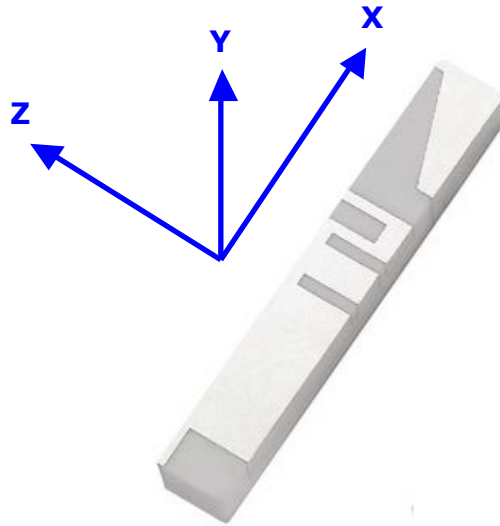
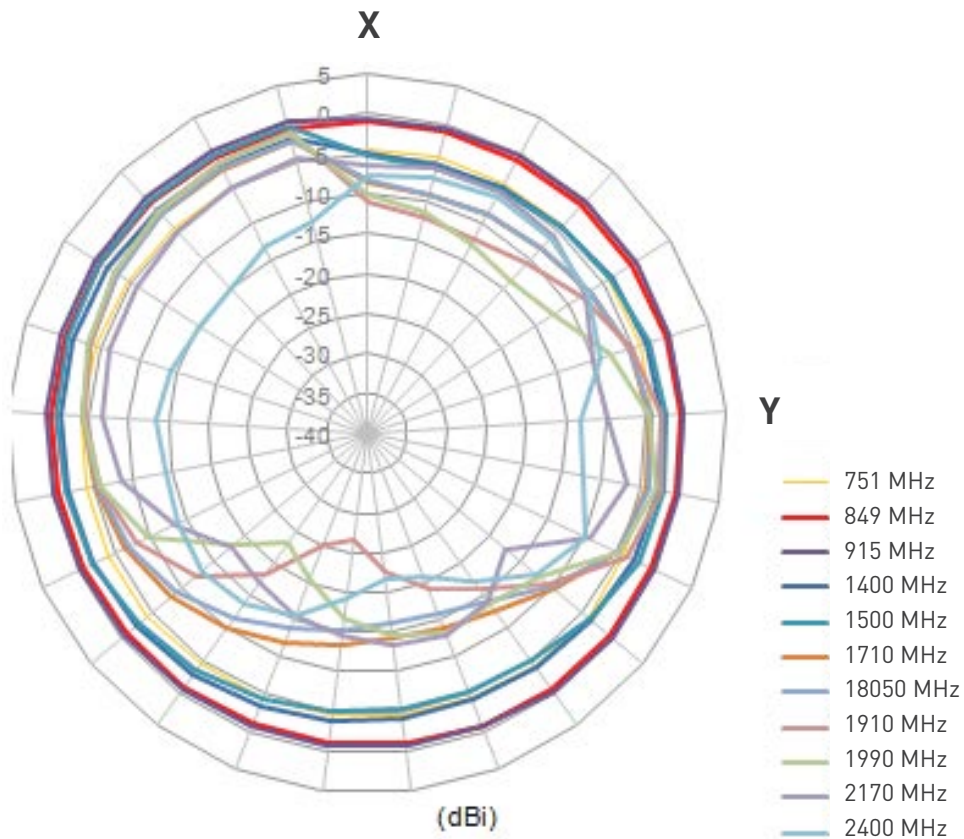

Figure 12. 3D Radiation Pattern at 2400 and 2500 MHz of the PA700J Antenna..

2.8 2D Radiation Pattern



XY Plane Radiation



XZ Plane Radiation

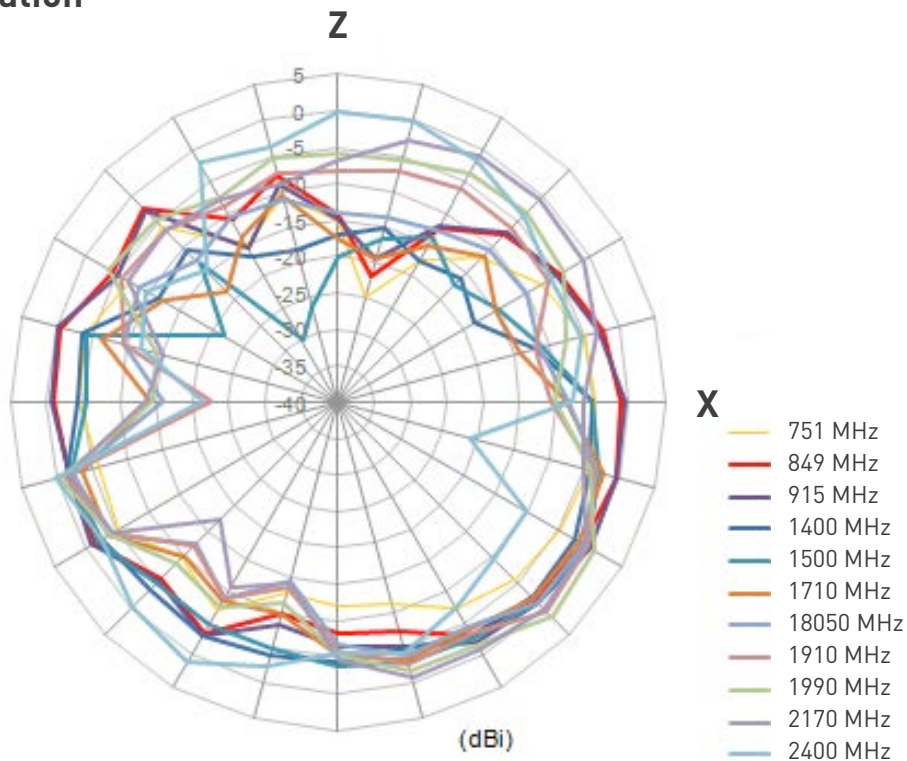

YZ Plane Radiation

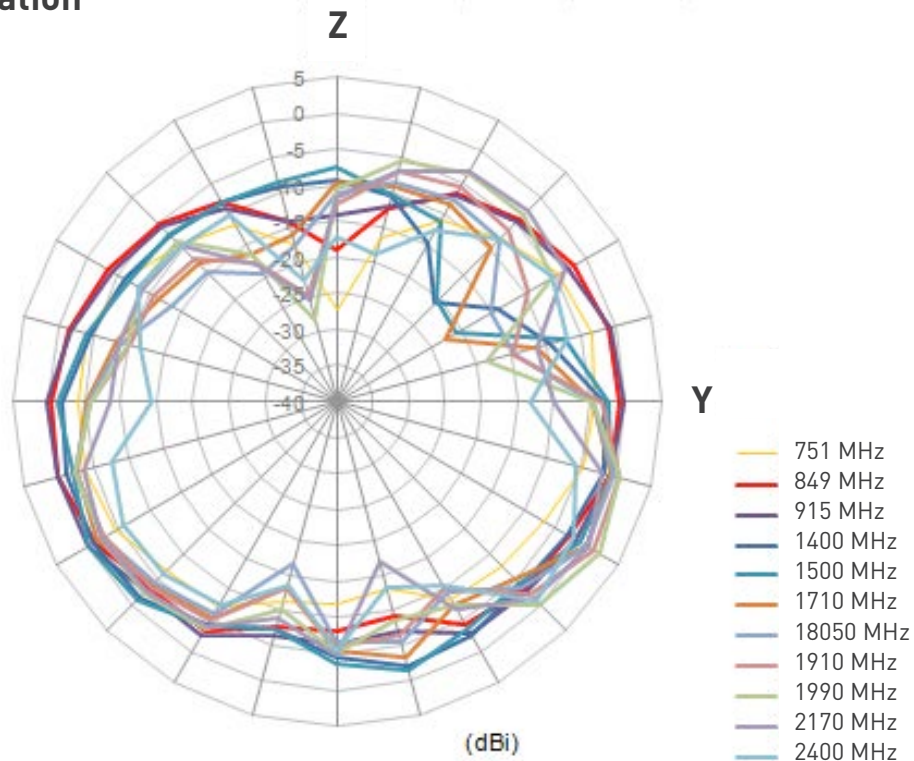

Figure 13. 2D Radiation Pattern of the PA700J Antenna..

3. Drawing



3D View

Bottom

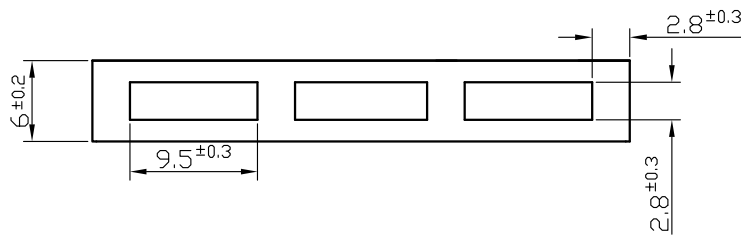

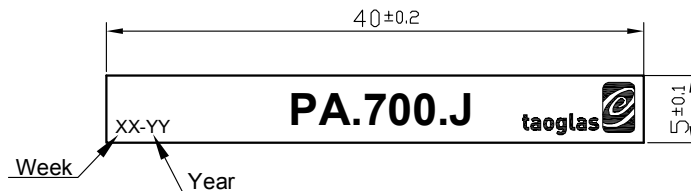

Top



Note:

Inductor Value 8.2nH for Taoglas Evaluation Board – different values may be required for different board designs

Note:

1. Week Batch Code
Example: 2012 Week 1=01.12
2. Copper Area 
3. Clearance Area 
4. Soldered Area 
5. Logo & Text Ink Printing : Black

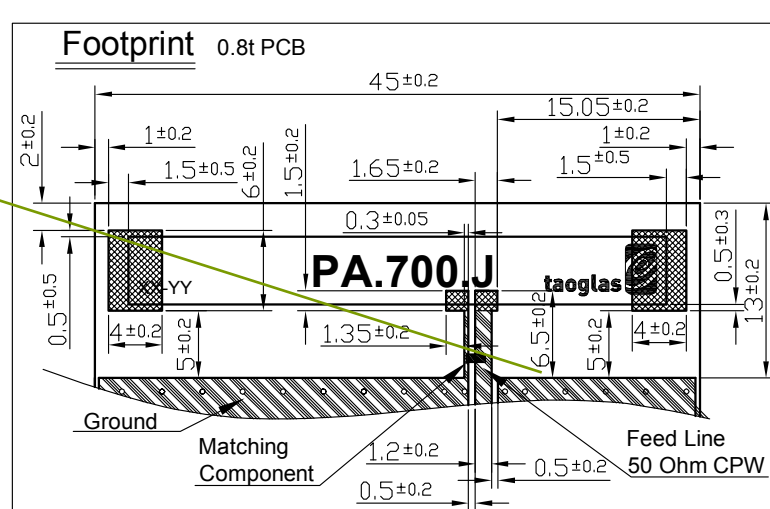

Figure 14. Mechanical Drawing of the PA700J Antenna.

5. Recommended Reflow Profile

The PA.700.J can be assembled following either Sn-Pb or Pb-Free assembly processes. The recommended soldering temperatures are as follows:

Phase	Profile Features	Sn-Pb Assembly	Pb-Free Assembly (SnAgCu)
Ramp-Up	Avg Ramp-Up Rate (T _{smax} to T _P)	3°C/second (max)	3°C/second (max)
Preheat	Temperature Min (T _{smin}) Temperature Max (T _{smax}) Time (t _{smin} to t _{smax})	100°C 150°C 60-120 seconds	100°C 150°C 60-120 seconds
Reflow	Temperature (T _L) Total Time Above T _L b(t _L)	183°C 60-150 seconds	217°C 60-150 seconds
Peak	Temperature (T _p) Time (t _p)	235°C 10-30 seconds	260°C 20-40 seconds
Ramp-Down	Rate	6°C/second (max)	6°C/second (max)
Time from 25°C to peak Temperature		6 minutes max	8 minutes max

Temperature profile - (green area) for the assembly process in reflow ovens

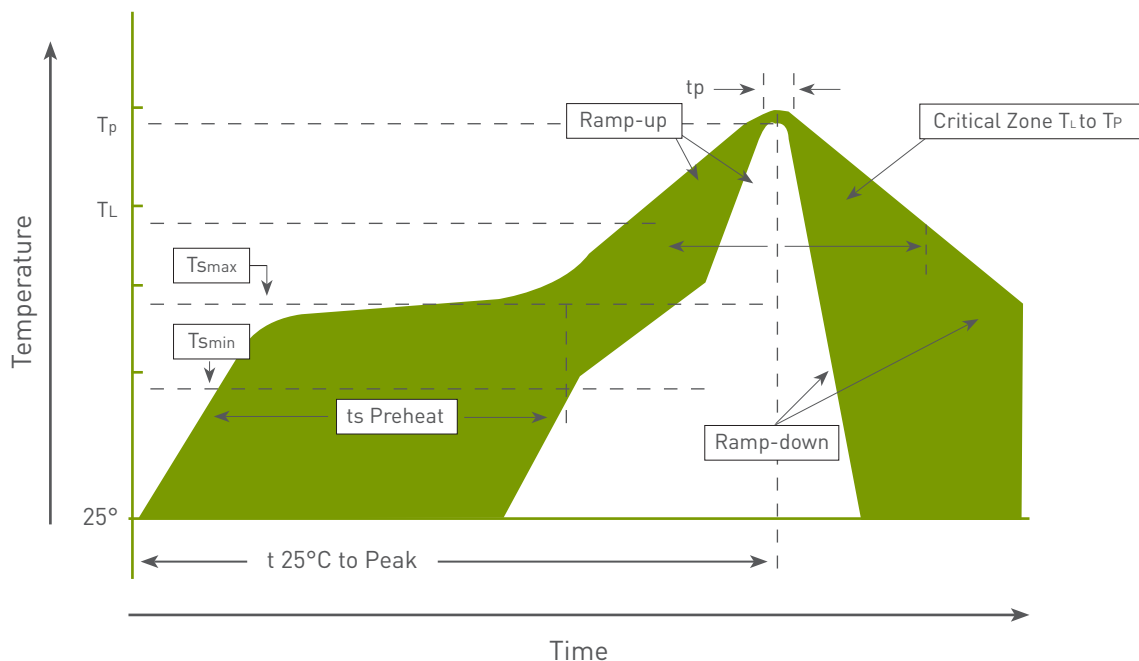
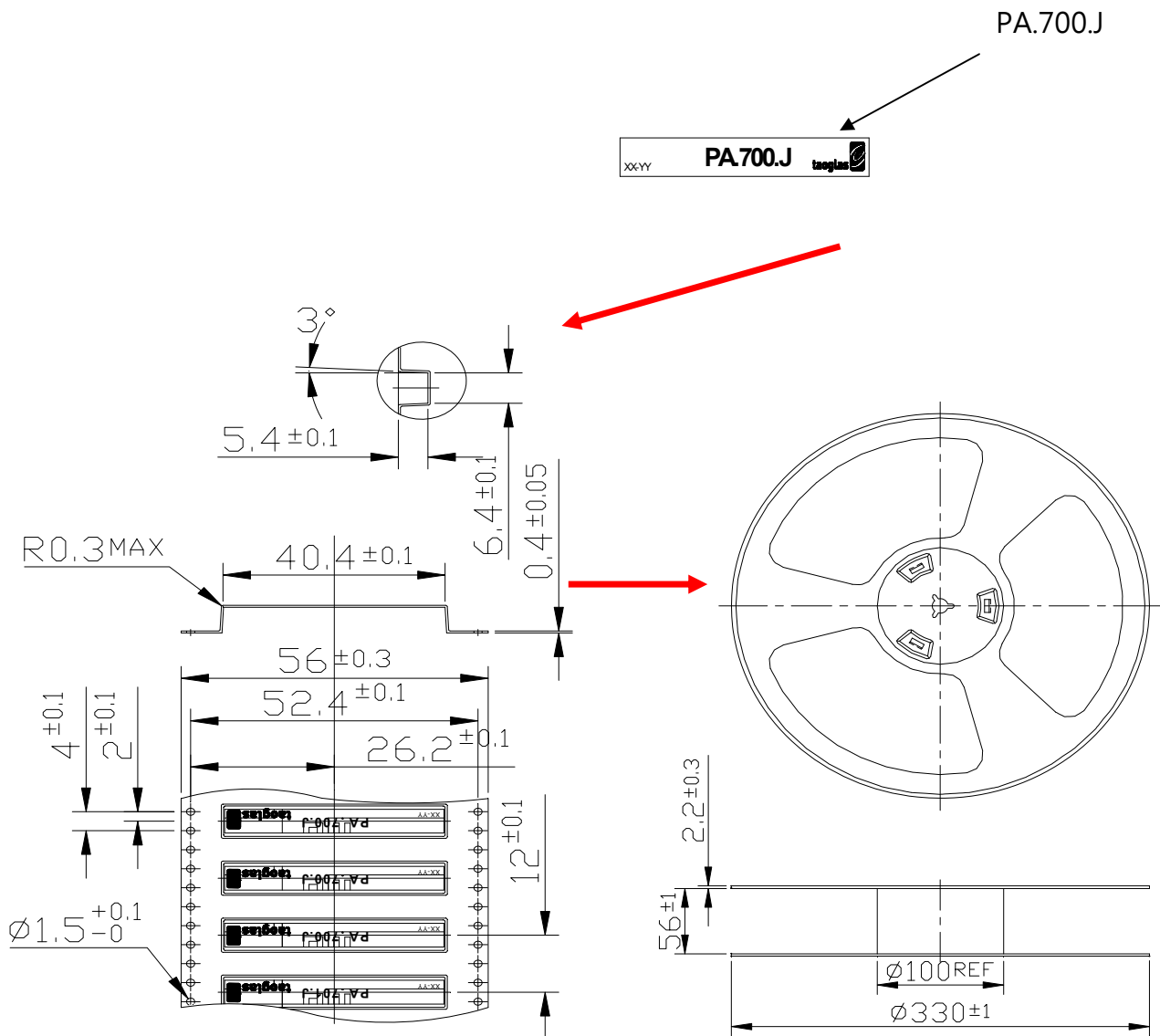

Figure 18. Temperature profile for the assembly process in reflow ovens

6. Packaging

Antenna par reel inside Total 450 PCS



Taoglas makes no warranties based on the accuracy or completeness of the contents of this document and reserves the right to make changes to specifications and

product descriptions at any time without notice. Taoglas reserves all rights to this document and the information contained herein.

Reproduction, use or disclosure to third parties without express permission is strictly prohibited.
Copyright © Taoglas Ltd.