

## DIP Power Inductors

# MBPL Series

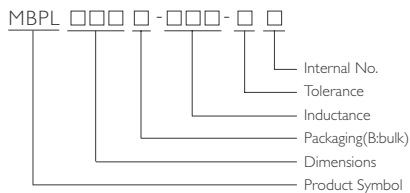

### PRODUCT IDENTIFICATION



### SHAPE AND DIMENSIONS

#### MBPL1319

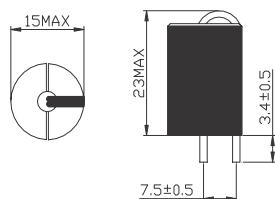

#### MBPL1220

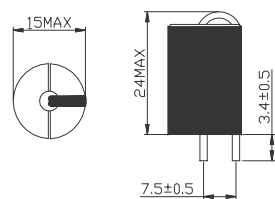

#### MBPL1217

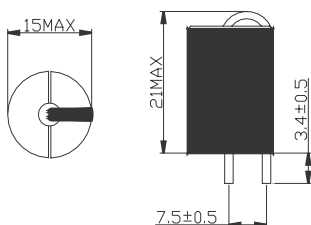

Dimensions : mm

### Features

- Magnetic shielded construction for high density board assembly
- High performance excellent DC current characteristics
- Large energy storage capacity
- Up to 40 amps continuous
- Custom designs available

### ELECTRICAL CHARACTERISTICS MBPL SERIES

PART NO.	INDUCTANCE at (μH)	TOLERANCE (±%)	TEST FREQUENCY (KHZ)	SER (KHZ) MIN.	DC RESISTANCE (mΩ)MAX	RATED CURRENT (A)MIN
MBPL1319B-R30M-S	0.30	20%	100		0.5	60
MBPL1319B-R60M-S	0.60	20%	100		1.0	60
MBPL1319B-R90M-S	0.90	20%	100		1.0	40
MBPL1319B-1R2M-S	1.20	20%	100		1.0	35
MBPL1220B-1R2M-S	1.20	20%	100		1.8	30
MBPL1220B-1R5M-S	1.50	20%	100		1.8	40
MBPL1217B-R30M-S	0.30	20%	100		0.7	45
MBPL1217B-R60M-S	0.60	20%	100		1.5	40
MBPL1217B-R90M-S	0.90	20%	100		1.5	30

Note: \* at 25MHZ \*\* at 7.9MHZ

When ordering please specify tolerance and packaging code.

Ex : PMC129- R60M-S Tolerance: M±20%, L± 15%, K± 10% Packaging: Clear Tape and Reel (Standard)

L Q :HP4287A SRF :HP8753D/E4991A RDC: Digital Multimeter SC-7401

Operating Temperature °C Range -40°C to +125°C



## TAPE DIMENSIONS

Dimensions : mm

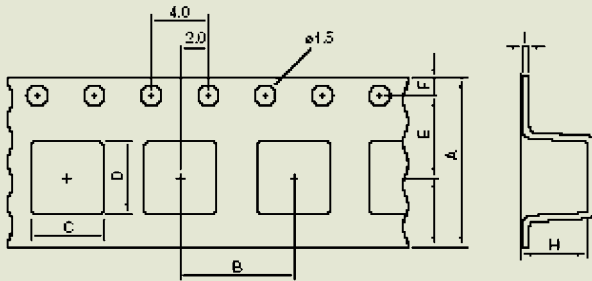

## TAPE MATERIAL

Carrier Tape : Polystyrene

Cover Type : Polyethylene

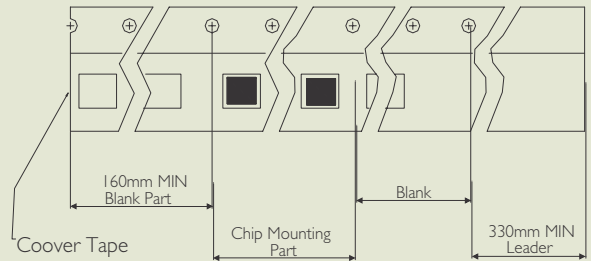

## REEL DIMENSIONS

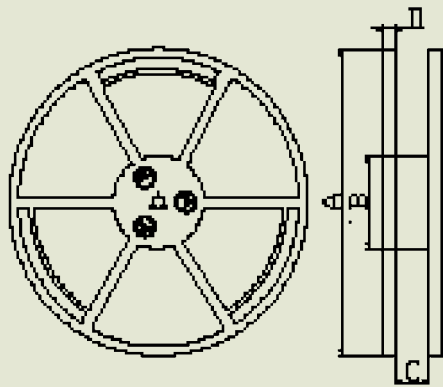

## RECOMMENDED PATTERN

Land Pattern

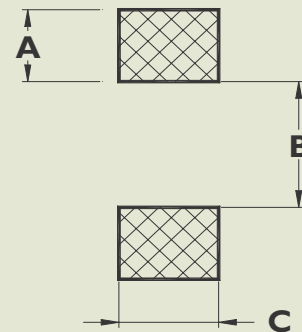

Dimensions : mm

TYPE	TAPE DIMENSIONS						REEL DIMENSIONS			RECOMMENDED PATTERN			QUANTITY /REEL
	A	B	C	D	E	H	A	B	C	A	B	C	
PMCI29	32	20	13.9	13.9	14.2	11.5	330	100	32.5	4	6	6.2	250
PMCI27	32	20	13.9	13.9	14.2	9	330	100	32.5	4	6	6.2	250
PMCI25	32	20	13.9	13.9	14.2	7	330	100	32.5	4	6	6.2	300



## PMC SERIES RELIABILITY TEST

### I-1 MECHANICAL PERFORMANCE

NO.	ITEM	SPECIFICATION	TEST CONDITIONS
I-1-1	Vibration	Appearance :No Damage L Change :within±10% Q Change :within±30% RDC:within Specificadion	Test device shall solderd on the substrate Oscillation frequency:10 to 50 to 10HZ for IMin Amplitude : 1.5mm Time :2Hrs,for each Axis (X,Y&Z),Total 6Hrs
I-1-2	Resistance to Soldering Heat	Appearance :No Damage	Pre-heating: 150°C , IMin. Solder Composition: Sn/Pb=63/37 Solder Temperature: 260±5°C Immersion Time: 10± ISec.
I-1-3	Solderability	The electrodes shall be at least 90% covered with new solder coating.	Pre-heating: 150°C , IMin. Solder Composition: Sn/Pb=63/37 Solder Temperature: 230±5°C Immersion Time: 4± ISec.

### I-2 ENVIRONMENTAL PERFORMANCE

NO	ITEM	SPECIFICATION	TEST CONDITIONS															
I-2-1	Temperature Shock	Appearance: No Damage L Change: within ± 10% L Change: within ± 30% RDC: within Speciflcation	10 Cycles (Air to Air) 1 Cycles shall Consist of: 30Min.Exposure to -55°C 30Min.Exposure to -125°C 15Sec.Max.Transition between Temperatures Measured after Exposure in the Room Condition for 24Hrs.															
I-2-2	Temperature Cycle		One Cycle <table border="1"> <thead> <tr> <th>Step</th> <th>Temperature(°C)</th> <th>Time (Min.)</th> </tr> </thead> <tbody> <tr> <td>1</td> <td>-25±3</td> <td>30</td> </tr> <tr> <td>2</td> <td>25±2</td> <td>3</td> </tr> <tr> <td>3</td> <td>85±3</td> <td>30</td> </tr> <tr> <td>4</td> <td>25±2</td> <td>3</td> </tr> </tbody> </table> Total: 100Cycles Measured after Exposure in the Room Condition for 24Hrs.	Step	Temperature(°C)	Time (Min.)	1	-25±3	30	2	25±2	3	3	85±3	30	4	25±2	3
Step	Temperature(°C)	Time (Min.)																
1	-25±3	30																
2	25±2	3																
3	85±3	30																
4	25±2	3																
I-2-3	Humidity Resistance		Temperature: 40±2°C Relative Humidity: 90~95% Time: 1000Hrs. Measured after Exposure in the Room Condition for 24Hrs.															
I-2-4	High Temperature Resistance		Temperature: 85±3°C Relative Humidity: 20% Applied Current: Rated Current Time: 1000Hrs. Measured after Exposure in the Room Condition for 24Hrs.															
I-2-5	Low Temperature Resistance		Temperature: -25±3°C Relative Humidity: 0% Time: 1000Hrs. Measured after Exposure in the Room Condition for 24Hrs.															