

Process Indicator K3HB-X

CSM_K3HB-X_DS_E_6_1

A Process Indicator Ideal for Discriminating and Displaying Measurements for Voltage/Current Signals

- Easy recognition of judgement results using color display that can be switched between red and green.
- Equipped with a position meter for monitoring operating status trends.
- External event input allows use in various measurement and discrimination applications.
- Series expanded to include DeviceNet models.
- Short body with depth of only 95 mm (from behind the front panel), or 97 mm for DeviceNet models.
- UL certification approval (Certification Mark License).
- CE Marking conformance by third party assessment body.
- Water-resistant enclosure conforms to NEMA 4X (equivalent to IP66).
- Capable of high-speed sampling at 50 times per second (20 ms)
- Easy-to-set two-point scaling allows conversion and display of any user-set values.

 Refer to *Safety Precautions for All Digital Panel Meters*.



Model Number Structure

Model Number Legend

Base Units and Optional Boards can be ordered individually or as sets.

Base Units

K3HB-X
1 5

1. Input Sensor Code

- VD: DC voltage input
- AD: DC current input
- VA: AC voltage input
- AA: AC current input

5. Supply Voltage

- 100-240 VAC: 100 to 240 VAC
- 24 VAC/VDC: 24 VAC/VDC

Optional Board

Sensor Power Supply/Output Boards

K33-
2

Relay/Transistor Output Boards

K34-
3

Event Input Boards

K35-
4

Note: 1. CPA can be combined with relay outputs only.

2. Only one of the following can be used by each Digital Indicator: RS-232C/RS-485 communications, a linear output, or DeviceNet communications.

Accessories (Sold Separately)

- K32-DICN: Special Cable (for event inputs, with 8-pin connector)
- K32-BCD: Special BCD Output Cable

Base Units with Optional Boards

K3HB-X -
1 2 3 4 5

2. Sensor Power Supply/Output Type Code

- None: None
- CPA: Relay output (PASS: SPDT) + Sensor power supply (12 VDC +/-10%, 80 mA) (See note 1.)
- L1A: Linear current output (0 to 20 or 4 to 20 mA DC) + Sensor power supply (12 VDC +/-10%, 80 mA) (See note 2.)
- L2A: Linear voltage output (0 to 5, 1 to 5, or 0 to 10 VDC) + Sensor power supply (12 VDC +/-10%, 80 mA) (See note 2.)
- A: Sensor power supply (12 VDC +/-10%, 80 mA)
- FLK1A: Communications (RS-232C) + Sensor power supply (12 VDC +/-10%, 80 mA) (See note 2.)
- FLK3A: Communications (RS-485) + Sensor power supply (12 VDC +/-10%, 80 mA) (See note 2.)

3. Relay/Transistor Output Type Code

- None: None
- C1: Relay contact (H/L: SPDT each)
- C2: Relay contact (HH/H/LL/L: SPST-NO each)
- T1: Transistor (NPN open collector: HH/H/PASS/L/LL)
- T2: Transistor (PNP open collector: HH/H/PASS/L/LL)
- BCD*: BCD output + transistor output (NPN open collector: HH/H/PASS/L/LL)
- DRT: DeviceNet (See note 2.)
- * A Special BCD Output Cable (sold separately) is required.

4. Event input Type Code

- None: None
- 1: 5 inputs (M3 terminal blocks), NPN open collector
- 2: 8 inputs (10-pin MIL connector), NPN open collector
- 3: 5 inputs (M3 terminal blocks), PNP open collector
- 4: 8 inputs (10-pin MIL connector), PNP open collector

Rubber Packing

Model
K32-P1

Note: Rubber packing is provided with the Controller.

Specifications

■ Ratings

Power supply voltage	100 to 240 VAC (50/60 Hz), 24 VAC/VDC, DeviceNet power supply: 24 VDC	
Allowable power supply voltage range	85% to 110% of the rated power supply voltage, DeviceNet power supply: 11 to 25 VDC	
Power consumption (See note 1.)	100 to 240 V: 18 VA max. (max. load) 24 VAC/DC: 11 VA/7 W max. (max. load)	
Current consumption	DeviceNet power supply: 50 mA max. (24 VDC)	
Input	DC voltage, DC current, AC voltage, AC current	
A/D conversion method	Delta-Sigma method	
External power supply	12 VDC \pm 10%, 80 mA (models with external power supply only)	
Event inputs (See note 2.)	Timing input	NPN open collector or no-voltage contact signal ON residual voltage: 3 V max. ON current at 0 Ω : 17 mA max. Max. applied voltage: 30 VDC max. OFF leakage current: 1.5 mA max.
	Startup compensation timer input	NPN open collector or no-voltage contact signal ON residual voltage: 2 V max. ON current at 0 Ω : 4 mA max.
	Hold input	Max. applied voltage: 30 VDC max.
	Reset input	OFF leakage current: 0.1 mA max.
	Forced-zero input	
Output ratings (depends on the model)	Relay output	250 VAC, 30 VDC, 5 A (resistive load) Mechanical life expectancy: 5,000,000 operations, Electrical life expectancy: 100,000 operations
	Transistor output	Maximum load voltage: 24 VDC, Maximum load current: 50 mA, Leakage current: 100 μ A max.
	Linear output	Linear output 0 to 20 mA DC, 4 to 20 mA DC: Load: 500 Ω max, Resolution: Approx. 10,000, Output error: \pm 0.5% FS Linear output 0 to 5 VDC, 1 to 5 VDC, 0 to 10 VDC: Load: 5 k Ω max, Resolution: Approx. 10,000, Output error: \pm 0.5% FS (1 V or less: \pm 0.15 V; no output for 0 V or less)
Display method	Negative LCD (backlit LED) display 7-segment digital display (Character height: PV: 14.2 mm (green/red); SV: 4.9 mm (green))	
Main functions	Scaling function, measurement operation selection, averaging, previous average value comparison, forced-zero, zero-limit, output hysteresis, output OFF delay, output test, teaching, display value selection, display color selection, key protection, bank selection, display refresh period, maximum/minimum hold, reset	
Ambient operating temperature	-10 to 55°C (with no icing or condensation)	
Ambient operating humidity	25% to 85%	
Storage temperature	-25 to 65°C (with no icing or condensation)	
Altitude	2,000 m max.	
Accessories	Watertight packing, 2 fixtures, terminal cover, unit stickers, instruction manual. DeviceNet models also include a DeviceNet connector (Hirose HR31-5.08P-5SC(01)) and crimp terminals (Hirose HR31-SC-121) (See note 3.)	

- Note:**
- DC power supply models require a control power supply capacity of approximately 1 A per Unit when power is turned ON. Particular attention is required when using two or more DC power supply models. The OMRON S8VS-series DC Power Supply Unit is recommended.
 - PNP input types are also available.
 - For K3HB-series DeviceNet models, use only the DeviceNet Connector included with the product. The crimp terminals provided are for Thin Cables.

■ Characteristics

Display range	-19,999 to 99,999	
Sampling period	20 ms (50 times/second)	
Comparative output response time	DC input: 100 ms max.; AC input: 300 ms max. (The time until the comparative output is output when there is a forced sudden change in the input signal from 15% to 95% or 95% to 15%.)	
Linear output response time	DC input: 150 ms max.; AC input: 420 ms max. (The time until the final analog output value is reached when there is a forced sudden change in the output signal from 15% to 95% or 95% to 15%.)	
Insulation resistance	20 MΩ min. (at 500 VDC)	
Dielectric strength	2,300 VAC for 1 min between external terminals and case	
Noise immunity	100 to 240 VAC models: ±1,500 V at power supply terminals in normal or common mode (waveform with 1-ns rising edge and pulse width of 1 μs/100 ns) 24 VAC/VDC models: ±1,500 V at power supply terminals in normal or common mode (waveform with 1-ns rising edge and pulse width of 1 μs/100 ns)	
Vibration resistance	Frequency: 10 to 55 Hz; Acceleration: 50 m/s ² , 10 sweeps of 5 min each in X, Y, and Z directions	
Shock resistance	150 m/s ² (100 m/s ² for relay outputs) 3 times each in 3 axes, 6 directions	
Weight	Approx. 300 g (Base Unit only)	
Degree of protection	Front panel	Conforms to NEMA 4X for indoor use (equivalent to IP66)
	Rear case	IP20
	Terminals	IP00 + finger protection (VDE0106/100)
Memory protection	EEPROM (non-volatile memory) Number of rewrites: 100,000	
Applicable standards	UL61010-1, CSA C22.2 No. 1010.1 (evaluated by UL) EN61010-1 (IEC61010-1): Pollution degree 2/Overvoltage category II EN61326: 1997, A1: 1998, A2: 2001	
EMC	EMI: EN61326 industrial applications Electromagnetic radiation interference CISPR 11 Group 1, Class A Terminal interference voltage CISPR 11 Group 1, Class A EMS: EN61326 industrial applications Electrostatic Discharge Immunity EN61000-4-2: 4 kV (contact), 8 kV (in air) Radiated Electromagnetic Field Immunity EN61000-4-3: 10 V/m 1 kHz sine wave amplitude modulation (80 MHz to 1 GHz, 1.4 to 2 GHz) Electrical Fast Transient/Burst Immunity EN61000-4-4: 2 kV (power line), 1 kV (I/O signal line) Surge Immunity EN61000-4-5: 1 kV with line (power line), 2 kV with ground (power line) Conducted Disturbance Immunity EN61000-4-6: 3 V (0.15 to 80 MHz) Power Frequency Magnetic Immunity EN61000-4-8: 30 A/m (50 Hz) continuous time Voltage Dips and Interruptions Immunity EN61000-4-11: 0.5 cycle, 0°/180°, 100% (rated voltage)	

■ Input Range (Measurement Range and Accuracy) CAT II

Input type	Range	Set value	Measurement range	Input impedance	Accuracy	Allowable instantaneous overload (30 s)
K3HB-XVD DC voltage	A	R_{ud}	± 199.99 V	10 M Ω min.	$\pm 0.1\%$ rdg ± 1 digit max.	± 400 V
	B	b_{ud}	± 19.999 V	1 M Ω min.		± 200 V
	C	c_{ud}	± 1.9999 V			
	D	d_{ud}	1.0000 to 5.0000 V			
K3HB-XAD DC current	A	R_{Rd}	± 199.99 mA	1 Ω max.	$\pm 0.1\%$ rdg ± 1 digit max.	± 400 mA
	B	b_{Rd}	± 19.999 mA	10 Ω max.		± 200 mA
	C	c_{Rd}	± 1.9999 mA	33 Ω max.		
	D	d_{Rd}	4.000 to 20.000 mA	10 Ω max.		
K3HB-XVA AC voltage (See note 4.)	A	R_{uR}	0.0 to 400.0 V	1 M Ω min.	$\pm 0.3\%$ rdg ± 5 digits max.	700 V
	B	b_{uR}	0.00 to 199.99 V			
	C	c_{uR}	0.000 to 19.999 V		$\pm 0.5\%$ rdg ± 10 digits max.	400 V
	D	d_{uR}	0.0000 to 1.9999 V			
K3HB-XAA AC current	A	R_{RR}	0.000 to 10.000 A	(0.5 VA CT) (See note 3.)	$\pm 0.5\%$ rdg ± 20 digits max.	20 A
	B	b_{RR}	0.0000 to 1.9999 A	(0.5 VA CT) (See note 3.)		
	C	c_{RR}	0.00 to 199.99 mA	1 Ω max.	$\pm 0.5\%$ rdg ± 10 digits max.	2 A
	D	d_{RR}	0.000 to 19.999 mA	10 Ω max.		

Note: 1. The accuracy is for an input frequency range of 40 Hz to 1 kHz (except for AD current input A and B ranges of 50 to 60 Hz) and an ambient temperature of $23 \pm 5^\circ\text{C}$. The error, however, increases below 10% of the maximum input value.

DC voltage input (all ranges): 10% or less of max. input = $\pm 0.15\%$ FS

DC current input (all ranges): 10% or less of max. input = $\pm 0.1\%$ FS

AC voltage input (A: 0.0 to 400.0 V): 10% or less of max. input = $\pm 0.15\%$ FS

AC voltage input (B: 0.00 to 199.99 V): 10% or less of max. input = $\pm 0.2\%$ FS

AC voltage input (C: 0.000 to 19.999 V; D: 0.0000 to 1.9999 V): 10% or less of max. input = $\pm 1.0\%$ FS

AC current input (A: 0.000 to 10.000 A): 10% or less of max. input = $\pm 0.25\%$ FS

AC current input (B: 0.0000 to 1.9999 A): 10% or less of max. input = $\pm 0.5\%$ FS

AC current input (C: 0.00 to 199.99 mA; D: 0.000 to 19.999 A): 10% or less of max. input = $\pm 0.15\%$ FS

When DC voltage input models are used with a ± 1.9999 V range, make sure that the connections between input terminals are not open. If the input terminals are open, the display will show large variations. Connect resistance of approximately 1 M Ω between the input terminals if they are open.

2. The letters "rdg" mean "reading" and refer to the input error.

3. The value (0.5 VA CT) is the VA consumption of the internal CT (current transformer).

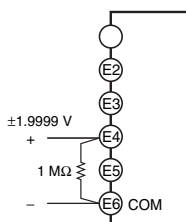

4. The K3HB-XVA□□ complies with UL standards when the applied input voltage is within the range 0 to 150 VAC.

If the input voltage is higher than 150 VAC, install an external transformer or take other measures to drop the voltage to 150 VAC or lower.

Common Specifications

■ Event Input Ratings

Input type	S-TMR, HOLD, RESET, ZERO, BANK1, BANK2, BANK4	TIMING
Contact	ON: 1 kΩ max., OFF: 100 kΩ min.	---
No-contact	ON residual voltage: 2 V max. OFF leakage current: 0.1 mA max. Load current: 4 mA max. Maximum applied voltage: 30 VDC max.	ON residual voltage: 3 V max. OFF leakage current: 1.5 mA max. Load current: 17 mA max. Maximum applied voltage: 30 VDC max.

■ Output Ratings

Contact Output

Item	Resistive loads (250 VAC, $\cos\phi=1$; 30 VDC, L/R=0 ms)	Inductive loads (250 VAC, closed circuit, $\cos\phi=0.4$; 30 VDC, L/R=7 ms)
Rated load	5 A at 250 VAC 5 A at 30 VDC	1 A at 250 VAC 1 A at 30 VDC
Mechanical life expectancy	5,000,000 operations	
Electrical life expectancy	100,000 operations	

Transistor Output

Maximum load voltage	24 VDC
Maximum load current	50 mA
Leakage current	100 μA max.

Linear Output

Item	0 to 20 mA	4 to 20 mA	0 to 5 V	1 to 5 V	0 to 10 V
Allowable load impedance	500 Ω max.		5 kΩ min.		
Resolution	Approx. 10,000				
Output error	±0.5%FS		±0.5%FS (1 V or less: ±0.15 V; no output for 0 V or less.)		

Serial Communications Output

Item	RS-232C, RS-485
Communications method	Half duplex
Synchronization method	Start-stop synchronization
Baud rate	9,600, 19,200, or 38,400 bps
Transmission code	ASCII
Data length	7 bits or 8 bits
Stop bit length	2 bits or 1 bit
Error detection	Vertical parity and FCS
Parity check	Odd, even

Note: For details on serial and DeviceNet communications, refer to the *Digital Indicator K3HB Communications User's Manual* (Cat.No. N129).

BCD Output I/O Ratings (Input Signal Logic: Negative)

I/O signal name		Item	Rating	
Inputs	REQUEST	Input signal	No-voltage contact input	
	HOLD	Input current for no-voltage input	10 mA	
	MAX	Signal level	ON voltage	1.5 V max.
	MIN		OFF voltage	3 V min.
RESET				
Outputs	DATA	Maximum load voltage	24 VDC	
	POLARITY	Maximum load current	10 mA	
	OVER	Leakage current	100 μA max.	
	DATA VALID			
	RUN			
	HH	Maximum load voltage	24 VDC	
	H	Maximum load current	50 mA	
PASS				
L				
LL	Leakage current	100 μA max.		

Note: For details on serial and DeviceNet communications, refer to the *Digital Indicator K3HB Communications User's Manual* (Cat.No. N129).

DeviceNet Communications

Communications protocol		Conforms to DeviceNet																
Supported communications	Remote I/O communications	Master-Slave connection (polling, bit-strobe, COS, cyclic) Conforms to DeviceNet communications standards.																
	I/O allocations	Allocate any I/O data using the Configurator. Allocate any data, such as DeviceNet-specific parameters and variable area for Digital Indicators. Input area: 2 blocks, 60 words max. Output area: 1 block, 29 words max. (The first word in the area is always allocated for the Output Execution Enabled Flags.)																
	Message communications	Explicit message communications CompoWay/F communications commands can be executed (using explicit message communications)																
Connection methods		Combination of multi-drop and T-branch connections (for trunk and drop lines)																
Baud rate		DeviceNet: 500, 250, or 125 Kbps (automatic follow-up)																
Communications media		Special 5-wire cable (2 signal lines, 2 power supply lines, 1 shield line)																
Communications distance		<table border="1"> <thead> <tr> <th>Baud rate</th> <th>Network length (max.)</th> <th>Drop line length (max.)</th> <th>Total drop line length (max.)</th> </tr> </thead> <tbody> <tr> <td>500 Kbps</td> <td>100 m (100 m)</td> <td>6 m</td> <td>39 m</td> </tr> <tr> <td>250 Kbps</td> <td>100 m (250 m)</td> <td>6 m</td> <td>78 m</td> </tr> <tr> <td>125 Kbps</td> <td>100 m (500 m)</td> <td>6 m</td> <td>156 m</td> </tr> </tbody> </table> <p>The values in parentheses are for Thick Cable.</p>	Baud rate	Network length (max.)	Drop line length (max.)	Total drop line length (max.)	500 Kbps	100 m (100 m)	6 m	39 m	250 Kbps	100 m (250 m)	6 m	78 m	125 Kbps	100 m (500 m)	6 m	156 m
Baud rate	Network length (max.)	Drop line length (max.)	Total drop line length (max.)															
500 Kbps	100 m (100 m)	6 m	39 m															
250 Kbps	100 m (250 m)	6 m	78 m															
125 Kbps	100 m (500 m)	6 m	156 m															
Communications power supply		24-VDC DeviceNet power supply																
Allowable voltage fluctuation range		11 to 25-VDC DeviceNet power supply																
Current consumption		50 mA max. (24 VDC)																
Maximum number of nodes		64 (DeviceNet Configurator is counted as one node when connected)																
Maximum number of slaves		63																
Error control checks		CRC errors																
DeviceNet power supply		Supplied from DeviceNet communications connector																

Internal Block Diagram

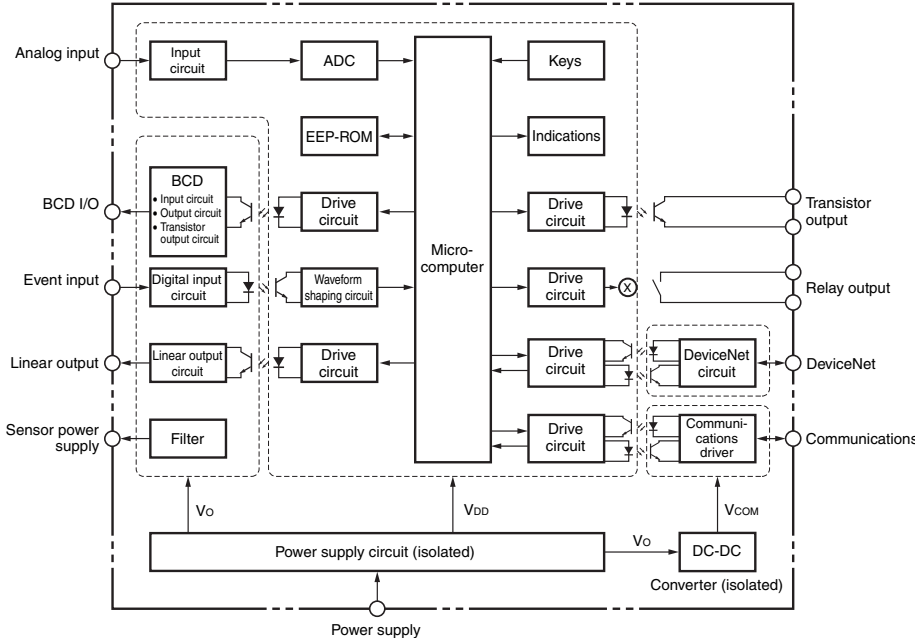

Power Supply Derating Curve for Sensor (Reference Value)

With 12 V

With 10 V

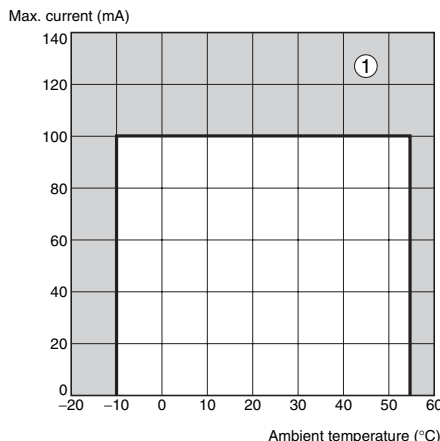
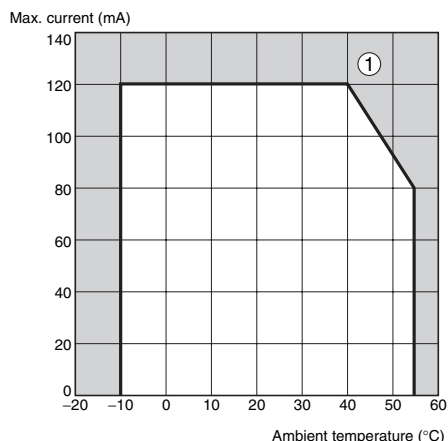

- Note:** 1. The above values are for standard mounting. The derating curve differs depending on the mounting conditions.
 2. Do not use the Sensor outside of the derating area (i.e., do not use it in the area labeled ① in the above graphics). Doing so may occasionally cause deterioration or damage to internal components.

Component Names and Functions

Max/Min status indicator

Turns ON when the maximum value or minimum value is displayed in the RUN level.

Level/bank display

In RUN level, displays the bank if the bank function is ON. (Turns OFF if the bank function is OFF.)
 In other levels, displays the current level.

Comparative output status indicators

Display the status of comparative outputs.

Status indicators

Display	Function
T-ZR	Turns ON when the tare zero function is executed. Turns OFF if it is not executed or is cleared.
Zero	Turns ON when the forced-zero function is executed. Turns OFF if it is not executed or is cleared. (Excluding the K3HB-H.)
Hold	Turns ON/OFF when hold input turns ON/OFF.

PV display

Displays PVs, maximum values, minimum values, parameter names, and error names.

Position meter

Displays the position of the PV with respect to a desired scale.

SV display

Displays SV and monitor values.

SV display status indicators

Display	Function
TG	Turns ON when the timing signal turns ON. Otherwise OFF.
T	Turns ON when parameters for which teaching can be performed are displayed.
HH, H, L, LL	In RUN level, turn ON when the comparative set values HH, H, L, and LL are displayed.

MAX/MIN Key

Used to switch the display between the PV, maximum value, and minimum value and to reset the maximum and minimum values.

LEVEL Key

Used to switch level.

MODE Key

Used to switch the parameters displayed.

SHIFT Key

Used to change parameter settings. When changing a set value, this key is used to move along the digits.

UP Key

When changing a set value, this key is used to change the actual value. When a measurement value is displayed, this key is used to execute or clear the forced-zero function or to execute teaching.

BCD Output Timing Chart

A REQUEST signal from a Programmable Controller or other external device is required to read BCD data.

Single Sampling Data Output

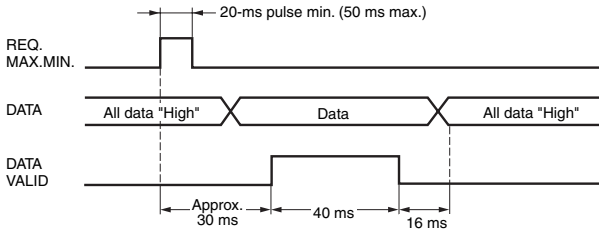

The data is set in approximately 30 ms from the rising edge of the REQUEST signal and the DATA VALID signal is output. When reading the data from a Programmable Controller, start reading the data when the DATA VALID signal turns ON. The DATA VALID signal will turn OFF 40 ms later, and the data will turn OFF 16 ms after that.

Continuous Data Output

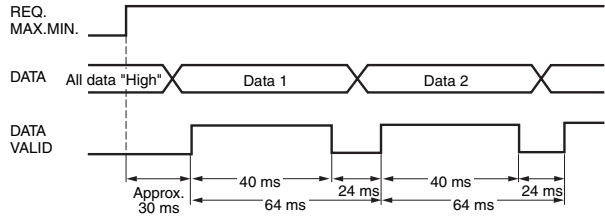

Measurement data is output every 64 ms while the REQUEST signal remains ON.

Note: If HOLD is executed when switching between data 1 and data 2, either data 1 or data 2 is output depending on the timing of the hold signal. The data will not go LOW.

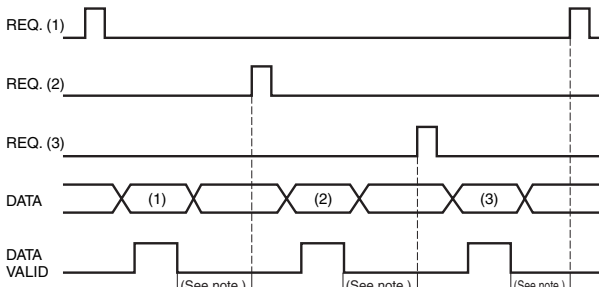
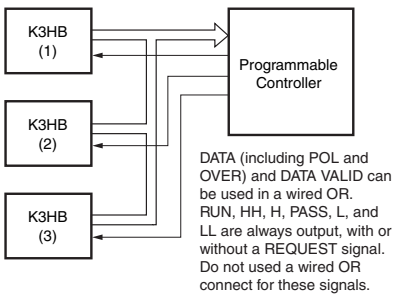

Note: Leave 20 ms min. between DATA VALID turning OFF and the REQUEST signal.

Programmable Controller Connection Example

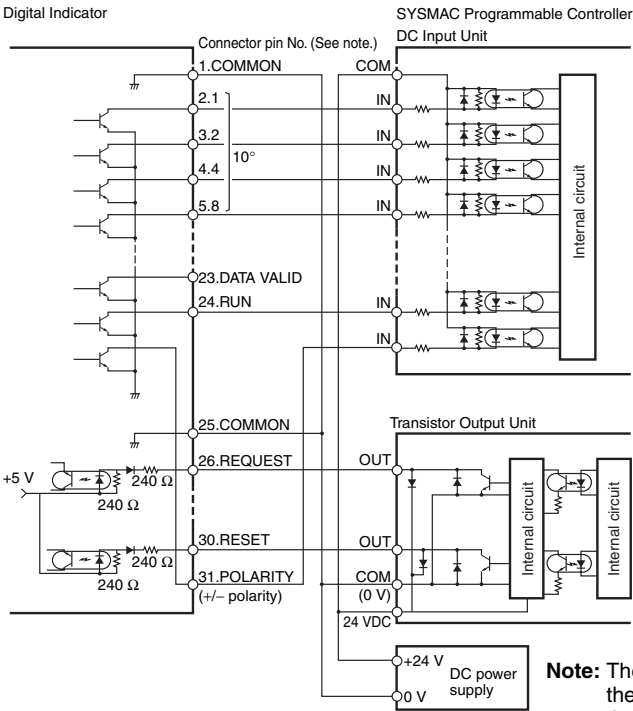

Display Unit Connection Example

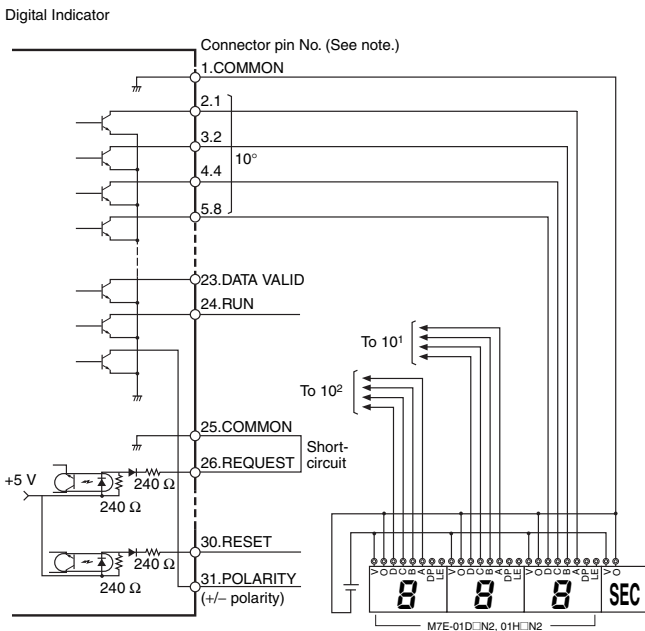

Note: The BCD output connector pin number is the D-sub connector pin number when the BCD Output Cable (sold separately) is connected. This number differs from the pin number for the Digital Indicator narrow pitch connector (manufactured by Honda Tsushin Kogyo Co., Ltd.).

Refer to the following User's Manual for application precautions and other information required when using the Digital Indicator:
 K3HB-S/-X/-V/-H Digital Indicator User's Manual (Cat. No. N128)
 The manual can be downloaded from the following site in PDF format: OMRON Industrial Web <http://www.fa.omron.co.jp>

Connections

Terminal Arrangement

Note: Insulation is used between signal input, event input, output, and power supply terminals.

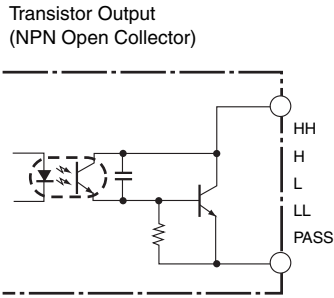
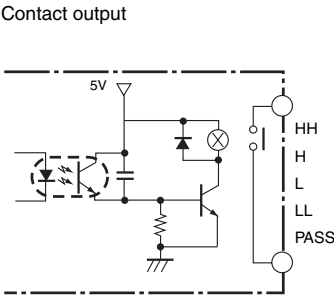
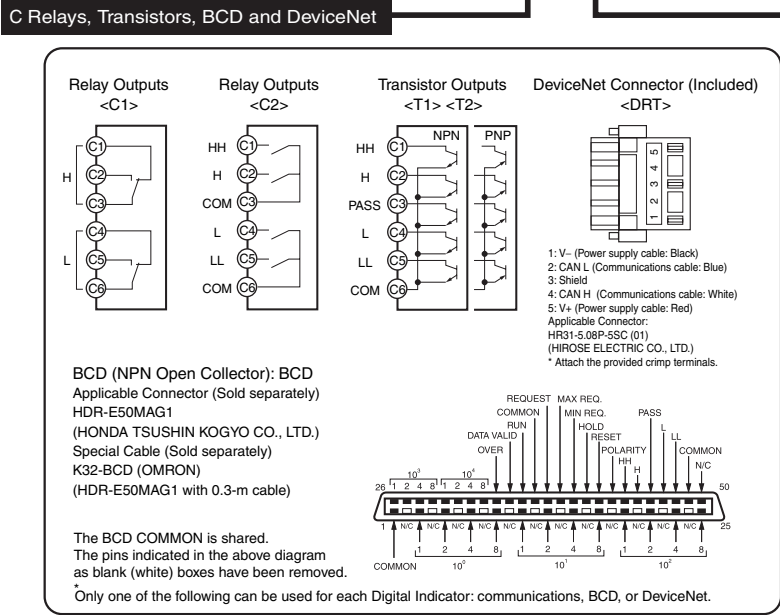
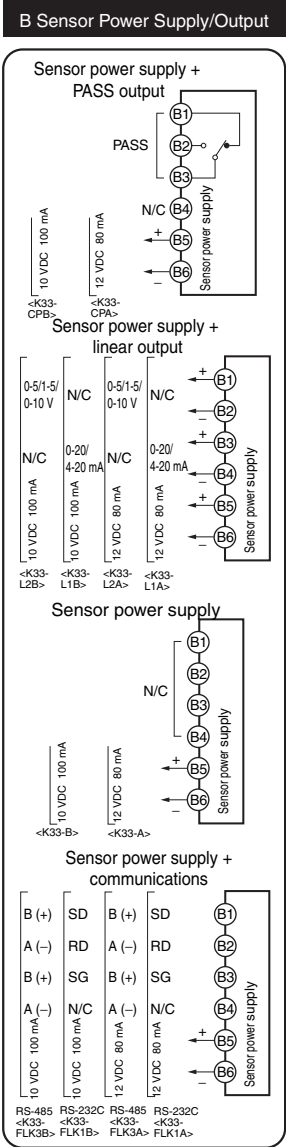
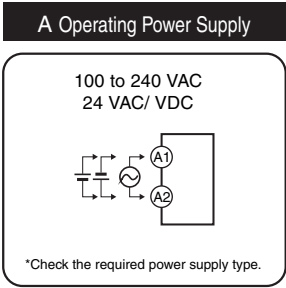
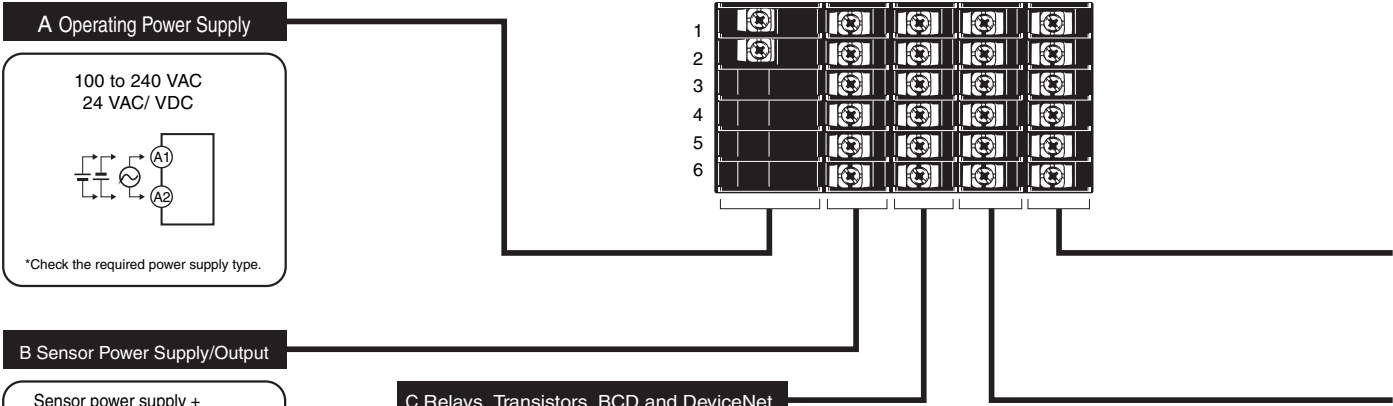

Safety Standards Conformance

- Always use a EN/IEC-compliant power supply with reinforced insulation or double insulation for the DeviceNet power supply.
- The product must be used indoors for the above applicable standards to apply.
- The K3HB-XVA□□ complies with UL standards when the applied input voltage is within the range 0 to 150 VAC.

E Analog Input

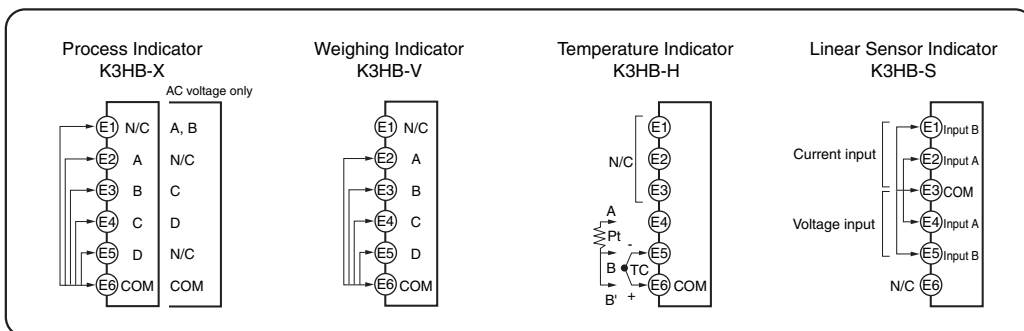

D Event Input

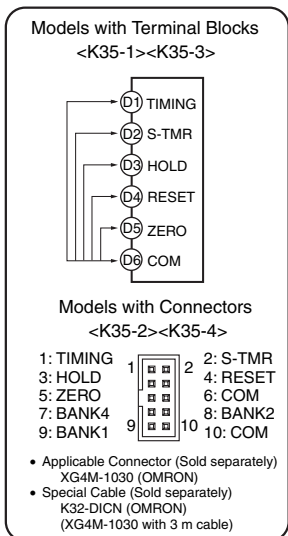

- Use terminal pin D6 as the common terminal.
- Use NPN open collector or no-voltage contacts for event input. PNP types are also available.

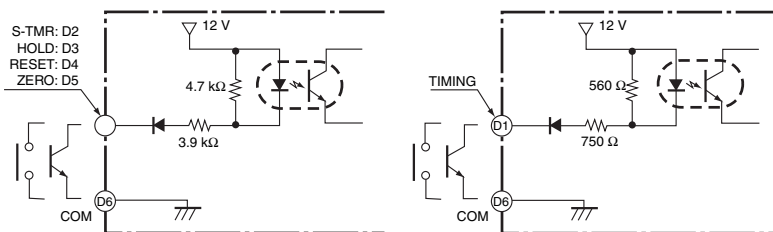

BCD Output Cable

Model	Shape	Pin arrangement
K32-BCD	<p>Cover: HDR-E50LPA5 (manufactured by Honda Tsushin Co., Ltd.) Connector: HDR-E50MAG1 (manufactured by Honda Tsushin Co., Ltd.)</p> <p>D-sub connector (37-pin female) Cover: 17JE-37H-1A (manufactured by DDK) Connector: Equivalent to 17JE-13370-02 (manufactured by DDK) Stand: 17L-002A (manufactured by DDK)</p>	<p>COMMON → 1, 2, 4, 8, 10¹, 10², 10³, 10⁴</p> <p>4 10⁴</p> <p>OVER DATA VALID RUN COMMON REQUEST MAX REQ. MIN REQ. HOLD RESET POLARITY HH H PASS L LL COMMON</p>

Note: The BCD Output Cable has a D-sub plug. Cover: 17JE-37H-1A (manufactured by DDK); Connector: equivalent to 17JE-23370-02 (D1) (manufactured by DDK)

Special Cable (for Event Inputs with 8-pin Connector)

Model	Appearance	Wiring																						
K32-DICN	<p>Cable marking (3 m)</p>	<table border="1"> <thead> <tr> <th>Pin No.</th> <th>Signal name</th> </tr> </thead> <tbody> <tr><td>1</td><td>N/C</td></tr> <tr><td>2</td><td>S-TMR</td></tr> <tr><td>3</td><td>HOLD</td></tr> <tr><td>4</td><td>RESET</td></tr> <tr><td>5</td><td>N/C</td></tr> <tr><td>6</td><td>COM</td></tr> <tr><td>7</td><td>BANK4</td></tr> <tr><td>8</td><td>BANK2</td></tr> <tr><td>9</td><td>BANK1</td></tr> <tr><td>10</td><td>COM</td></tr> </tbody> </table>	Pin No.	Signal name	1	N/C	2	S-TMR	3	HOLD	4	RESET	5	N/C	6	COM	7	BANK4	8	BANK2	9	BANK1	10	COM
Pin No.	Signal name																							
1	N/C																							
2	S-TMR																							
3	HOLD																							
4	RESET																							
5	N/C																							
6	COM																							
7	BANK4																							
8	BANK2																							
9	BANK1																							
10	COM																							

Main Functions

Measurement

Timing Hold

Normal

- Continuously performs measurement and always outputs based on comparative results.

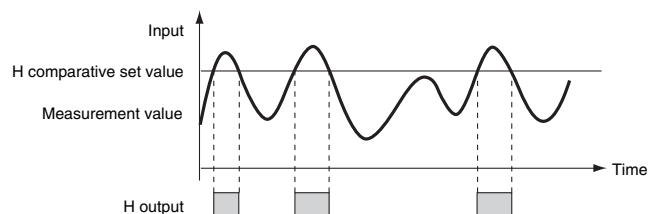

Peak Hold/Bottom Hold

- Measures the maximum (or minimum) value in a specified period.

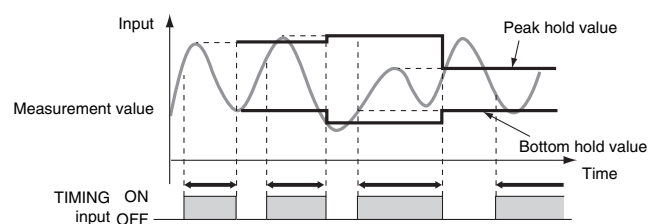

Scaling

Scaling converts input signals in any way required before displaying them. The values can be manipulated by shifting, inverting, or +/- reversing.

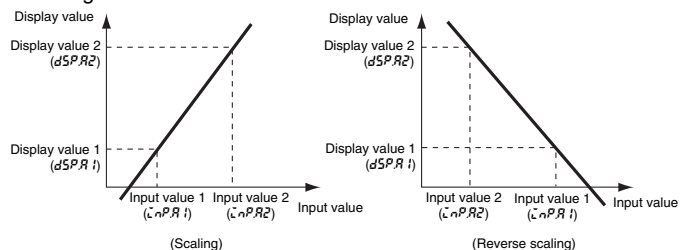

Teaching

Settings for scaling can be made using the present measurement values instead of inputting values with the SHIFT and UP Keys. This is a convenient function for making the settings while monitoring the operating status.

Standby Sequence

Turns the comparative output OFF until the measurement value enters the PASS range.

Sampling Hold

- Holds the measurement at the rising edge of the TIMING signal.

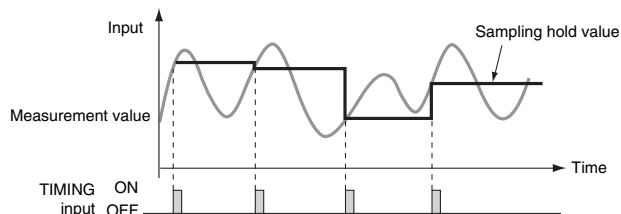

Peak-to-peak Hold

- Measures the difference between the maximum and minimum values in a specified period.

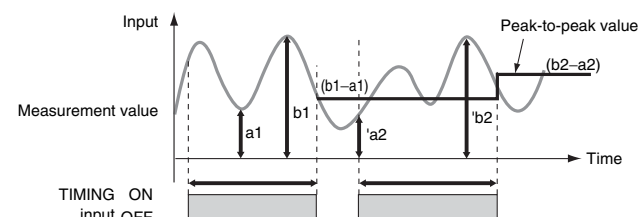

Average Processing

Average processing of input signals with extreme changes or noise smooths out the display and makes control stable.

Previous Average Value Comparison

Slight changes can be removed from input signals to detect only extreme changes.

Input Compensation/Display

Forced-zero

Forces the present value to 0. (Convenient for setting reference values or deducting tares for weight measurement.)

Zero-trimming

Compensates for mild fluctuations in input signals due to factors such as sensor temperature drift, based on OK (PASS) data at measurement. (This function can be used with sampling hold, peak hold, or bottom hold.)

Zero-limit

Changes the display value to 0 for input values less than the set value. It is enabled in normal mode only. (This function can be used, for example, to stop negative values being displayed or to eliminate flickering and minor inconsistencies near 0.)

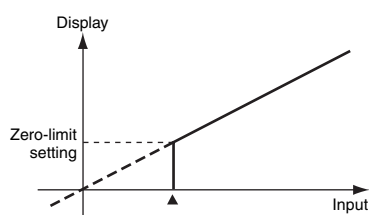

Display Refresh Period

The display refresh period can be lengthened to reduce flickering and thereby make the display easier to read.

Display Color Selection

Values can be displayed in either red or green. With comparative output models, the display color can also be set to change according to the status of comparative outputs (e.g., green to red or red to green).

Example) Setting: *Green*

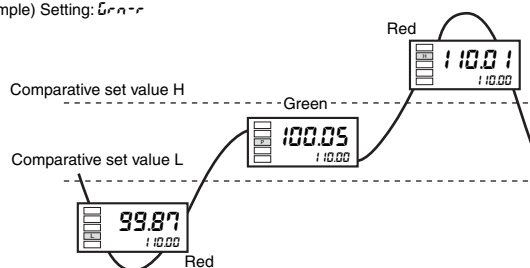

Display Value Selection

The current display value can be selected from the present value, the maximum value, and the minimum value.

Step Value

It is possible to specify (i.e., restrict) the values that the smallest displayed digit can change by. For example, if the setting is 2, the smallest digit will only take the values 0, 2, 4, 6, or 8 and if the setting is 5, it will only take the values 0 or 5. If the setting is 10, it will only take the value of 0.

Interruption Memory

- The minimum and maximum values when the power supply is turned OFF can be saved if interruption memory is turned ON.
- If interruption memory is ON, the maximum and minimum values after the last resetting will be displayed.
- If interruption memory is OFF, the maximum and minimum values will be displayed after the power supply is turned ON (or after the reset input is performed).

Output

Comparative Output Pattern

The output pattern for comparative outputs can be selected. In addition to high/low comparison with set values, output based on level changes is also possible. (Use the type of output pattern appropriate for the application.)

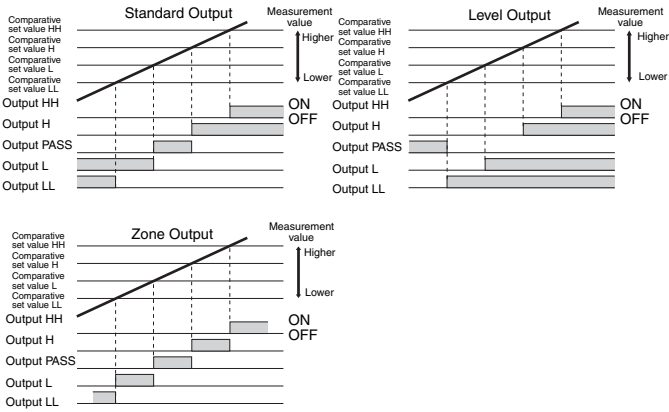

Output Logic

Reverses the output operation of comparative outputs for comparative results.

Hysteresis

Prevents comparative output chattering when the measurement value fluctuates slightly near the set value.

Example: Comparative Output Pattern (Standard Output)

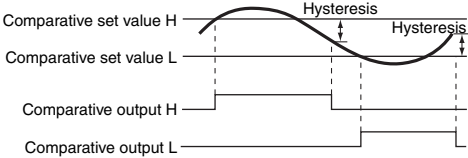

Startup Compensation Timer

Measurement can be stopped for a set time using external input. When S-TMR and COM are interconnected and the startup compensation timer is set, measurement will not be performed until a set time after the power supply is tuned ON.

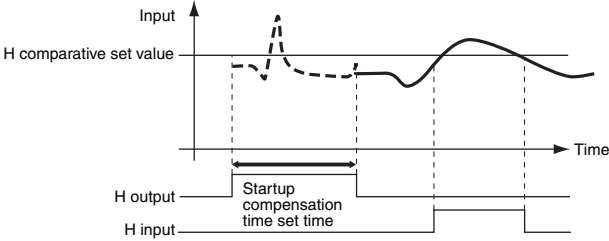

PASS Output Change

Comparative results other than PASS and error signals can be output from the PASS output terminal.

Dimensions

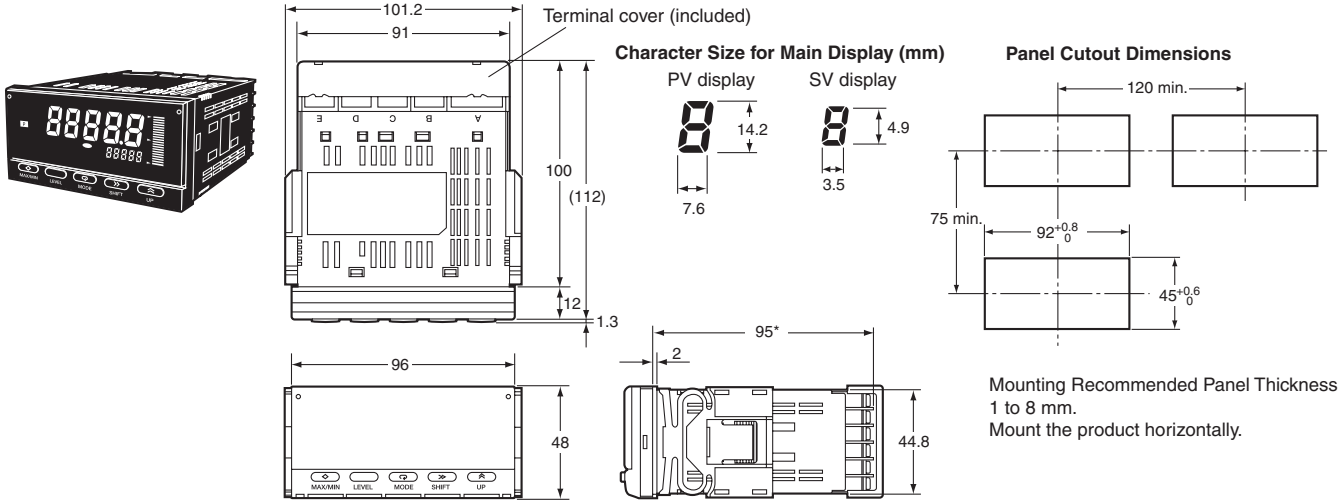

*DeviceNet models: 97 mm
Terminal: M3, Terminal Cover: Accessory

■ Wiring Precautions

- For terminal blocks, use the crimp terminals suitable for M3 screws.
- Tighten the terminal screws to the recommended tightening torque of approx. 0.5 N·m.
- To prevent inductive noise, separate the wiring for signal lines from that for power lines.

Wiring

- Use the crimp terminals suitable for M3 screws shown below.

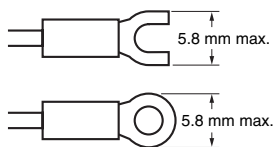

Unit Stickers

- Select the appropriate units from the unit sticker sheets provided and attach the sticker to the Indicator.

V	A	V	A	%	J	Pa	Ω
s	/	N	m	W	°C	m ³	k
°F	g	min	mm	rpm			
VA	mV	mA	Hz				
m/min	OMRON						
OUT	OUT						

Note: When using for meters, such as weighing meters, use the units specified by regulations on weights and measures.

■ Mounting Method

1. Insert the K3HB into the mounting cutout in the panel.
2. Insert watertight packing around the Unit to make the mounting watertight.

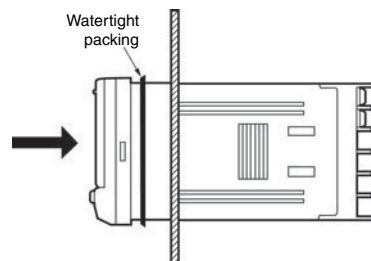

3. Insert the adapter into the grooves on the left and right sides of the rear case and push until it reaches the panel and is fixed in place.

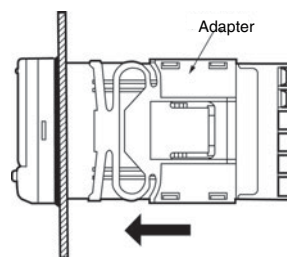

■ LCD Field of Vision

The K3HB is designed to have the best visibility at the angles shown in the following diagram.

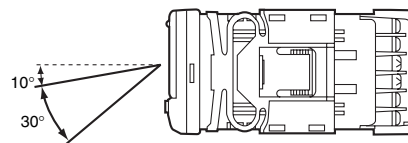

■ Rubber Packing (Sold Separately)

K32-P1

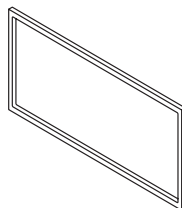

If the rubber packing is lost or damaged, it can be ordered using the following model number: K32-P1.

(Depending on the operating environment, deterioration, contraction, or hardening of the rubber packing may occur and so, in order to ensure the level of waterproofing specified in NEMA4, periodic replacement is recommended.)

Note: Rubber packing is provided with the Controller.

■ Safety Precautions

⚠ WARNING

Do not touch the terminals while power is being supplied. Doing so may possibly result in electric shock. Make sure that the terminal cover is installed before using the product.



Always provide protective circuits in the network. Without protective circuits, malfunctions may possibly result in accidents that cause serious injury or significant property damage.

Provide double or triple safety measures in external control circuits, such as emergency stop circuits, interlock circuits, or limit circuits, to ensure safety in the system if an abnormality occurs due to malfunction of the product or another external factor affecting the product's operation.



⚠ CAUTION

Do not allow pieces of metal, wire clippings, or fine metallic shavings or filings from installation to enter the product. Doing so may occasionally result in minor electric shock, fire, or malfunction.



Do not use the product in locations where flammable or explosive gases are present. Doing so may occasionally result in explosion, causing minor or moderate injury, or property damage.



Do not attempt to disassemble, repair, or modify the product. Doing so may occasionally result in minor or moderate injury due to electric shock.



Do not use the equipment for measurements within Measurement Categories III and IV for K3HB-X and II, III, and IV for K3HB-S, K3HB-V, and K3HB-H (according to IEC61010-1). Doing so may occasionally cause unexpected operation, resulting in minor or moderate injury, or damage to the equipment. Use the equipment for measurements only within the Measurement Category for which the product is designed.



Perform correct setting of the product according to the application. Failure to do so may occasionally cause unexpected operation, resulting in minor or moderate injury, or damage to the equipment.



Ensure safety in the event of product failure by taking safety measures, such as installing a separate monitoring system. Product failure may occasionally prevent operation of comparative outputs, resulting in damage to the connected facilities and equipment.



Tighten the screws on the terminal block and the connector locking screws securely using a tightening torque within the following ranges. Loose screws may occasionally cause fire, resulting in minor or moderate injury, or damage to the equipment.



Terminal block screws: 0.43 to 0.58 N·m

Connector locking screws: 0.18 to 0.22 N·m

Make sure that the product will not be adversely affected if the DeviceNet cycle time is lengthened as a result of changing the program with online editing. Extending the cycle time may cause unexpected operation, occasionally resulting in minor or moderate injury, or damage to the equipment.



Before transferring programs to other nodes or changing I/O memory of other nodes, check the nodes to confirm safety. Changing the program or I/O memory of other nodes may occasionally cause unexpected operation, resulting in minor or moderate injury, or damage to the equipment.



Precautions for Safe Use

- Do not use the product in the following locations.
 - Locations subject to direct radiant heat from heating equipment
 - Locations where the product may come into contact with water or oil
 - Locations subject to direct sunlight
 - Locations where dust or corrosive gases (in particular, sulfuric or ammonia gas) are present
 - Locations subject to extreme temperature changes
 - Locations where icing or condensation may occur
 - Locations subject to excessive shocks or vibration
- Do not use the product in locations subject to temperatures or humidity levels outside the specified ranges or in locations prone to condensation. If the product is installed in a panel, ensure that the temperature around the product (not the temperature around the panel) does not go outside the specified range.
- Provide sufficient space around the product for heat dissipation.
- Use and store the product within the specified temperature and humidity ranges. If several products are mounted side-by-side or arranged in a vertical line, the heat dissipation will cause the internal temperature of the products to rise, shortening the service life. If necessary, cool the products using a fan or other cooling method.
- The service life of the output relays depends on the switching capacity and switching conditions. Consider the actual application conditions and use the product within the rated load and electrical service life. Using the product beyond its service life may result in contact welding or burning.
- Install the product horizontally.
- Mount to a panel between 1 and 8-mm thick.
- Use the specified size of crimp terminals (M3, width: 5.8 mm max.) for wiring. To connect bare wires, use AWG22 (cross section: 0.326 mm²) to AWG14 (cross section: 2.081 mm²) to wire the power supply terminals and AWG28 (cross section: 0.081 mm²) to AWG16 (cross section: 1.309 mm²) for other terminals. (Length of exposed wire: 6 to 8 mm)
- In order to prevent inductive noise, wire the lines connected to the product separately from power lines carrying high voltages or currents. Do not wire in parallel with or in the same cable as power lines. Other measures for reducing noise include running lines along separate ducts and using shield lines.
- Ensure that the rated voltage is achieved no longer than 2 s after turning the power ON.
- Allow the product to operate without load for at least 15 minutes after the power is turned ON.
- Do not install the product near devices generating strong high-frequency waves or surges. When using a noise filter, check the voltage and current and install it as close to the product as possible.
- Do not use thinner to clean the product. Use commercially available alcohol.
- Be sure to confirm the name and polarity for each terminal before wiring the terminal block and connectors.
- Use the product within the noted supply voltage and rated load.
- Do not connect anything to unused terminals.
- Output turns OFF when the mode is changed or settings are initialized. Take this into consideration when setting up the control system.
- Install an external switch or circuit breaker that complies with applicable IEC60947-1 and IEC60947-3 requirements and label them clearly so that the operator can quickly turn OFF the power.
- Use the specified cables for the communications lines and stay within the specified DeviceNet communications distances. Refer to the User's Manual (Cat. No. N129) for details on communications distance specifications and cables.
- Do not pull the DeviceNet communications cables with excessive force or bend them past their natural bending radius.
- Do not connect or remove connectors while the DeviceNet power is being supplied. Doing so will cause product failure or malfunction.
- Use cables with a heat resistance of 70°C min.

■ Noise Countermeasures

1. Do not install the product near devices generating strong high-frequency waves or surges, such as high-frequency welding and sewing machines.
2. Mount a surge suppressor or noise filter to peripheral devices generating noise, in particular, motors, transformers, solenoids, and magnet coils.

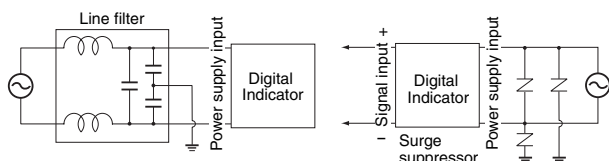

3. In order to prevent inductive noise, wire the lines connected to the terminal block separately from power lines carrying high voltages or currents. Do not wire in parallel with or in the same cable as power lines. Other measures for reducing noise include running lines along separate ducts and using shield lines.

Example of Countermeasures for Inductive Noise on Input Lines

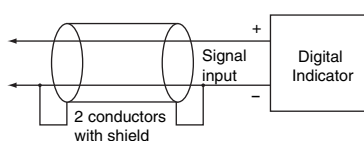

4. If a noise filter is used for the power supply, check the voltage and current, and install the noise filter as close to the product as possible.
5. Reception interference may occur if the product is used close to a radio, television, or wireless.

ALL DIMENSIONS SHOWN ARE IN MILLIMETERS.

To convert millimeters into inches, multiply by 0.03937. To convert grams into ounces, multiply by 0.03527.

In the interest of product improvement, specifications are subject to change without notice.