

2.5MHz 400mA Step-Down DC/DC Converter

General Description

The AAT1130 SwitchReg™ is a member of Skyworks' Total Power Management IC™ product family. The converter uses a predictive on-time, current-mode step-down control scheme that provides a fixed 2.5MHz switching frequency (under steady state conditions). It allows the control circuit to react nearly instantly in order to improve transient response and to enhance stability with the LC components as small as 1.0μH. The unique architecture improves transient response while allowing tiny passive LC filter components. The high switching frequency (up to 2.5MHz) keeps output voltage ripple low.

The AAT1130 delivers up to 400mA of output current, while consuming only 60μA of quiescent current. The AAT1130 regulates an output voltage between 0.6V and 1.8V from an input voltage of 2.7V to 5.5V. The AAT1130's output voltage is set by an external resistive voltage divider circuit. Internal MOSFET switches reduce the overall solution size while maintaining high efficiency over a wide load current range.

The AAT1130 is available in a space-saving 2.0x2.2mm SC70JW-10 package and is rated over the -40°C to 85°C temperature range.

Features

- 2.5MHz Switching Frequency
- Fast Transient Response with Small LC Output Filter Components
- Input Voltage Range: 2.7V to 5.5V
- Output Voltage Range: 0.6V to 1.8V
- High 92% Peak Efficiency ($V_{IN} = 3.6V, V_{OUT} = 1.8V$)
- Low 60μA Quiescent Current
- 400mA Maximum Continuous Output Current
- Internal 150μs Soft-Start Feedback Ramp
- Over-Temperature Protection
- Anti-Ringing Switch to Reduce EMI During Discontinuous Conduction Mode Operation
- Valley Current Limit Protection
- SC70JW-10 Package
- -40°C to 85°C Temperature Range

Applications

- Microprocessor/DSP Core and I/O
- Mobile Phones
- PDAs and Handheld Computers
- Digital Cameras
- Portable Music Players
- Handheld Games
- Handheld Instruments

Typical Application

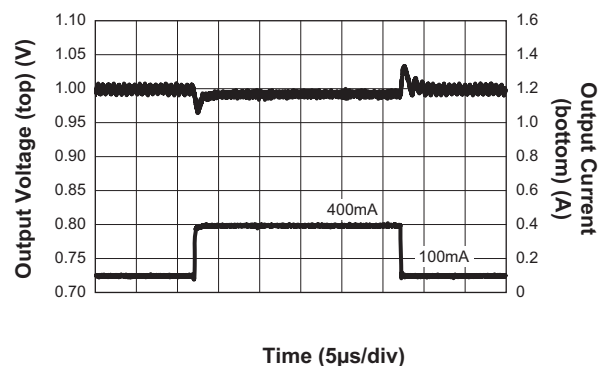
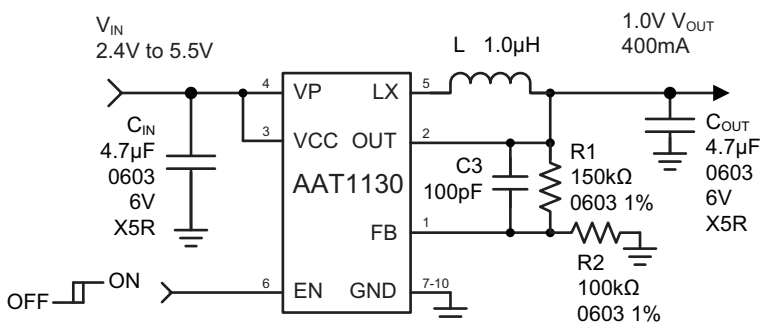

2.5MHz 400mA Step-Down DC/DC Converter**Pin Descriptions**

Pin #	Symbol	Function
1	FB	Output voltage feedback input. FB senses the output voltage through a resistor voltage divider circuit. Connect the voltage divider from the output voltage to FB. The feedback threshold is 0.6V.
2	VOUT	Output voltage sense input. VOUT senses the output voltage. Connect VOUT to the output voltage node for proper on-time calculation.
3	VCC	Input supply voltage. Connect VCC to the input supply voltage.
4	VP	Power input supply voltage. Connect VP to the VCC pin, and to the input supply voltage. Bypass VP to GND with a 2.2 μ F or greater ceramic capacitor.
5	LX	Switching node. Connect the LC filter between LX and the load. LX is internally connected to the drain of the p-channel MOSFET switch and n-channel MOSFET synchronous rectifier.
6	EN	Enable input. Active logic high.
7, 8, 9, 10	GND	Ground.

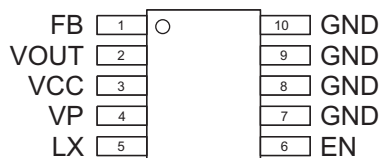
Pin Configuration**SC70JW-10
(Top View)**

2.5MHz 400mA Step-Down DC/DC Converter**Absolute Maximum Ratings¹**

Symbol	Description	Value	Units
V_{VCC}, V_{VP}	VCC, VP to GND	6.0	V
V_{LX}	LX Voltage to GND	-0.3 to $V_{VCC} \setminus V_{VP} + 0.3$	V
V_{FB}	FB Voltage to GND	-0.3 to $V_{VCC} \setminus V_{VP} + 0.3$	V
V_{EN}	EN Voltage to GND	-0.3 to $V_{VCC} \setminus V_{VP} + 0.3$	V
T_J	Operating Junction Temperature Range	-40 to 150	°C
T_{LEAD}	Maximum Soldering Temperature (at leads, 10 sec)	300	°C

Thermal Information

Symbol	Description	Value	Units
P_D	Maximum Power Dissipation	625	mW
θ_{JA}	Thermal Resistance ²	160	°C/W

1. Stresses above those listed in Absolute Maximum Ratings may cause permanent damage to the device. Functional operation at conditions other than the operating conditions specified is not implied. Only one Absolute Maximum Rating should be applied at any one time.
2. Mounted on a FR4 board.

2.5MHz 400mA Step-Down DC/DC Converter**Electrical Characteristics¹**

$V_{IN} = 3.6V$, $C_{IN} = C_{OUT} = 4.7\mu F$, $L = 1.5\mu H$. $T_A = -40^{\circ}C$ to $85^{\circ}C$, unless otherwise noted. Typical values are $T_A = 25^{\circ}C$.

Symbol	Description	Conditions	Min	Typ	Max	Units
V_{IN}	Input Voltage		2.7		5.5	V
V_{OUT}	Output Voltage Range		0.6		1.8	V
V_{UVLO}	UVLO Threshold	V_{IN} rising Hysteresis		100	2.65	mV
I_Q	Quiescent Current	Not Switching		60	90	μA
I_{SHDN}	Shutdown Current	EN = GND			1.0	μA
V_{FB_ACC}	Feedback Voltage Accuracy	$T_A = 25^{\circ}C$, No Load	0.59	0.6	0.61	V
I_{LIM}	Valley Current Limit	$T_A = 25^{\circ}C$	500	650		mA
$R_{DS(ON)H}$	High Side Switch On-Resistance			0.35		Ω
$R_{DS(ON)L}$	Low Side Switch On-Resistance			0.25		Ω
t_{ON}	Switch On-Time	$V_{IN} = 3.6V$, $V_{OUT} = 1.2V$		120		ns
$t_{OFF(MIN)}$	Minimum Off-Time			75		ns
I_{LXLEAK}	LX Leakage Current	$V_{IN} = 5.5$, $V_{LX} = 0$ to V_{IN}			1	μA
I_{FBLEAK}	FB Leakage Current	$V_{FB} = 5.5V$, $V_{EN} = 0V$, Adj Only			0.2	μA
t_S	Startup Time	From EN Asserted to Output Regulation		150		μs
f_S	Switching Frequency	$V_{OUT} = 1.2V$, 400mA Load		2.5		MHz
T_{SD}	Over-Temperature Shutdown Threshold			140		$^{\circ}C$
T_{HYS}	Over-Temperature Shutdown Hysteresis			15		$^{\circ}C$
$V_{EN(L)}$	Enable Threshold Low				0.6	V
$V_{EN(H)}$	Enable Threshold High		1.4			V
I_{EN}	Enable Pin Current	$V_{IN} = V_{FB} = 5.5V$	-1.0		1.0	μA

1. The AAT1130 is guaranteed to meet performance specifications over the $-40^{\circ}C$ to $+85^{\circ}C$ operating temperature range and is assured by design, characterization, and correlation with statistical process controls.

Typical Characteristics

Efficiency vs. Load Current
($V_{OUT} = 1V$)

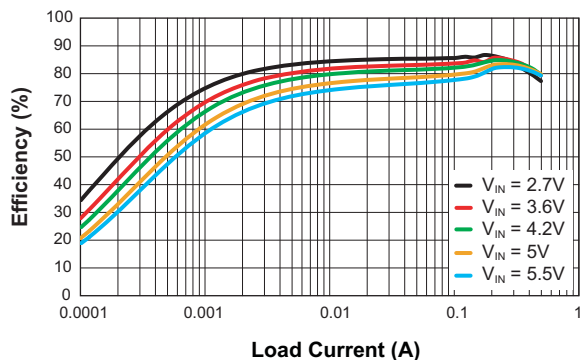

Output Voltage Error vs. Load Current
($V_{OUT} = 1V$)

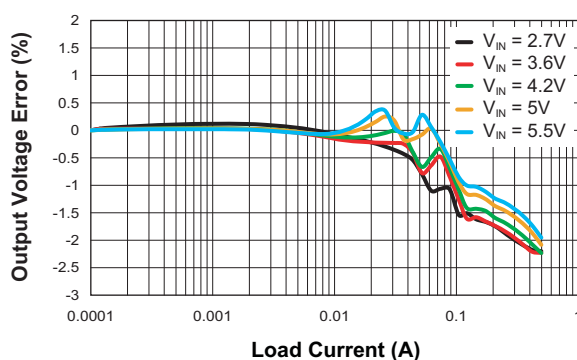

Line Regulation
($V_{OUT} = 1V$)

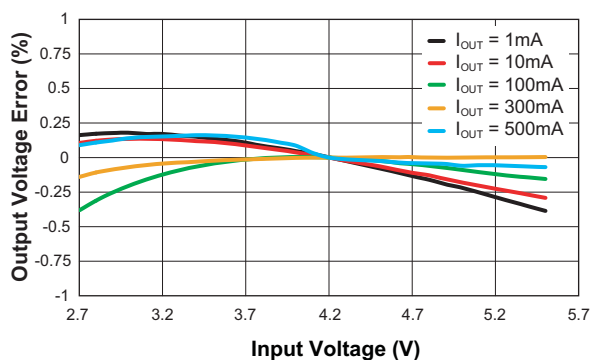

Efficiency vs. Load Current
($V_{OUT} = 1.8V$)

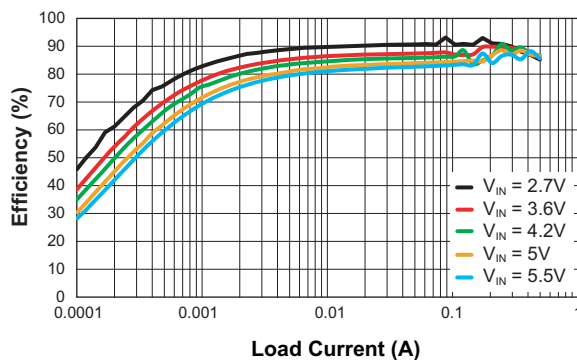

Output Voltage Error vs. Load Current
($V_{OUT} = 1.8V$)

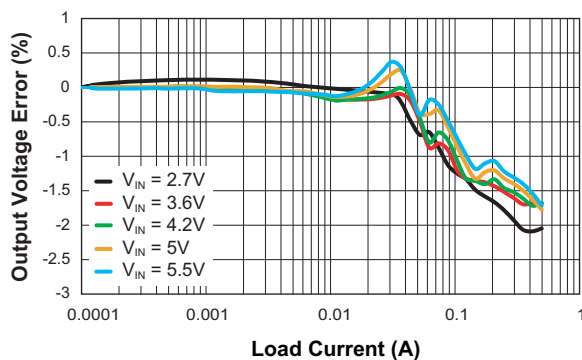

Line Regulation
($V_{OUT} = 1.8V$)

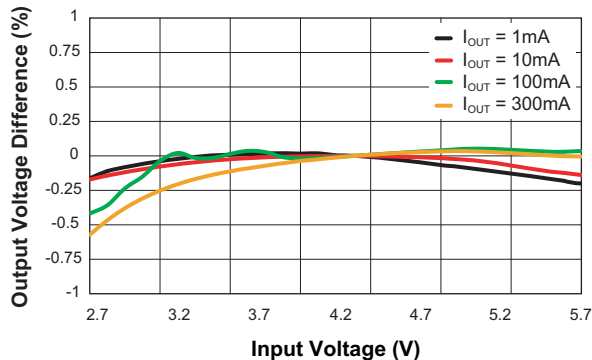

2.5MHz 400mA Step-Down DC/DC Converter

Typical Characteristics

Supply Current vs. Supply Voltage (Switching)

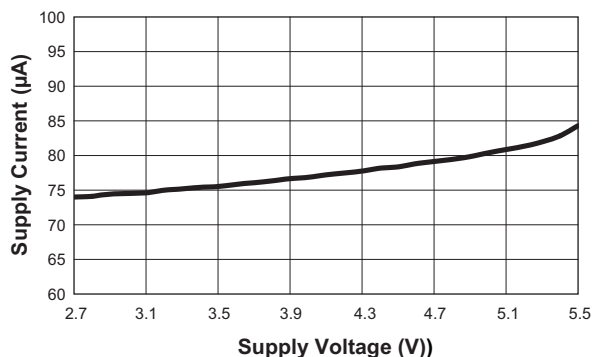

Switching Frequency vs. Input Voltage
($V_{OUT} = 1V$; $C_{IN} = C_{OUT} = 2.2\mu F$; $L = 1\mu H$)

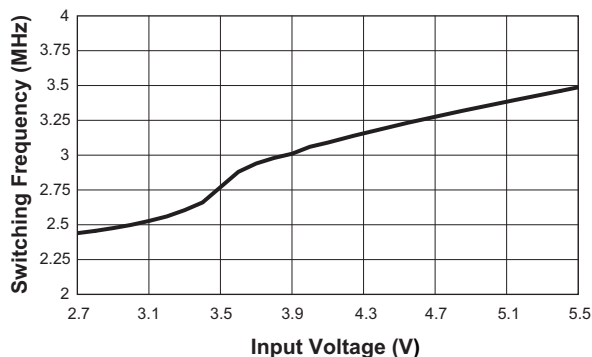

On-Time vs. Input Voltage
($V_{OUT} = 1V$; $C_{IN} = C_{OUT} = 2.2\mu F$; $L = 1\mu H$)

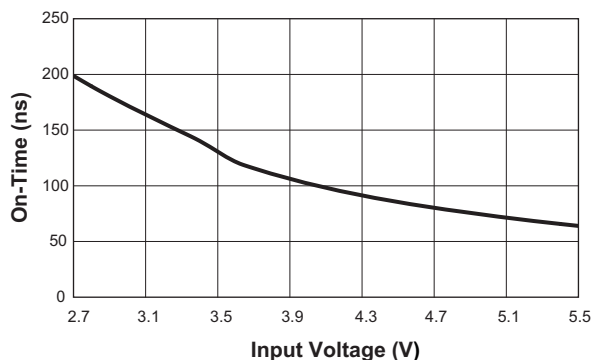

Switching Frequency vs. Input Voltage
($V_{OUT} = 1.8V$; $C_{IN} = C_{OUT} = 2.2\mu F$; $L = 1.5\mu H$)

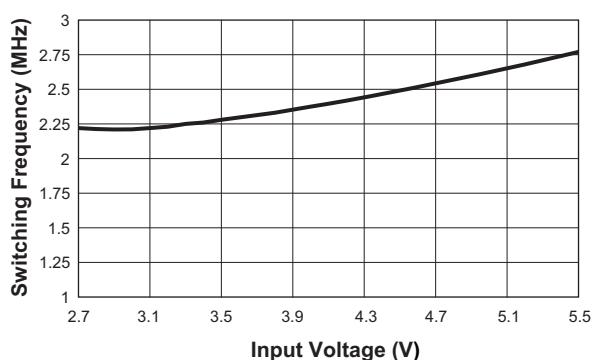

On-Time vs. Input Voltage
($V_{OUT} = 1.8V$; $C_{IN} = C_{OUT} = 2.2\mu F$; $L = 1.5\mu H$)

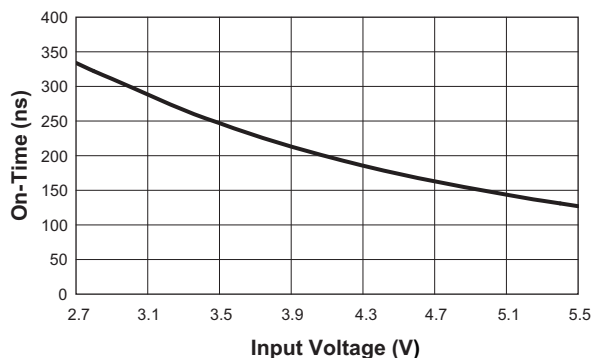

Switching Frequency Variation vs. Load Current

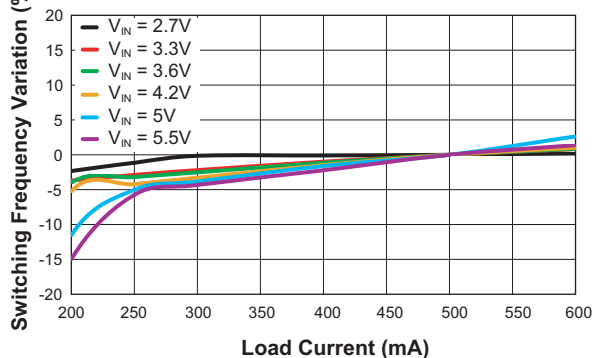

2.5MHz 400mA Step-Down DC/DC Converter

Typical Characteristics

Supply Current vs. Temperature

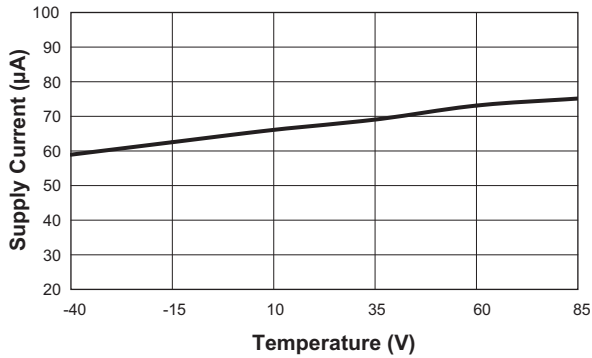

Output Voltage Error vs. Temperature

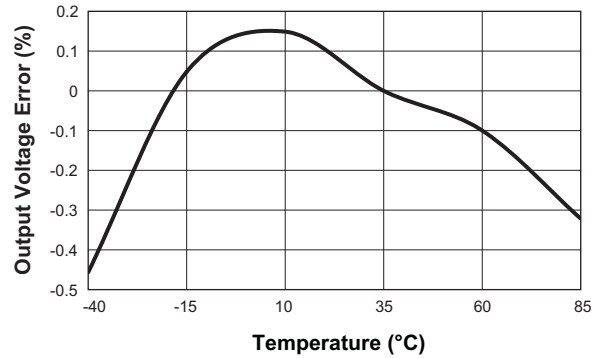

R_{DS(ON)} vs. Temperature

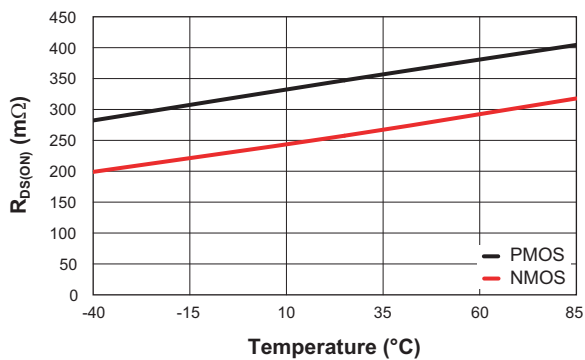

Switching Frequency vs. Output Voltage (I_{OUT} = 500mA)

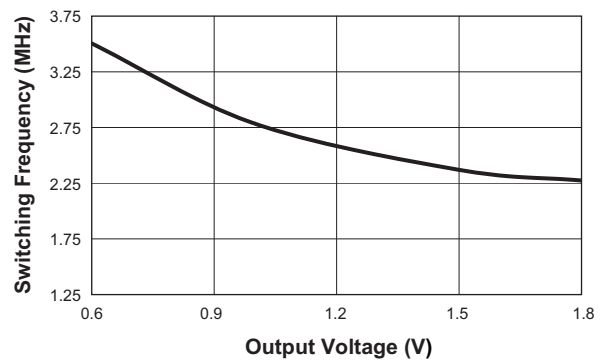

Load Transient

(V_{OUT} = 1.8V; V_{IN} = 3.6V; C_{OUT} = 4.7µF; C_{FF} = 100pF; L = 1.5µH)

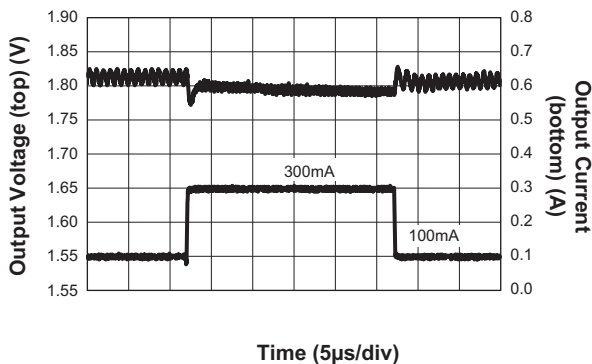

Load Transient

(V_{OUT} = 1.8V; V_{IN} = 3.6V; C_{OUT} = 4.7µF; L = 1.5µH)

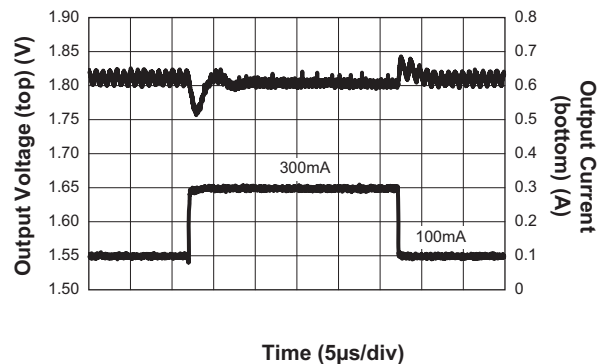

2.5MHz 400mA Step-Down DC/DC Converter

Typical Characteristics

Load Transient
 $(V_{OUT} = 1.8V; V_{IN} = 3.6V; C_{OUT} = 4.7\mu F; C_{FF} = 100pF; L = 1.5\mu H)$

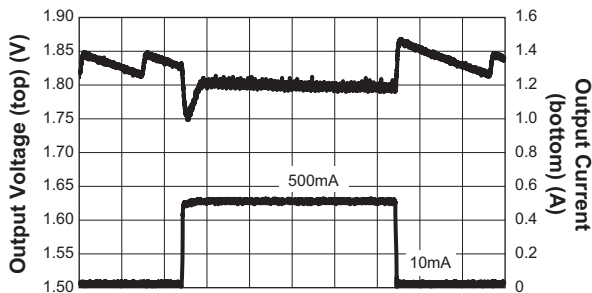

Time (5 μ s/div)

Load Transient
 $(V_{OUT} = 1.5V; V_{IN} = 3.6V; C_{OUT} = 4.7\mu F; C_{FF} = 100pF; L = 1.5\mu H)$

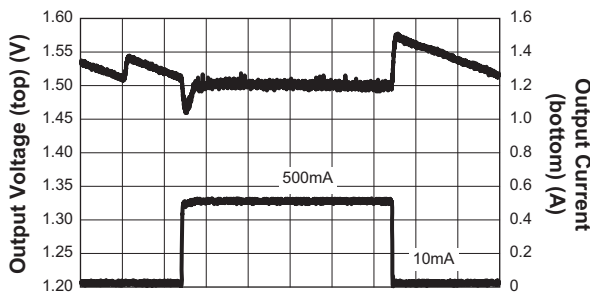

Time (5 μ s/div)

Load Transient
 $(V_{OUT} = 1.5V; V_{IN} = 3.6V; C_{OUT} = 4.7\mu F; L = 1.5\mu H)$

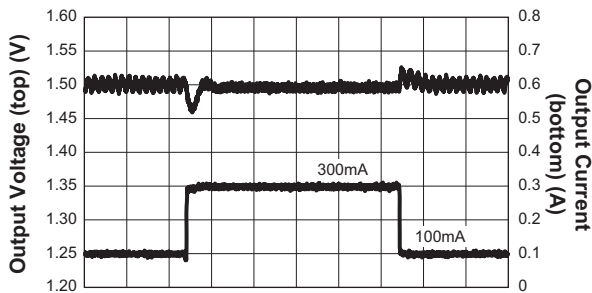

Time (5 μ s/div)

Load Transient
 $(V_{OUT} = 1V; V_{IN} = 3.6V; C_{OUT} = 4.7\mu F; C_{FF} = 100pF; L = 1\mu H)$

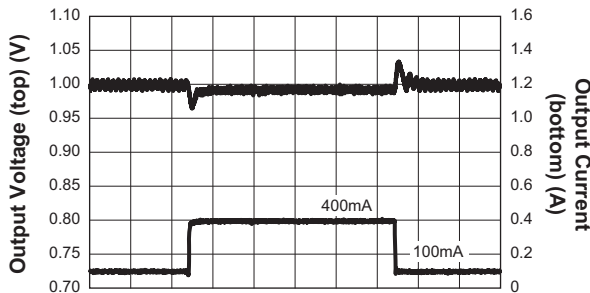

Time (5 μ s/div)

Load Transient
 $(V_{OUT} = 1V; V_{IN} = 3.6V; C_{OUT} = 4.7\mu F; L = 1\mu H)$

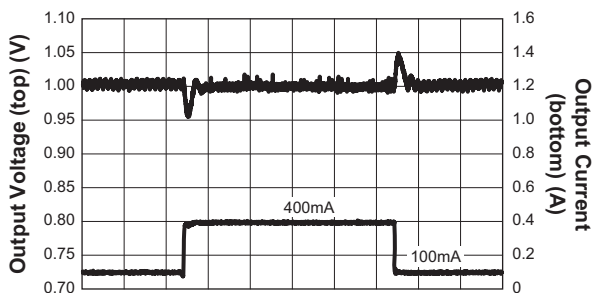

Time (5 μ s/div)

Load Transient
 $(V_{OUT} = 1V; V_{IN} = 3.6V; C_{OUT} = 4.7\mu F; C_{FF} = 100pF; L = 1\mu H)$

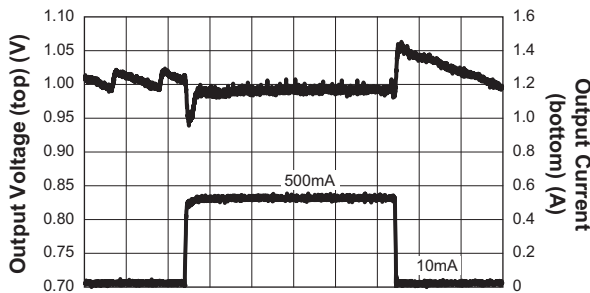

Time (5 μ s/div)

2.5MHz 400mA Step-Down DC/DC Converter

Typical Characteristics

Soft-Start

($V_{OUT} = 1.8V$; $V_{IN} = 3.6V$; $C_{OUT} = 4.7\mu F$; $L = 1.5\mu H$)

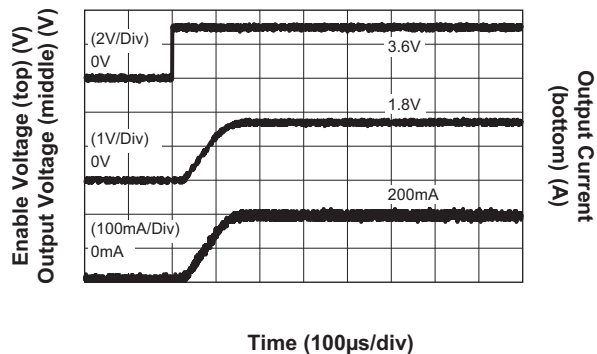

Line Transient

($V_{OUT} = 1.8V$; $C_{OUT} = 4.7\mu F$; $L = 1.5\mu H$)

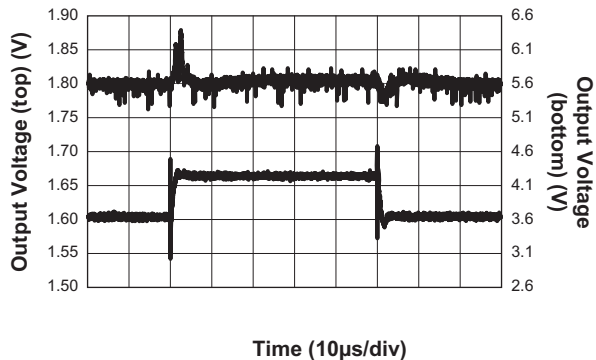

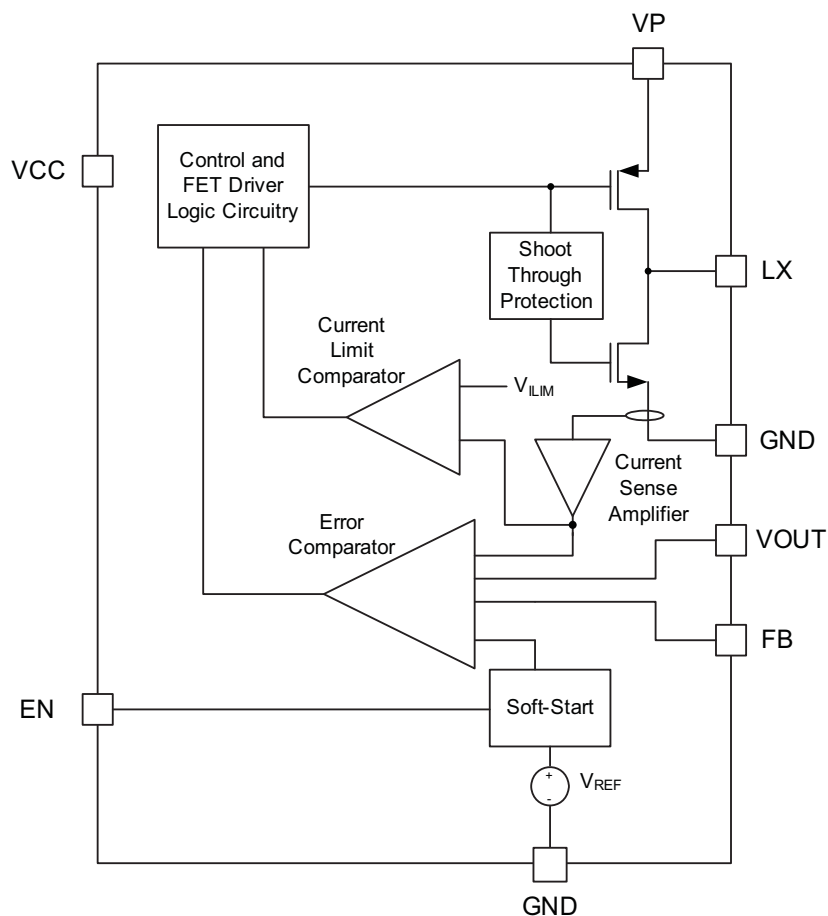
Functional Block Diagram**Functional Description**

The AAT1130 is a high performance 400mA 2.5MHz (maximum switching frequency during steady-state operation) monolithic step-down converter. It minimizes external component size, enabling the use of a tiny 0603 inductor that is only 1mm tall, and optimizes efficiency over the complete load range. Apart from the small bypass input capacitor, only a small L-C filter is required at the output. Typically, a 1 μ H inductor and a 4.7 μ F ceramic capacitor are recommended for <1.2V output voltage applications (see table of values).

Only three external power components (C_{IN} , C_{OUT} , and L) are required. Output voltage is programmed with external feedback resistors, ranging from 0.6V to 1.8V. An additional feed-forward capacitor can also be added to the external feedback to provide improved transient response (see Figure 1).

The input voltage range is 2.7V to 5.5V. The converter efficiency has been optimized for all load conditions, ranging from no load to 400mA.

The internal error comparator and incorporated compensation provide excellent transient response, load, and line regulation. Soft-start eliminates any output voltage overshoot when the enable or the input voltage is applied.

Control Loop

The AAT1130 uses a current-mode control scheme that allows it to operate at very high switching frequencies. The current-mode control scheme operates with a predicted on-time for a given output to input voltage ratio. The on-time varies inversely proportional to the input voltage and proportional to the output voltage giving the regulator a fixed switching frequency when in steady-state. This allows the use of very small external inductor and capacitor. The small size coupled with the low quies-

2.5MHz 400mA Step-Down DC/DC Converter

cent current and automatic transition to variable switching frequency mode makes it ideal for small battery operated applications.

Light Load Operation

The AAT1130 monitors the synchronous rectifier current and when the current drops to zero, it turns off the synchronous rectifier to emulate an actual rectifier. This allows the regulator to operate in discontinuous conduction mode. In this mode the on-time remains the same as it is in continuous conduction mode, and therefore the inductor ripple current remains the same in both modes. But reduced load current requires more time for the output capacitor to discharge to the regulation voltage reducing the switching frequency. This has the added benefit of reducing the switching transition losses improving efficiency at light loads.

Stability

The AAT1130 requires no additional compensation components to guarantee stability. The only requirement for stability is to choose the appropriate output capacitor.

Current-mode control simplifies compensation by controlling the inductor current to regulate the output voltage. This approximates a single pole response in the loop gain even though a complex pole pair exists due to the LC filter. Therefore the crossover frequency is approximated as the DC loop gain multiplied by the single pole. The AAT1130 DC loop gain is a function of the 60mΩ current sense resistor and is determined by the equation:

$$A_{\text{LOOP(DC)}} = \frac{V_{\text{OUT}}}{0.6\text{V}} \cdot \frac{R_{\text{LOAD}}}{60\text{m}\Omega}$$

And the dominant pole frequency is:

$$f_p = \frac{1}{2\pi \cdot R_{\text{LOAD}} \cdot C_{\text{OUT}}}$$

Therefore the crossover frequency is:

$$\begin{aligned} f_c &= A_{\text{LOOP(DC)}} \cdot f_p \\ &= \frac{V_{\text{OUT}}}{2\pi \cdot 0.6\text{V} \cdot 60\text{m}\Omega \cdot C_{\text{OUT}}} \end{aligned}$$

The only requirement for stability is that the crossover frequency be much less than the 2.5MHz switching frequency. The crossover frequency can be as high as 1/2 of the switching frequency, or 1.25MHz. Therefore calculate the output capacitor by the equation:

$$C_{\text{OUT}} > \frac{V_{\text{OUT}}}{2\pi \cdot 0.6\text{V} \cdot 60\text{m}\Omega \cdot 1.25\text{MHz}}$$

Example:

Given that $V_{\text{OUT}} = 1.5\text{V}$, then $C_{\text{OUT}} > 5.3\mu\text{F}$, therefore a 4.7μF capacitor is the closest standard value that can be used for 1.2V to 1.5V output.

Due to the unique control method, the “inside” current control loop does not have the inherent instability that plagues most fixed frequency current-mode DC-DC regulators.

Soft-Start

When the AAT1130 is enabled, it enters soft-start mode. In this mode, the output voltage slowly rises over 150μs allowing the output capacitor to charge without drawing excessive input current. This feature prevents overstressing the battery or other input power source.

Valley Current Limit

The AAT1130 includes a cycle-by-cycle, valley current limit to prevent damage to itself or the external components. The valley current limit uses the low-side-N-Channel synchronous rectifier to monitor the inductor current. If the measured current exceeds the valley current limit, the AAT1130 keeps the low-side synchronous rectifier on until the current drops below the current limit. Along with the predictive on-time control scheme, the valley current limit protection allows the converter to control and limit the inductor current, even with output overload or short-circuit fault condition.

Since the AAT1130 uses a predictive on-time architecture (constant on-time with input feed-forward), the actual output current capability is a function of the inductor ripple current (ΔI_L) and the current limit comparator delay (see Figure 1):

$$I_{\text{OUT_MAX}} = I_{\text{LIM_VALLEY}} + \frac{\Delta I_L}{2} - \left(\frac{V_{\text{OUT}}}{L}\right) \cdot t_{\text{DELAY}}$$

$$I_{\text{OUT_MAX}} = I_{\text{LIM_VALLEY}} + \left(\frac{V_{\text{IN}} - V_{\text{OUT}}}{2L}\right) \cdot \left(\frac{V_{\text{OUT}}}{V_{\text{IN}}}\right) \cdot t_{\text{SW}} - \left(\frac{V_{\text{OUT}}}{L}\right) \cdot t_{\text{DELAY}}$$

2.5MHz 400mA Step-Down DC/DC Converter

Where t_{SW} is the switching period constant (typically 360ns) as defined by the on-time specification in the Electrical Characteristics table, and t_{DELAY} is the current-limit comparator delay (typically 150ns).

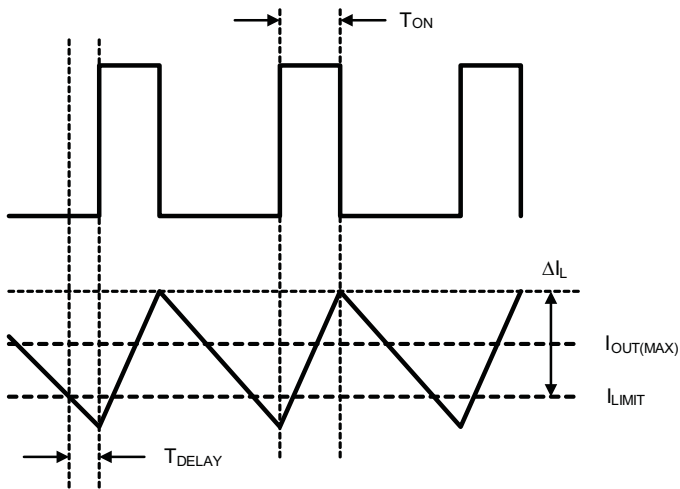

Figure 1: Output Current to Valley Current-Limit Relationship

Anti-Ringing Switch

The AAT1130 includes an anti-ringing switch that dissipates any energy left in the inductor when the current is approximately zero. The anti-ringing switch turns on when both the p-channel switch and n-channel synchronous rectifier are off and the inductor current is approximately zero. The switch shorts the LX and VOUT nodes together, effectively shorting the inductor. The low on-resistance of the anti-ringing switch dissipates any energy left in the inductor preventing ringing at light loads. When either the switch or synchronous rectifier are on, the anti-ringing switch remains off.

Over-Temperature

The AAT1130 includes thermal protection that automatically turns off the regulator when the die temperature exceeds a safe level. The thermal protection turns on at a die temperature of 140°C and has a 15°C hysteresis.

Applications Information

Inductor Selection

The step-down converter uses a predictive on-time control scheme with internal slope and current compensation. The internal current compensation eliminates the "minimum, output capacitor ESR" stability requirement commonly required with this control architecture. However, the current compensation requires that the inductor current down slope to maintain a sufficient signal-to-noise ratio. The inductor current down-slope is defined by:

$$\frac{di}{dt} = \frac{V_{OUT}}{L}$$

resulting in an inductor recommendation to keep the inductance value equal to the output voltage $L = V_{OUT} \frac{\mu H}{V}$ to maintain the appropriate $\frac{di}{dt}$.

Manufacturer's specifications list both the inductor DC current rating, which is a thermal limitation, and the peak current rating, which is determined by the saturation characteristics. The inductor should not show any appreciable saturation under normal load conditions. Some inductors may meet the peak and average current ratings yet result in excessive losses due to a high DCR. Always consider the losses associated with the DCR and its effect on the total converter efficiency when selecting an inductor. See Table 2 for suggested inductor values and vendors.

Input Capacitor

Select a 4.7μF to 10μF X7R or X5R ceramic capacitor for the input. Always examine the ceramic capacitor DC voltage coefficient characteristics when selecting the proper value. For example, the capacitance of a 10μF, 6.3V, X5R ceramic capacitor with 5.0V DC applied is actually about 6μF.

The input capacitor provides a low impedance loop for the edges of pulsed current drawn by the AAT1130. Low ESR/ESL X7R and X5R ceramic capacitors are ideal for this function. To minimize stray inductance, the capacitor should be placed as closely as possible to the IC. This keeps the high frequency content of the input current localized, minimizing EMI and input voltage ripple.

The proper placement of the input capacitor (C1) can be seen in the evaluation board layouts in Figures 4 and 5.

2.5MHz 400mA Step-Down DC/DC Converter

A laboratory test set-up typically consists of two long wires running from the bench power supply to the evaluation board input voltage pins. The inductance of these wires, along with the low-ESR ceramic input capacitor, can create a high Q network that may affect converter performance. This problem often becomes apparent in the form of excessive ringing in the output voltage during load transients. Errors in the loop phase and gain measurements can also result.

Since the inductance of a short PCB trace feeding the input voltage is significantly lower than the power leads from the bench power supply, most applications do not exhibit this problem. In applications where the input power source lead inductance cannot be reduced to a level that does not affect the converter performance, a high ESR tantalum or aluminum electrolytic should be placed in parallel with the low ESR, ESL bypass ceramic. This dampens the high Q network and stabilizes the system.

Output Capacitor

The output capacitor limits the output ripple and provides holdup during large load transitions. A 4.7µF to 10µF X5R or X7R ceramic capacitor typically provides sufficient bulk capacitance to stabilize the output during large load transitions and has the ESR and ESL characteristics necessary for low output ripple.

The internal voltage loop compensation also limits the minimum output capacitor value to 4.7µF. This is due to its effect on the loop crossover frequency (bandwidth), phase margin, and gain margin. Increased output capacitance will reduce the crossover frequency with greater phase margin.

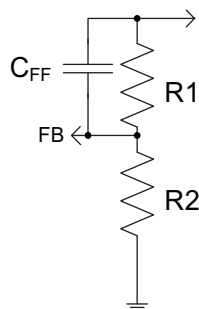

Figure 2: AAT1130 External Resistor Output Voltage Programming.

Feedback Resistor Selection

Resistors R1 and R2 of Figure 2 program the output to regulate at a voltage higher than 0.6V. To limit the bias current required for the external feedback resistor string while maintaining good noise immunity, the minimum suggested value for R2 is 59kΩ. Although a larger value will further reduce quiescent current, it will also increase the impedance of the feedback node, making it more sensitive to external noise and interference. Table 1 summarizes the resistor values for various output voltages with R2 set to either 59kΩ for good noise immunity or 221kΩ for reduced no load input current.

$$R1 = \left(\frac{V_{OUT}}{V_{FB}} - 1 \right) \cdot R2 = \left(\frac{1.5V}{0.6V} - 1 \right) \cdot 59k\Omega = 88.5k\Omega$$

The AAT1130, combined with an external feedforward capacitor (C3 in Figure 2), delivers enhanced transient response for extreme pulsed load applications. The addition of the feedforward capacitor typically requires a larger output capacitor C1 for stability.

V _{OUT} (V)	R2 = 59kΩ R1 (kΩ)	R2 = 221kΩ R1 (kΩ)
0.9	29.4	113
1	39.2	150
1.1	49.9	187
1.2	59.0	221
1.3	68.1	261
1.4	78.7	301
1.5	88.7	332
1.8	118	442

Table 1: Feedback Resistor Values.

Thermal Calculations

There are three types of losses associated with the AAT1130 step-down converter: switching losses, conduction losses, and quiescent current losses. Conduction losses are associated with the R_{DS(ON)} characteristics of the power output switching devices. Switching losses are dominated by the gate charge of the power output switching devices. At full load, assuming continuous conduction mode (CCM), a simplified form of the losses is given by:

$$P_{TOTAL} = \frac{I_O^2 \cdot (R_{DS(ON)H} \cdot V_O + R_{DS(ON)L} \cdot [V_{IN} - V_O])}{V_{IN}} + (t_{sw} \cdot F_S \cdot I_O + I_Q) \cdot V_{IN}$$

2.5MHz 400mA Step-Down DC/DC Converter

I_Q is the step-down converter quiescent current. The term t_{sw} is used to estimate the full load step-down converter switching losses. For the condition where the step-down converter is in dropout at 100% duty cycle, the total device dissipation reduces to:

$$P_{TOTAL} = I_O^2 \cdot R_{DS(ON)H} + I_Q \cdot V_{IN}$$

Since $R_{DS(ON)}$, quiescent current, and switching losses all vary with input voltage, the total losses should be investigated over the complete input voltage range. Given the total losses, the maximum junction temperature can be derived from the θ_{JA} for the SC70JW-10 package which is 160°C/W.

$$T_{J(MAX)} = P_{TOTAL} \cdot \theta_{JA} + T_{AMB}$$

Layout

The suggested PCB layout for the AAT1130 is shown in Figures 4 and 5. The following guidelines should be used to help ensure a proper layout:

1. The input capacitor (C1) should connect as closely as possible to the VCC/VP and GND pins.
2. C1 and L1 should be connected as closely as possible. The connection of L1 to the LX pin should be as short as possible.
3. The feedback trace or FB pin for adjustable output voltage should be separate from any power trace and connect as closely as possible to the load point. Sensing along a high current load trace will degrade DC load regulation. If external feedback resistors are used, they should be placed as closely as possible to the FB pin for adjustable output voltage to minimize the length of the high impedance feedback trace.
4. The resistance of the trace from the load return to the GND pins should be kept to a minimum. This will help to minimize any error in DC regulation due to differences in the potential of the internal signal ground and the power ground.

AAT1130

2.5MHz 400mA Step-Down DC/DC Converter

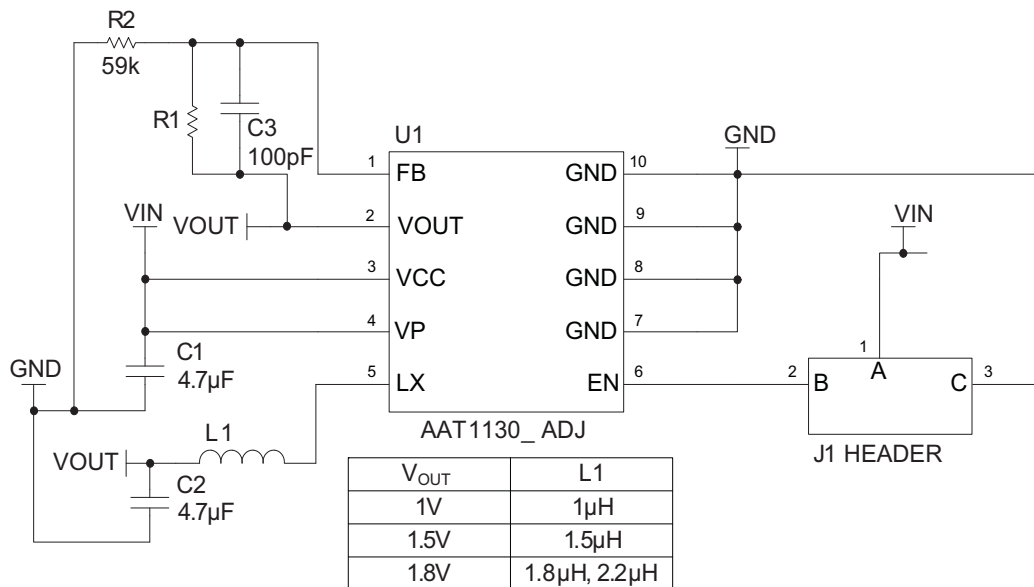

- U1 AAT1130 Analogic Technologies, 2.5MHz, 400mA Buck Converter
- C1, C2 Cap, MLC, 4.7 μ F/6.3V, 0805
- C3 Cap, MLC, 100pF/6.3V, 0402 (optional)
- R1 Carbon film resistor, 0402 (adjust to output voltage)
- R2 Carbon film resistor, 59k Ω , 0402
- L1 LQM2HP-GO, 1.5 μ H, Murata, I_{SAT} = 1.5A, DCR = 70m Ω ;
or VLF3010A, 1.5 μ H, TDK, I_{SAT} = 1.2A, DCR = 68m Ω

Figure 3: AAT1130 Evaluation Board Schematic.

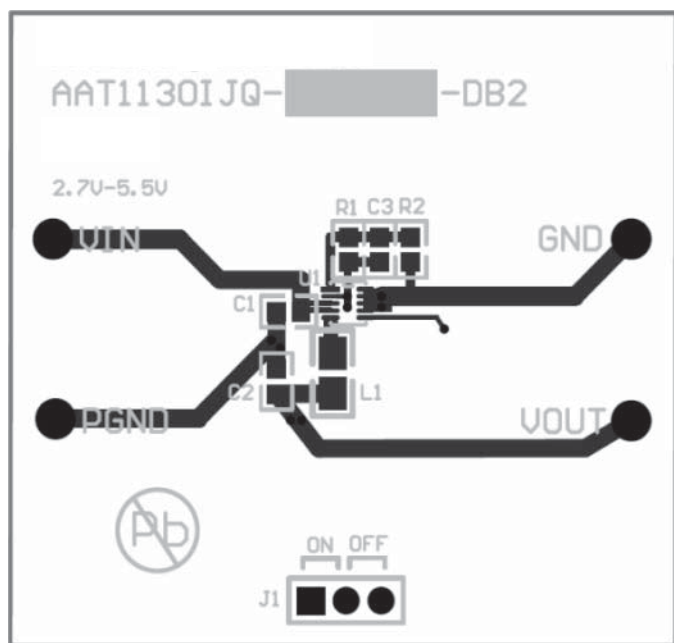

Figure 4: AAT1130 Evaluation Board Top Side PCB Layout.

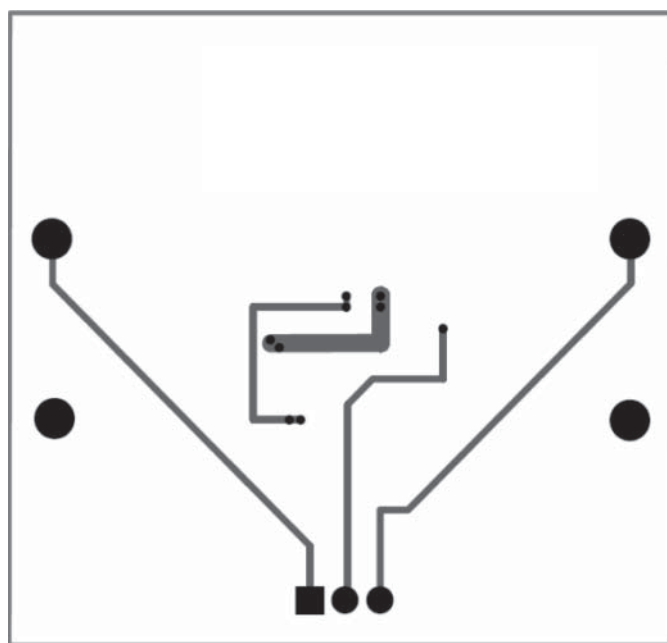

Figure 5: AAT1130 Evaluation Board Bottom Side PCB Layout.

2.5MHz 400mA Step-Down DC/DC Converter

Manufacturer	Part Number/Type	Inductance (μH)	Rated Current (mA)	DCR (mΩ) (typ)	Size (mm) LxWxH
Murata	LQM2HP_G0	1	1600	55	2.5x2x1
		1.5	1500	70	
		2.2	1300	80	
	LQH32P_N0	1	2050	45	3.2x2.5x1.6
		1.5	1750	57	
		2.2	1600	76	
TDK	GLC2518	1	2.8	20	2.5x1.8x1.8
		2.2	2.45	25	
	VLF3010A	1.5	1200	68	2.8x2.6x1
		2.2	1000	100	
	VLF3010S	1	1700	41	3.0x2.8x1
		2.2	1100	77	

Table 2: Suggested Inductor Components.

Manufacturer	Part Number	Value	Voltage	Temp. Co.	Case
AVX	0603ZD225K	2.2μF	10	X5R	0603
TDK	C1608X5R1C225K	2.2μF	16	X5R	0603
	C1608X5R1A475K	4.7μF	10		0805
	C2012X5R1A106K	10μF	10		1206
	C3216X5R1A226K	22μF	10		
Murata	GRM188R61A225K	2.2μF	10	X5R	0603
	GRM219R61A106K	10μF	10		0805
	GRM31CR71A226K	22μF	10	X7R	1206
Taiyo Yuden	LMK107BJ475KA	4.7μF	10	X5R	0603

Table 3: Suggested Capacitor Components.

AAT1130

2.5MHz 400mA Step-Down DC/DC Converter

Ordering Information

Output Voltage	Package	Marking ¹	Part Number (Tape and Reel) ²
Adjustable	SC70JW-10	2VXXY	AAT1130IJQ-0.6-T1

 Skyworks Green™ products are compliant with all applicable legislation and are halogen-free. For additional information, refer to *Skyworks Definition of Green™*, document number SQ04-0074.

Package Information

SC70JW-10

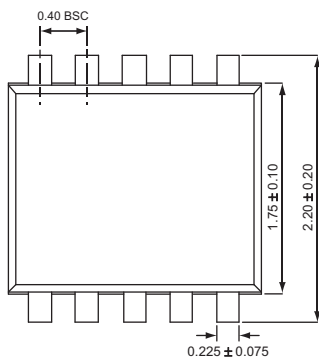

Top View

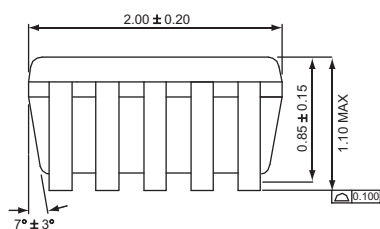

Side View

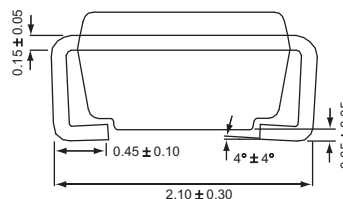

End View

All dimensions in millimeters.

1. XYY = assembly and date code.
 2. Sample stock is generally held on part numbers listed in **BOLD**

2.5MHz 400mA Step-Down DC/DC Converter

Copyright © 2012, 2013 Skyworks Solutions, Inc. All Rights Reserved.

Information in this document is provided in connection with Skyworks Solutions, Inc. ("Skyworks") products or services. These materials, including the information contained herein, are provided by Skyworks as a service to its customers and may be used for informational purposes only by the customer. Skyworks assumes no responsibility for errors or omissions in these materials or the information contained herein. Skyworks may change its documentation, products, services, specifications or product descriptions at any time, without notice. Skyworks makes no commitment to update the materials or information and shall have no responsibility whatsoever for conflicts, incompatibilities, or other difficulties arising from any future changes.

No license, whether express, implied, by estoppel or otherwise, is granted to any intellectual property rights by this document. Skyworks assumes no liability for any materials, products or information provided hereunder, including the sale, distribution, reproduction or use of Skyworks products, information or materials, except as may be provided in Skyworks Terms and Conditions of Sale.

THE MATERIALS, PRODUCTS AND INFORMATION ARE PROVIDED "AS IS" WITHOUT WARRANTY OF ANY KIND, WHETHER EXPRESS, IMPLIED, STATUTORY, OR OTHERWISE, INCLUDING FITNESS FOR A PARTICULAR PURPOSE OR USE, MERCHANTABILITY, PERFORMANCE, QUALITY OR NON-INFRINGEMENT OF ANY INTELLECTUAL PROPERTY RIGHT; ALL SUCH WARRANTIES ARE HEREBY EXPRESSLY DISCLAIMED. SKYWORKS DOES NOT WARRANT THE ACCURACY OR COMPLETENESS OF THE INFORMATION, TEXT, GRAPHICS OR OTHER ITEMS CONTAINED WITHIN THESE MATERIALS. SKYWORKS SHALL NOT BE LIABLE FOR ANY DAMAGES, INCLUDING BUT NOT LIMITED TO ANY SPECIAL, INDIRECT, INCIDENTAL, STATUTORY, OR CONSEQUENTIAL DAMAGES, INCLUDING WITHOUT LIMITATION, LOST REVENUES OR LOST PROFITS THAT MAY RESULT FROM THE USE OF THE MATERIALS OR INFORMATION, WHETHER OR NOT THE RECIPIENT OF MATERIALS HAS BEEN ADVISED OF THE POSSIBILITY OF SUCH DAMAGE.

Skyworks products are not intended for use in medical, lifesaving or life-sustaining applications, or other equipment in which the failure of the Skyworks products could lead to personal injury, death, physical or environmental damage. Skyworks customers using or selling Skyworks products for use in such applications do so at their own risk and agree to fully indemnify Skyworks for any damages resulting from such improper use or sale.

Customers are responsible for their products and applications using Skyworks products, which may deviate from published specifications as a result of design defects, errors, or operation of products outside of published parameters or design specifications. Customers should include design and operating safeguards to minimize these and other risks. Skyworks assumes no liability for applications assistance, customer product design, or damage to any equipment resulting from the use of Skyworks products outside of stated published specifications or parameters.

Skyworks, the Skyworks symbol, and "Breakthrough Simplicity" are trademarks or registered trademarks of Skyworks Solutions, Inc., in the United States and other countries. Third-party brands and names are for identification purposes only, and are the property of their respective owners. Additional information, including relevant terms and conditions, posted at www.skyworksinc.com, are incorporated by reference.