

Dual IGBTMOD™ HVIGBT Module 150 Amperes/4500 Volts

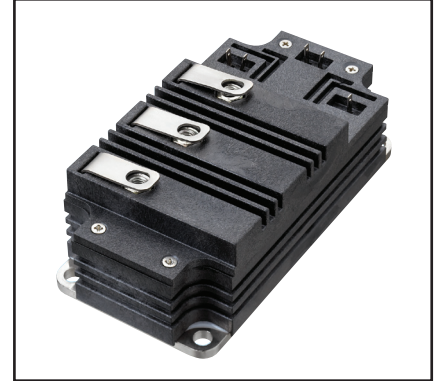
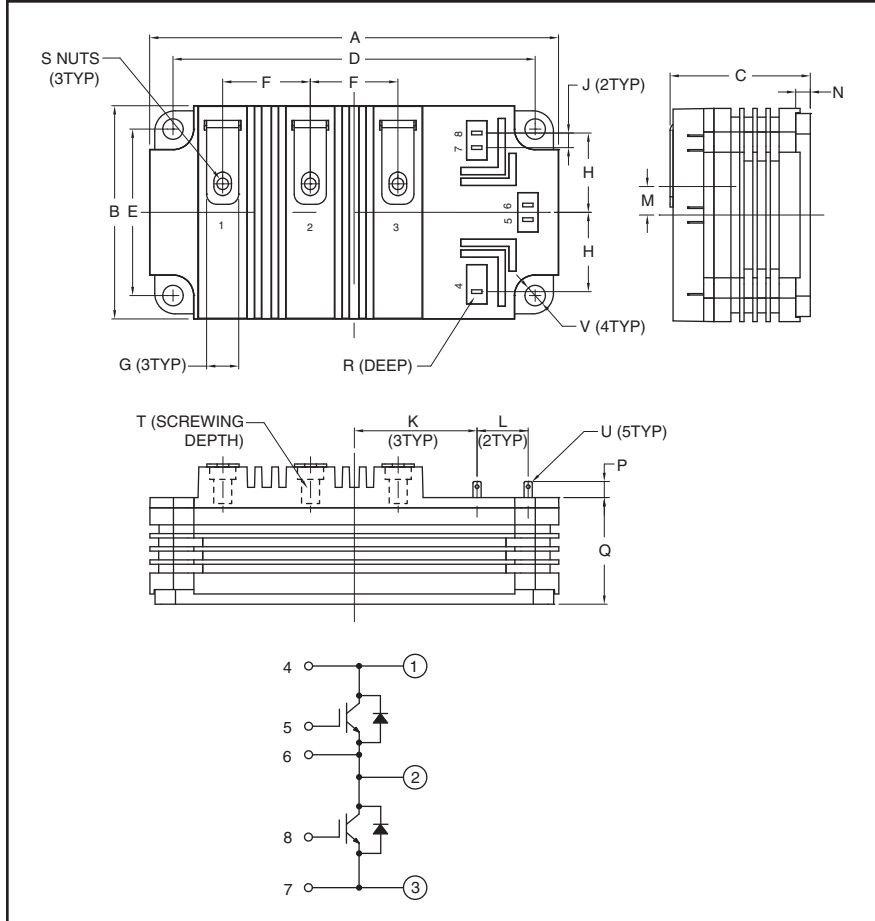

Description:

Powerex IGBTMOD™ Modules are designed for use in switching applications. Each module consists of two IGBT Transistors in a half-bridge configuration with each transistor having a reverse-connected super-fast recovery free-wheel diode. All components and interconnects are isolated from the heat sinking baseplate, offering simplified system assembly and thermal management.

Features:

- Low $V_{CE(sat)}$
- Creepage and Clearance meet IEC 60077-1
- High Isolation Voltage
- Rugged SWSOA and RRSOA
- Compact Industry Standard Package

Applications:

- Traction
- Medium Voltage Drives
- High Voltage Power Supplies

Outline Drawing and Circuit Diagram

Dimensions	Inches	Millimeters
A	5.51	140.0
B	2.87	73.0
C	1.89	48.0
D	4.88±0.01	124.0±0.25
E	2.24±0.01	57.0±0.25
F	1.18	30.0
G	0.43	11.0
H	1.07	27.15
J	0.20	5.0
K	1.65	42.0

Dimensions	Inches	Millimeters
L	0.69±0.01	17.5±0.25
M	0.38	9.75
N	0.20	5.0
P	0.22	5.5
Q	1.44	36.5
R	0.16	4.0
S	M6 Metric	M6
T	0.63 Min.	16.0 Min.
U	0.11 x 0.02	2.8 x 0.5
V	0.28 Dia.	7.0 Dia.

QID4515001
Dual IGBTMOD™ HVIGBT Module
 150 Amperes/4500 Volts

Absolute Maximum Ratings, $T_j = 25\text{ }^\circ\text{C}$ unless otherwise specified

Ratings	Symbol	QID4515001	Units
Junction Temperature	T_j	-40 to 150	$^\circ\text{C}$
Storage Temperature	T_{stg}	-40 to 125	$^\circ\text{C}$
Collector-Emitter Voltage ($V_{GE} = 0\text{V}$)	V_{CES}	4500	Volts
Gate-Emitter Voltage ($V_{CE} = 0\text{V}$)	V_{GES}	± 20	Volts
Collector Current, DC ($T_C = 91^\circ\text{C}$)	I_C	150	Amperes
Peak Collector Current (Pulse)	I_{CM}	300*	Amperes
Diode Forward Current**	I_F	150	Amperes
Diode Forward Surge Current** (Pulse)	I_{FM}	300*	Amperes
I^2t for Diode ($t = 10\text{ms}$)	I^2t	10	kA^2sec
Maximum Collector Dissipation ($T_C = 25^\circ\text{C}$, IGBT Part, $T_{j(max)} \leq 150^\circ\text{C}$)	P_C	1440	Watts
Mounting Torque, M6 Terminal Screws	—	44	in-lb
Mounting Torque, M6 Mounting Screws	—	44	in-lb
Module Weight (Typical)	—	900	Grams
Isolation Voltage (Charged Part to Baseplate, AC 60Hz 1 min.)	V_{iso}	9.0	kVolts
Partial Discharge	Q_{pd}	10	pC
(V1 = 4800 V_{RMS} , V2 = 3500 V_{RMS} , $f = 60\text{Hz}$ (Acc. to IEC 1287))			
Maximum Short-Circuit Pulse Width,	t_{psc}	10	μs
(VCC $\leq 3200\text{V}$, $V_{GE} = \pm 15\text{V}$, $R_{G(off)} \geq 60\Omega$, $T_j = 125^\circ\text{C}$)			

Electrical Characteristics, $T_j = 25\text{ }^\circ\text{C}$ unless otherwise specified

Characteristics	Symbol	Test Conditions	Min.	Typ.	Max.	Units
Collector-Cutoff Current	I_{CES}	$V_{CE} = V_{CES}$, $V_{GE} = 0\text{V}$	—	—	2.7	mA
Gate Leakage Current	I_{GES}	$V_{GE} = V_{GES}$, $V_{CE} = 0\text{V}$	—	—	0.5	μA
Gate-Emitter Threshold Voltage	$V_{GE(th)}$	$I_C = 10\text{mA}$, $V_{CE} = 10\text{V}$	4.5	6.0	7.5	Volts
Collector-Emitter Saturation Voltage	$V_{CE(sat)}$	$I_C = 150\text{A}$, $V_{GE} = 15\text{V}$, $T_j = 25^\circ\text{C}$	—	3.5	3.9***	Volts
		$I_C = 150\text{A}$, $V_{GE} = 15\text{V}$, $T_j = 125^\circ\text{C}$	—	4.0	—	Volts
Total Gate Charge	Q_G	$V_{CC} = 2250\text{V}$, $I_C = 150\text{A}$, $V_{GE} = 15\text{V}$	—	1.4	—	μC
Emitter-Collector Voltage**	V_{EC}	$I_E = 150\text{A}$, $V_{GE} = 0\text{V}$	—	4.7	5.6	Volts

* Pulse width and repetition rate should be such that device junction temperature (T_j) does not exceed $T_{j(max)}$ rating.

**Represents characteristics of the anti-parallel, emitter-to-collector free-wheel diode (FWDi).

*** Pulse width and repetition rate should be such that device junction temperature rise is negligible.

QID4515001
Dual IGBTMOD™ HVIGBT Module
 150 Amperes/4500 Volts

Electrical Characteristics, $T_j = 25\text{ }^\circ\text{C}$ unless otherwise specified

Characteristics	Symbol	Test Conditions	Min.	Typ.	Max.	Units
Input Capacitance	C_{ies}		—	18	—	nF
Output Capacitance	C_{oes}	$V_{GE} = 0V, V_{CE} = 10V$	—	1.33	—	nF
Reverse Transfer Capacitance	C_{res}		—	0.4	—	nF
Resistive	Turn-on Delay Time	$V_{CC} = 2250V, I_C = 150A,$ $V_{GE} = \pm 15V,$	—	—	1.5	μs
Load	Rise Time					
Switching	Turn-off Delay Time	$R_G = 60\Omega, L_S = 180nH$ Inductive Load	—	—	3.5	μs
Times	Fall Time					
Turn-on Switching Energy	E_{on}	$T_j = 125^\circ\text{C}, I_C = 150A, V_{GE} = \pm 15V,$	—	600	—	mJ/P
Turn-off Switching Energy	E_{off}	$R_G = 60\Omega, V_{CC} = 2250V,$ $L_S = 180nH, \text{ Inductive Load}$	—	450	—	mJ/P
Diode Reverse Recovery Time**	t_{rr}	$V_{CC} = 2250V, I_E = 150A,$	—	—	1.8	μs
Diode Reverse Recovery Charge**	Q_{rr}	$V_{GE} = \pm 15V, R_{G(on)} = 60\Omega,$	—	81*	—	μC
Diode Reverse Recovery Energy	E_{rec}	$L_S = 180nH, \text{ Inductive Load}$	—	55	—	mJ/P
Stray Inductance (C1-E2)	L_{SCE}		—	60	—	nH
Lead Resistance Terminal-Chip	R_{CE}		—	0.8	—	m Ω

Thermal and Mechanical Characteristics, $T_j = 25\text{ }^\circ\text{C}$ unless otherwise specified

Characteristics	Symbol	Test Conditions	Min.	Typ.	Max.	Units
Thermal Resistance, Junction to Case***	$R_{th(j-c)} Q$	Per IGBT	—	—	0.087	$^\circ\text{C/W}$
Thermal Resistance, Junction to Case***	$R_{th(j-c)} D$	Per FWDi	—	—	0.174	$^\circ\text{C/W}$
Contact Thermal Resistance, Case to Fin	$R_{th(c-f)}$	Per Module, Thermal Grease Applied, $\lambda_{grease} = 1W/mK$	—	0.018	—	$^\circ\text{C/W}$
Comparative Tracking Index	CTI		600	—	—	
Clearance Distance in Air (Terminal to Base)	$d_{a(t-b)}$		35.0	—	—	mm
Creepage Distance Along Surface (Terminal to Base)	$d_{s(t-b)}$		64	—	—	mm
Clearance Distance in Air (Terminal to Terminal)	$d_{a(t-t)}$		19	—	—	mm
Creepage Distance Along Surface (Terminal to Terminal)	$d_{s(t-t)}$		54	—	—	mm

*Pulse width and repetition rate should be such that device junction temperature rise is negligible.
 **Represents characteristics of the anti-parallel, emitter-to-collector free-wheel diode (FWDi).
 *** T_C measurement point is just under the chips.



QID4515001
Dual IGBTMOD™ HVIGBT Module
 150 Amperes/4500 Volts

COLLECTOR-EMITTER SATURATION VOLTAGE CHARACTERISTICS (TYPICAL)

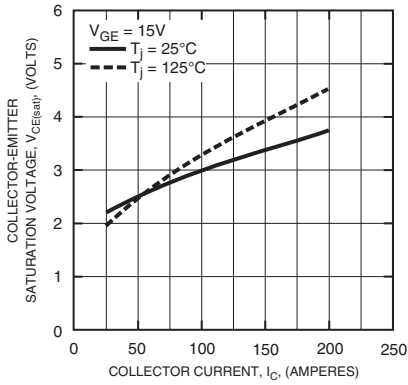

FREE-WHEEL DIODE FORWARD CHARACTERISTICS (TYPICAL)

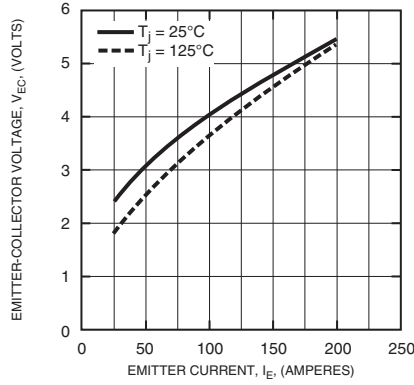

TRANSIENT THERMAL IMPEDANCE CHARACTERISTICS (IGBT)

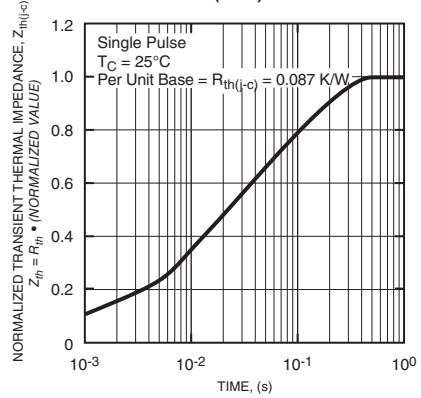

TRANSIENT THERMAL IMPEDANCE CHARACTERISTICS (FWD)

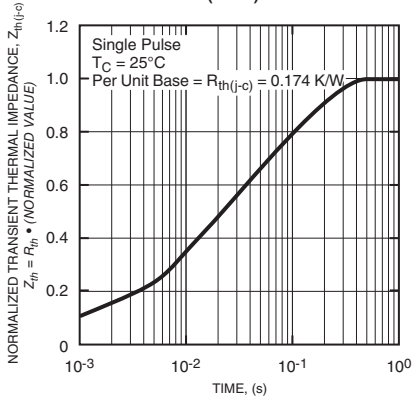

HALF-BRIDGE TURN-ON SWITCHING ENERGY CHARACTERISTICS (TYPICAL)

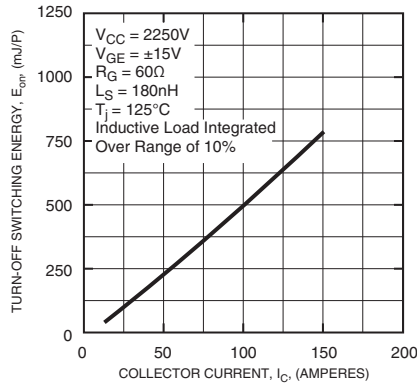

HALF-BRIDGE TURN-OFF SWITCHING ENERGY CHARACTERISTICS (TYPICAL)

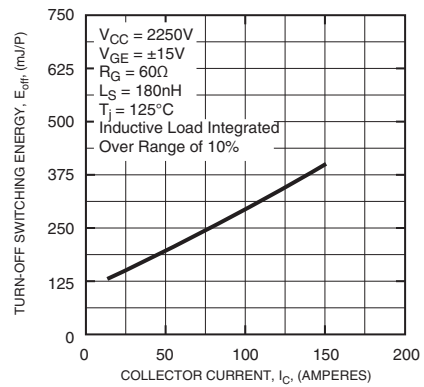

FREE-WHEEL DIODE REVERSE RECOVERY CHARACTERISTICS (TYPICAL)

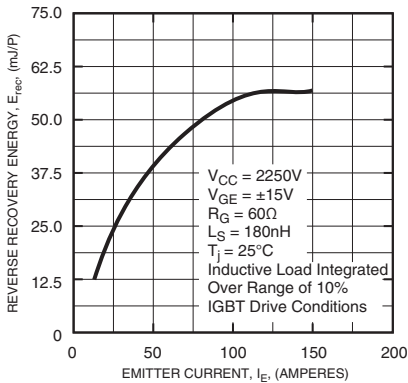

TURN-OFF SWITCHING SAFE OPERATING AREA (RBSOA) (TYPICAL)

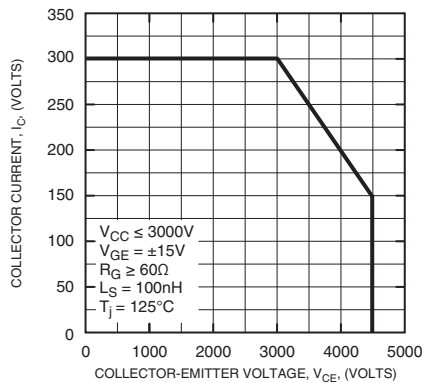

DIODE REVERSE RECOVERY SAFE OPERATING AREA (TYPICAL)

