



SANYO Semiconductors

## DATA SHEET

LA6324N

Monolithic Linear IC

~~LA6324NM~~

High-Performance

Quad Operational Amplifier

## Overview

The LA6324 consists of four independent, high-performance, internally phase compensated operational amplifiers that are designed to operate from a single power supply over a wide range of voltages. These four operational amplifiers are packaged in a single package. As in case of conventional general-purpose operational amplifiers, operation from dual power supplies is also possible and the power dissipation is low. It can be applied to various uses in commercial and industrial equipment including all types of transducer amplifiers and DC amplifiers.

## Features

- No phase compensation required
- Wide operating voltage range:  
3.0 V to 30.0 V (single supply)  
 $\pm 1.5$  V to  $\pm 15.0$  V (dual supplies)
- Highly resistant to dielectric breakdown
- Input voltage range includes the neighborhood of GND level and output voltage range  $V_{OUT}$  is from 0 to  $V_{CC} - 1.5$  V.
- Small current dissipation:

$$I_{CC} = 0.6 \text{ mA typ}/V_{CC} = +5 \text{ V}, R_L = \infty$$

## Specifications

Absolute Maximum Ratings at  $T_a = 25^\circ\text{C}$ 

Parameter	Symbol	Conditions	Ratings	Unit
Maximum Supply voltage	$V_{CC \text{ max}}$		32	V
Differential input voltage	$V_{ID}$		32	V
Maximum input voltage	$V_{IN \text{ max}}$		-0.3 to +32	V
Allowable power dissipation	$P_d \text{ max}$	LA6324N	720	mW
		<del>LA6324NM</del>	<del>330</del>	<del>mW</del>
Operating temperature	$T_{opr}$		-30 to +85	$^\circ\text{C}$
Storage temperature	$T_{stg}$		-55 to +125	$^\circ\text{C}$

■ Any and all SANYO Semiconductor products described or contained herein do not have specifications that can handle applications that require extremely high levels of reliability, such as life-support systems, aircraft's control systems, or other applications whose failure can be reasonably expected to result in serious physical and/or material damage. Consult with your SANYO Semiconductor representative nearest you before using any SANYO Semiconductor products described or contained herein in such applications.

■ SANYO Semiconductor assumes no responsibility for equipment failures that result from using products at values that exceed, even momentarily, rated values (such as maximum ratings, operating condition ranges, or other parameters) listed in products specifications of any and all SANYO Semiconductor products described or contained herein.

SANYO Semiconductor Co., Ltd.

TOKYO OFFICE Tokyo Bldg., 1-10, 1 Chome, Ueno, Taito-ku, TOKYO, 110-8534 JAPAN

# LA6324N, 6324NM

Operating Characteristics at  $T_a = 25\text{ }^\circ\text{C}$ ,  $V_{CC} = +5\text{ V}$

Parameter	Symbol	Conditions	Test circuit	Ratings			Unit
				min	typ	max	
Input offset voltage	$V_{IO}$		1		$\pm 2$	$\pm 7$	mV
Input offset current	$I_{IO}$	$I_{IN(+)} / I_{IN(-)}$	2		$\pm 5$	$\pm 50$	nA
Input bias current	$I_B$	$I_{IN(+)} / I_{IN(-)}$	3		45	250	nA
Common-mode input voltage range	$V_{ICM}$		4	0		$V_{CC} - 1.5$	V
Common-mode rejection ratio	CMR		4	65	80		dB
Voltage gain	VG	$V_{CC} = 15\text{ V}$ , $R_L \geq 2\text{ k}\Omega$	5	25	100		V/mV
Output voltage range	$V_{OUT}$			0		$V_{CC} - 1.5$	V
Supply voltage rejection ratio	SVR		6	65	100		dB
Channel separation	CS	$f = 1\text{ k}$ to $20\text{ kHz}$	7		120		dB
Current drain	$I_{CC}$		8		0.6	2	mA
	$I_{CC}$	$V_{CC} = 30\text{ V}$	8		1.5	3	mA
Output current (Source)	$I_{O\text{ source}}$	$V_{IN+} = 1\text{ V}$ , $V_{IN-} = 0\text{ V}$	9	20	40		mA
Output current (Sink)	$I_{O\text{ sink}}$	$V_{IN+} = 0\text{ V}$ , $V_{IN-} = 1\text{ V}$	10	10	20		mA

## Package Dimensions

unit : mm

3003B [LA6324N]

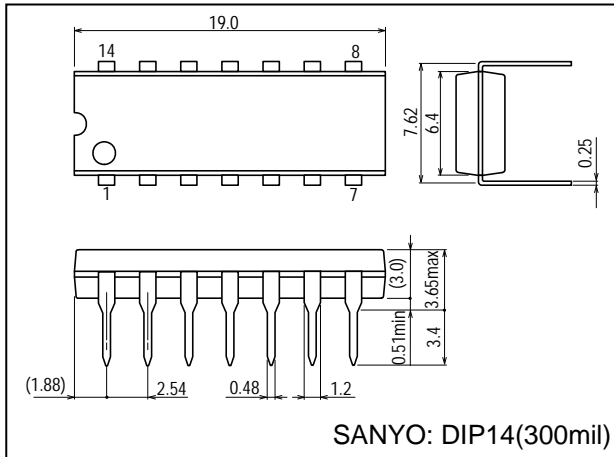

unit : mm

3034B [LA6324NM]

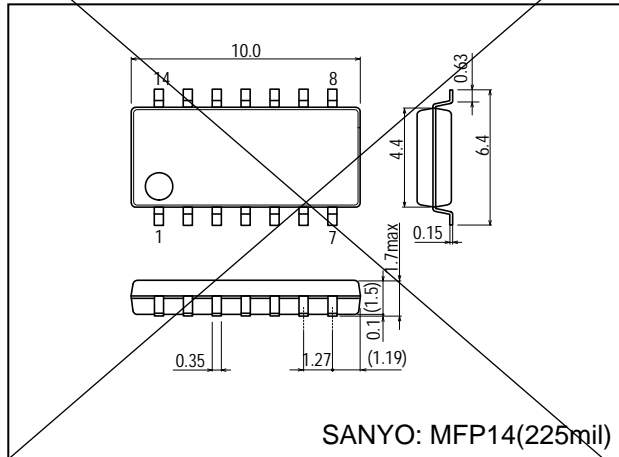

## Equivalent Circuit

(1 unit)

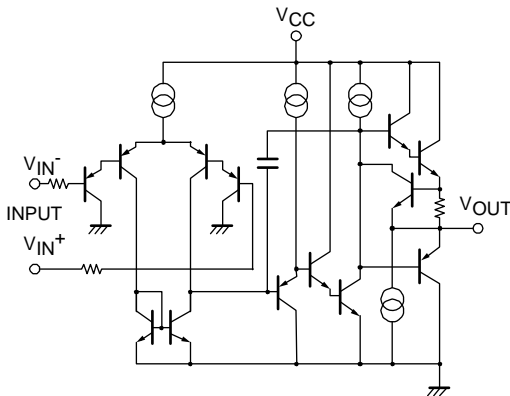

## Pin Assignment

(LA6324N, 6324NM)

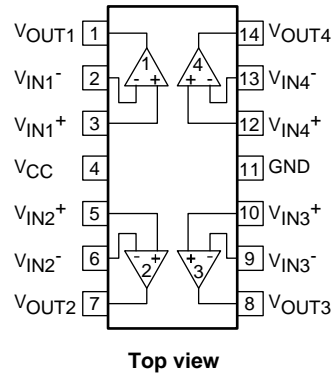

**Test Circuit**

1. Input offset voltage  $V_{IO}$

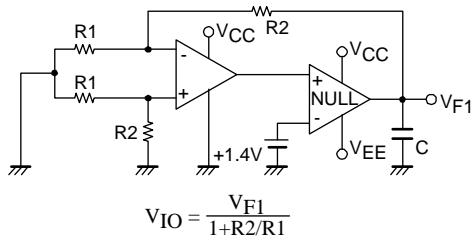

2. Input offset current  $I_{IO}$

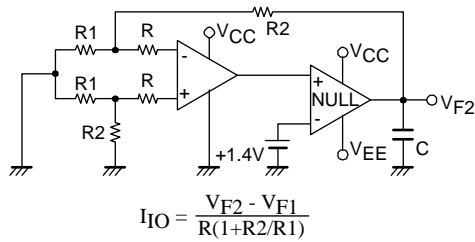

3. Input bias current  $I_B$

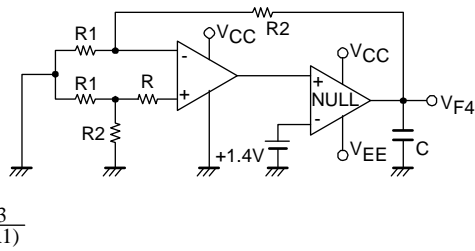
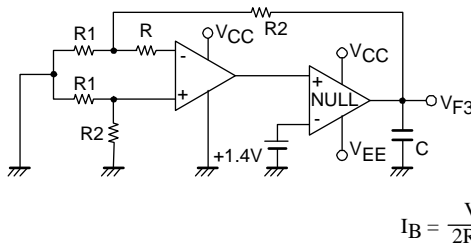

4. Common-mode rejection ratio CMR  
Common-mode input voltage range  $V_{ICM}$

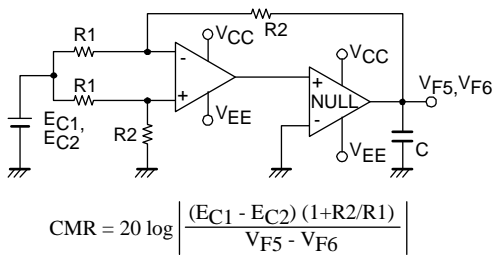

5. Voltage gain  $V_G$

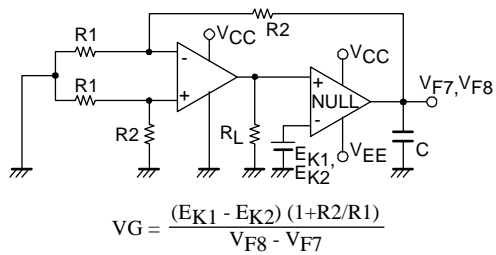

6. Supply voltage rejection ratio SVR

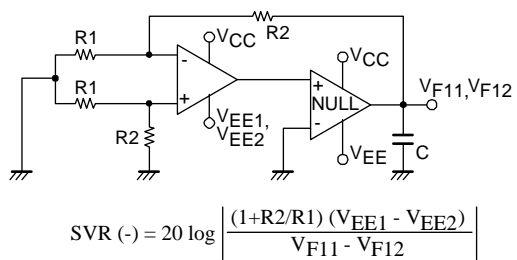
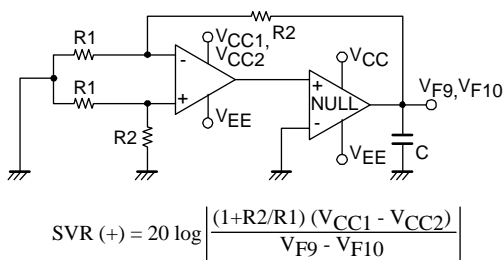

7. Channel separation CS

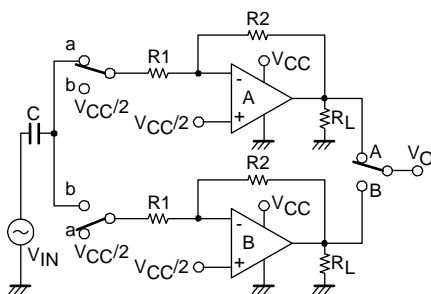

SW: a  
CS (A→B) =  $20 \log \frac{R2 V_{OA}}{R1 V_{OB}}$

SW: b  
CS (B→A) =  $20 \log \frac{R2 V_{OB}}{R1 V_{OA}}$

These apply also to other channels.

# LA6324N, 6324NM

## 8. Current drain $I_{CC}$

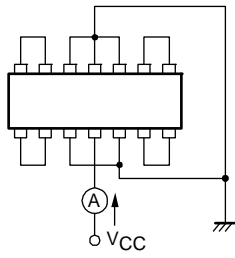

## 9. Output current $I_O$ source

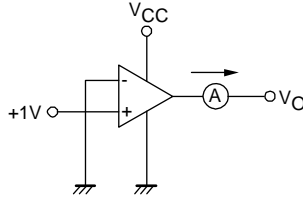

## 10. Output current $I_O$ sink

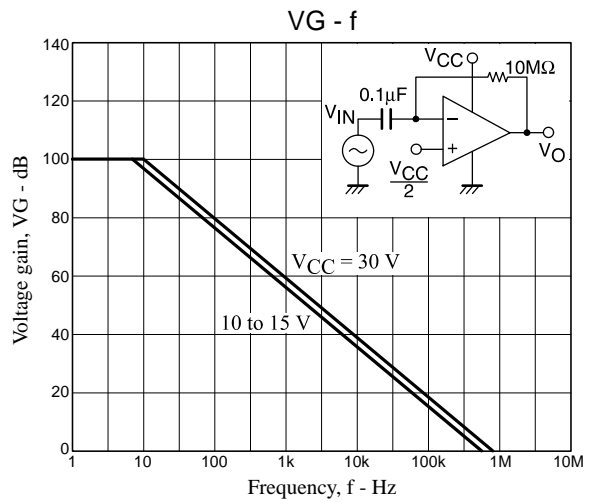
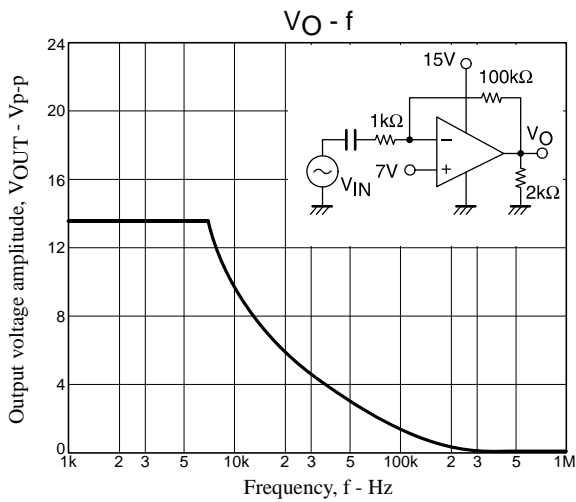
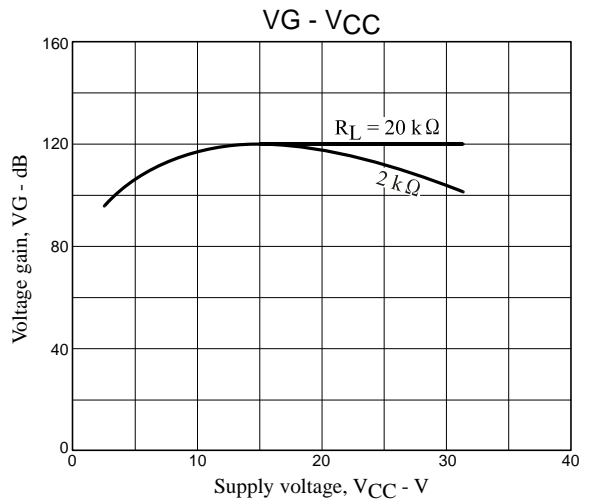
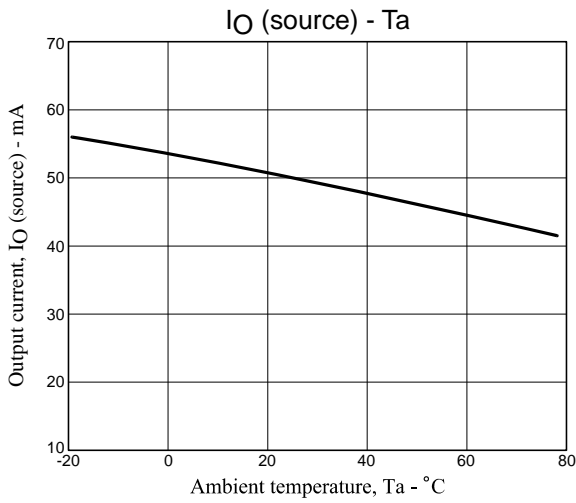
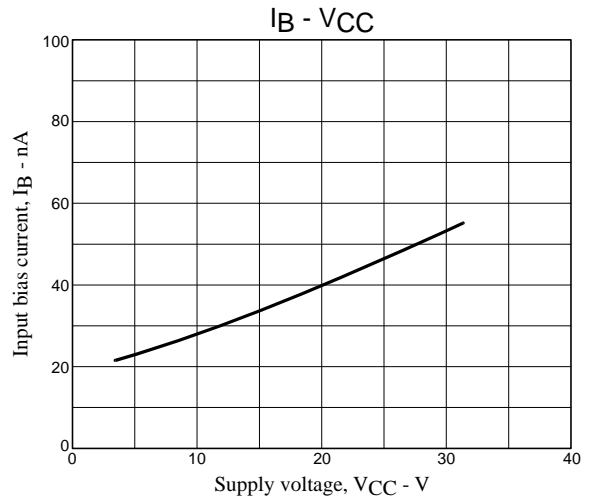
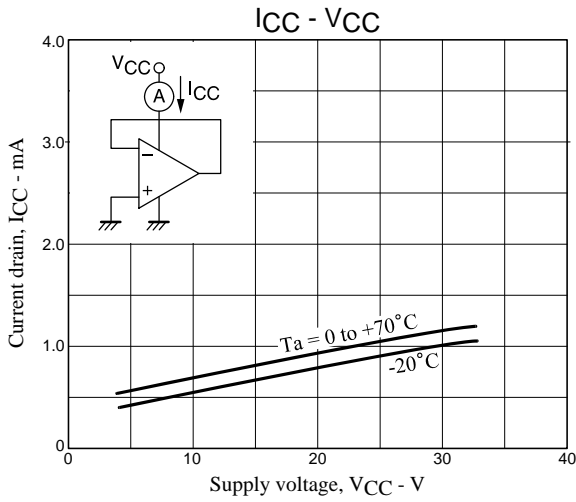
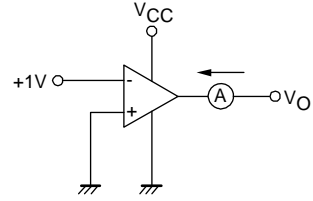

# LA6324N,6324NM

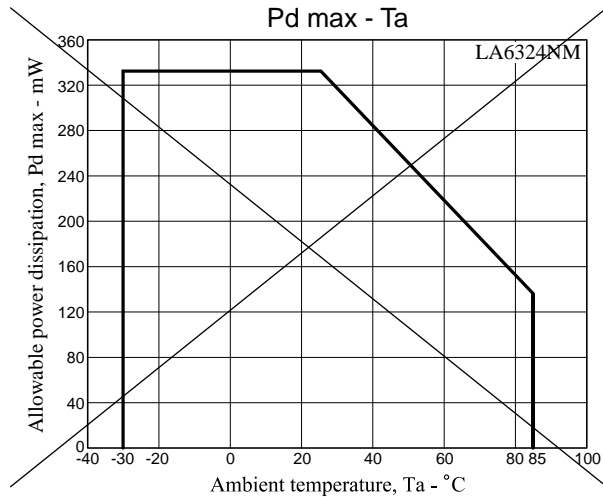
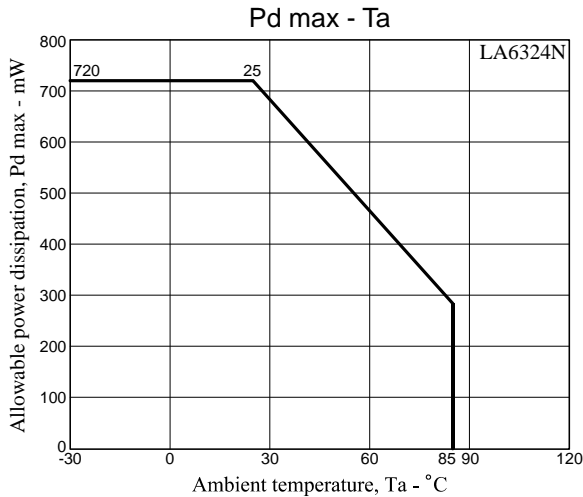

## Sample Application Circuits

Noninverting DC amplifier

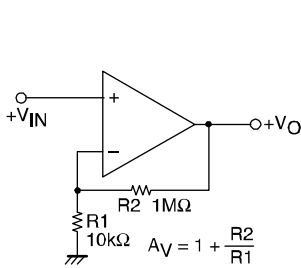

Rectangular wave oscillator

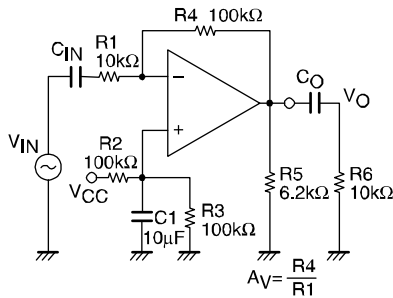

Inverting AC amplifier

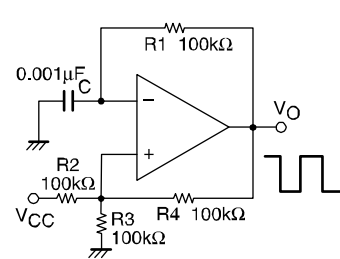

- Specifications of any and all SANYO Semiconductor products described or contained herein stipulate the performance, characteristics, and functions of the described products in the independent state, and are not guarantees of the performance, characteristics, and functions of the described products as mounted in the customer's products or equipment. To verify symptoms and states that cannot be evaluated in an independent device, the customer should always evaluate and test devices mounted in the customer's products or equipment.
- SANYO Semiconductor Co., Ltd. strives to supply high-quality high-reliability products. However, any and all semiconductor products fail with some probability. It is possible that these probabilistic failures could give rise to accidents or events that could endanger human lives, that could give rise to smoke or fire, or that could cause damage to other property. When designing equipment, adopt safety measures so that these kinds of accidents or events cannot occur. Such measures include but are not limited to protective circuits and error prevention circuits for safe design, redundant design, and structural design.
- In the event that any or all SANYO Semiconductor products (including technical data, services) described or contained herein are controlled under any of applicable local export control laws and regulations, such products must not be exported without obtaining the export license from the authorities concerned in accordance with the above law.
- No part of this publication may be reproduced or transmitted in any form or by any means, electronic or mechanical, including photocopying and recording, or any information storage or retrieval system, or otherwise, without the prior written permission of SANYO Semiconductor Co., Ltd.
- Any and all information described or contained herein are subject to change without notice due to product/technology improvement, etc. When designing equipment, refer to the "Delivery Specification" for the SANYO Semiconductor product that you intend to use.
- Information (including circuit diagrams and circuit parameters) herein is for example only; it is not guaranteed for volume production. SANYO Semiconductor believes information herein is accurate and reliable, but no guarantees are made or implied regarding its use or any infringements of intellectual property rights or other rights of third parties.

This catalog provides information as of October, 2004. Specifications and information herein are subject to change without notice.