

## **AKCM6432T**

**512KB SECONDARY CACHE MODULE  
FOR THE PENTIUM CPU AND 82430 PCISSETS**

### **FEATURES**

- 64K x 64 Configuration
- 16K x 11 Tag SRAM Field
- Low profile card edge module with 160 leads
- Separate 5V and 3.3V power supplies
- Multiple GND pins and decoupling capacitors for maximum noise immunity.
- Synchronous SRAM with Burst Counter

### **DESCRIPTION**

The AKCM6432T Module uses four 32K x 32 pipelined burst RAMs in surface mount packages mounted on a multi-layer FR4 board. In addition, it uses two 5V 8-bit wide SRAMs to achieve an eleven bit tag field. Four PD (presence detect) input pins allow the system to determine the particular cache configuration. The low profile card edge package allows 160 single leads to be placed on a package 4.35" long, a maximum of 0.350" thick and a maximum of 1.14" tall. All inputs and outputs are TLL-compatible, and operate from separate 5V (+/- 5%) and 3.3V (+10/-5%) power supplies. Multiple GND pins and on-board decoupling capacitors ensure maximum protection from noise.

ACCUTEK

# PINOUT - TOP VIEW

GND	81	1	GND
TIO1	82	2	TIO0
TIO7	83	3	TIO2
TIO5	84	4	TIO6
TIO3	85	5	TIO4
TIO9	86	6	TIO8
VCC5	87	7	NC
TIO10	88	8	TWE
CADV	89	9	CADSC
GND	90	10	GND
COE	91	11	CWE4
CWE5	92	12	CWE6
CWE7	93	13	CWE0
CWE1	94	14	CWE2
VCC5	95	15	VCC3
CWE3	96	16	CS
NC	97	17	GW
NC	98	18	BWE
GND	99	19	GND
NC	100	20	A3
A4	101	21	A7
A6	102	22	A5
A8	103	23	A11
A10	104	24	A16
NC	105	25	VCC3
A17	106	26	A18
GND	107	27	GND
A9	108	28	A12
A14	109	29	A13
A15	110	30	CADSP
NC	111	31	NC
PD0	112	32	NC
PD2	113	33	PD1
LBO	114	34	PD3
GND	115	35	GND
CLK0	116	36	CLK1
GND	117	37	GND
D63	118	38	D62
NC	119	39	VCC3
D61	120	40	D60
D59	121	41	D58
D57	122	42	D56
GND	123	43	GND
D55	124	44	D54
D53	125	45	D52
D51	126	46	D50
D49	127	47	D48
GND	128	48	GND
D47	129	49	D46
D45	130	50	D44
D43	131	51	D42
NC	132	52	VCC3
D41	133	53	D40
D39	134	54	D38
D37	135	55	D36
GND	136	56	GND
D35	137	57	D34
D33	138	58	D32
D31	139	59	D30
NC	140	60	VCC3
D29	141	61	D28
D27	142	62	D26
D25	143	63	D24
GND	144	64	GND
D23	145	65	D22
D21	146	66	D20
D19	147	67	D18
NC	148	68	VCC3
D17	149	69	D16
D15	150	70	D14
D13	151	71	D12
GND	152	72	GND
D11	153	73	D10
D9	154	74	D8
D7	155	75	D6
NC	156	76	VCC3
D5	157	77	D4
D3	158	78	D2
D1	159	79	D0
GND	160	80	GND

**PIN NAMES**

A5 - A18	Address Inputs
A3 - A4	Address Inputs (Burst SRAMs only)
D0 - D63	Cache Data Inputs/Outputs
TIO0 - TIO10	Tag Inputs/Outputs
OE#	Cache Data Output Enabled Input
TWE#	Tag Write Enable Input
WE#0 - WE#7	Cache Data Write Enable Inputs
CS#	Cache Data Chip Enable Input (Burst only)
CADSc#	Cache Address Status Input (Burst SRAMs only)
CADSp#	Processor Address Status Input (Burst only)
CADV#	Burst Address Advance (Burst SRAMs only)
GW#	Global Write Input (Burst SRAMs only)
BWE#	Byte Write Enable Input (Burst SRAMs only)
LBO#	Linear Burst Order
CLK0 - CLK1	Clock Inputs (Burst SRAMs only)
PD0 - PD4	Presence Detect Pins
NC	No Connect
GND	Ground
Vcc5	5 Volt Power Supply
Vcc3	3.3 Volt Power Supply

**PRESENCE DETECT TABLE**

PD4	PD3	PD2	PD1	PD0	Module
NC	NC	NC	NC	NC	No Cache Present
GND	GND	NC	GND	GND	512KB Pipelined Burst

## RECOMMENDED DC OPERATING CONDITIONS

Symbol	Parameter	Min.	Typ.	Max.	Unit
Vcc3	Supply Voltage	3.146	3.3	3.6	V
Vcc5	Supply Voltage	4.75	5	5.25	V
GND	Supply Voltage	0	0	0	V
V <sub>IH</sub>	Input High Voltage	2.2	-	V <sub>cc</sub> + 0.3	V
V <sub>IL</sub>	Input Low Voltage	-0.5(1)	-	0.8	V

### NOTE:

1. V<sub>IL</sub> = -1.0V for pulse width less than 5ns, once per cycle

## RECOMMENDED OPERATING TEMPERATURE AND SUPPLY VOLTAGE

Power Plane	Ambient Temperature	GND	VCC
Vcc3	0°C to +70°C	0V	3.3V +10/-5%
Vcc5	0°C to +70°C	0V	5.0V +/- 5%

## ABSOLUTE MAXIMUM RATINGS

Symbol	Rating	Value	Unit
V <sub>TERM</sub>	Terminal Voltage with Respect to GND	-0.5 to V <sub>cc</sub> + 0.5	V
V <sub>TERM</sub> for Vcc3	Terminal Voltage with Respect to GND (Vcc terminals only)	-0.5 to +4.6	V
T <sub>A</sub>	Operating Temperature	0 to +70	°C
T <sub>BIAS</sub>	Temperature Under Bias	-10 to +85	°C
T <sub>STG</sub>	Storage Temperature	-55 to +125	°C
I <sub>OUT</sub>	DC Output Current	50	mA

## SRAM ACCESS TIMES

Module Speed	Asych	Burst <sup>(1)</sup>	Tag
66MHz	15nS	8.0nS	15nS

### NOTE:

1. Burst SRAMS are measured by Clock to Data Out (t<sub>cd</sub>)

## CAPACITANCE<sup>(1,2)</sup>

(T<sub>A</sub> = +25°C, f = 1.0 MHz)

Symbol	Parameter(1)	Condition	Value	Unit
C <sub>IN1</sub>	Input Capacitance (Address)	V <sub>IN</sub> = 0V	30	pF
C <sub>IN3</sub>	Input Capacitance (OE#)	V <sub>IN</sub> = 0V	25	pF
C <sub>IN4</sub>	Input Capacitance (WE#, TWE#)	V <sub>IN</sub> = 0V	8	pF
C <sub>I/O</sub>	I/O Capacitance	V <sub>OUT</sub> = 0V	20	pF

### NOTES:

1. These parameters are guaranteed by design but not tested
2. These parameters are maximum values

## DC ELECTRICAL CHARACTERISTICS

(Vcc5 = 5.0v +/- 5%, Vcc = 3.3V + 10/-5%, TA = 0°C TO 70°C)

Symbol	Parameter	Test Condition	Min.	Max.	Unit
ILI	Input Leakage Current (Address)	Vcc = Max, VIN = GND to Vcc	-	50	μA
ILI	Input Leakage Current (Data and Control)	Vcc = Max, VIN = GND to Vcc	-	20	μA
ILO	Output Leakage Current	VOUT = 0V to Vcc, Vcc = Max	-	20	μA
VOL	Output Low Voltage	IOL = 8mA, Vcc = Min	-	0.4	V
VOH	Output High Voltage	IOH = -4mA, Vcc = Min	2.4	-	V
ICC3	Operating 3.3V Power Supply Current	Vcc3 = Max, CE = VIL f = fMAX, Outputs Open	-	620	mA
ICC5	Operating 5V Power Supply Current	Vcc5 = Max, CE = VIL f = fMAX, Outputs Open	-	180	mA
ISB3	Standby 3.3V Power Supply Current	Vcc3 = Max, CE = VIH f = fMAX, Outputs Open	-	120	mA
ISB31	Full Standby 3.3V Power Supply Current	Vcc3 = Max, CE = Vcc - 0.2V, f = 0, VIN = 0.2V or VIN = Vcc - 0.2V, Outputs Open	-	60	mA

LBO

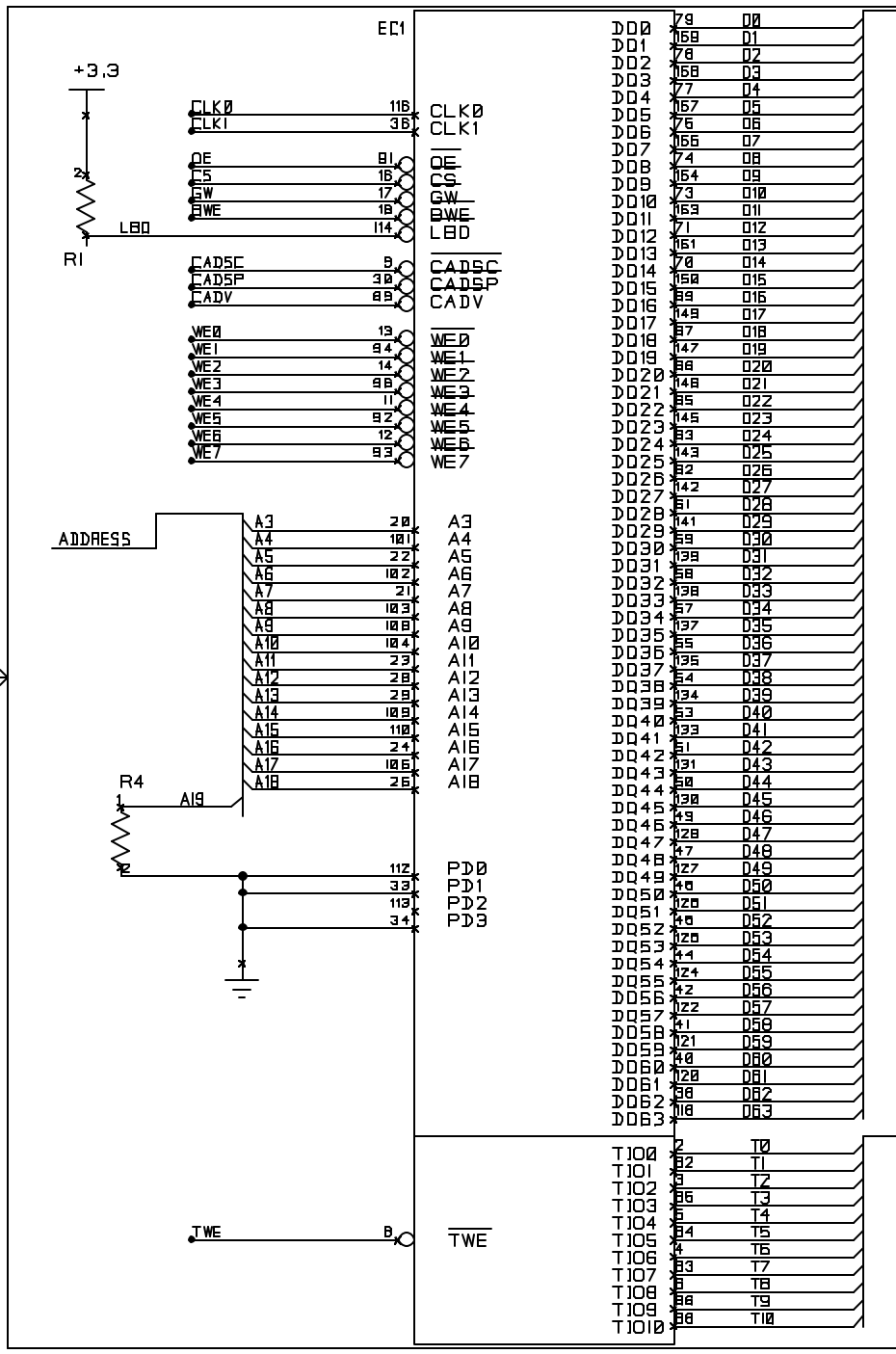

DATA

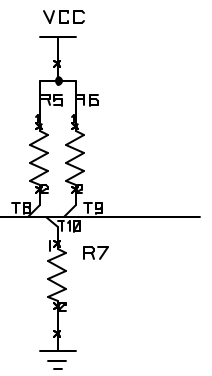
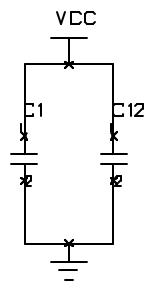
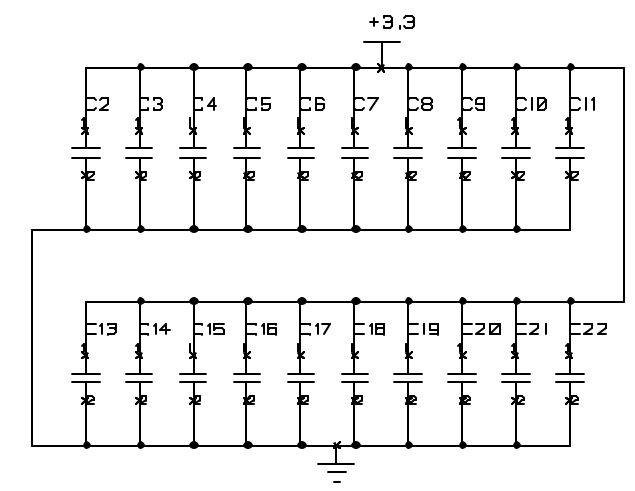

TAG

CONTRACT NO.		COMPANY NAME ACCUTEK MICROCIRCUIT CORP			
APPROVALS	DATE	DWG AKCM6432T PINOUT			
DRAWN		SIZE	FSCM NO.	DWG NO.	REV.
CHECKED		A			
ISSUED		SCALE		SHEET 1 of 3	

A15

ADDRESS

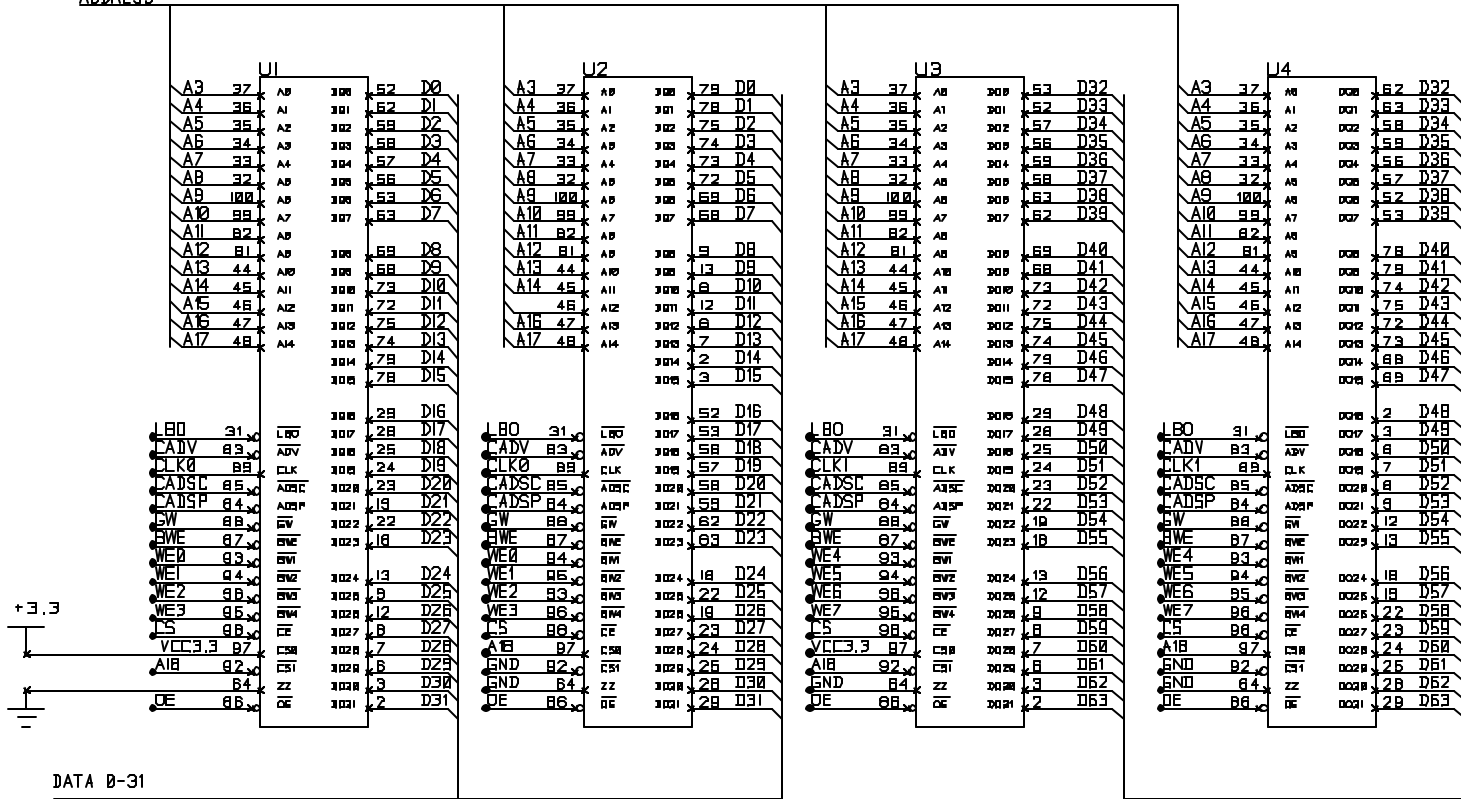

DATA 0-31

DATA 32-63

CONTRACT NO.		COMPANY NAME ACCUTEK MICROCIRCUIT CORP			
APPRDVALS	DATE	DWG AKCM6432T CACHE			
DRAWN		SIZE	FSCM NO.	DWG NO.	REV.
CHECKED		A			
ISSUED		SCALE		SHEET	

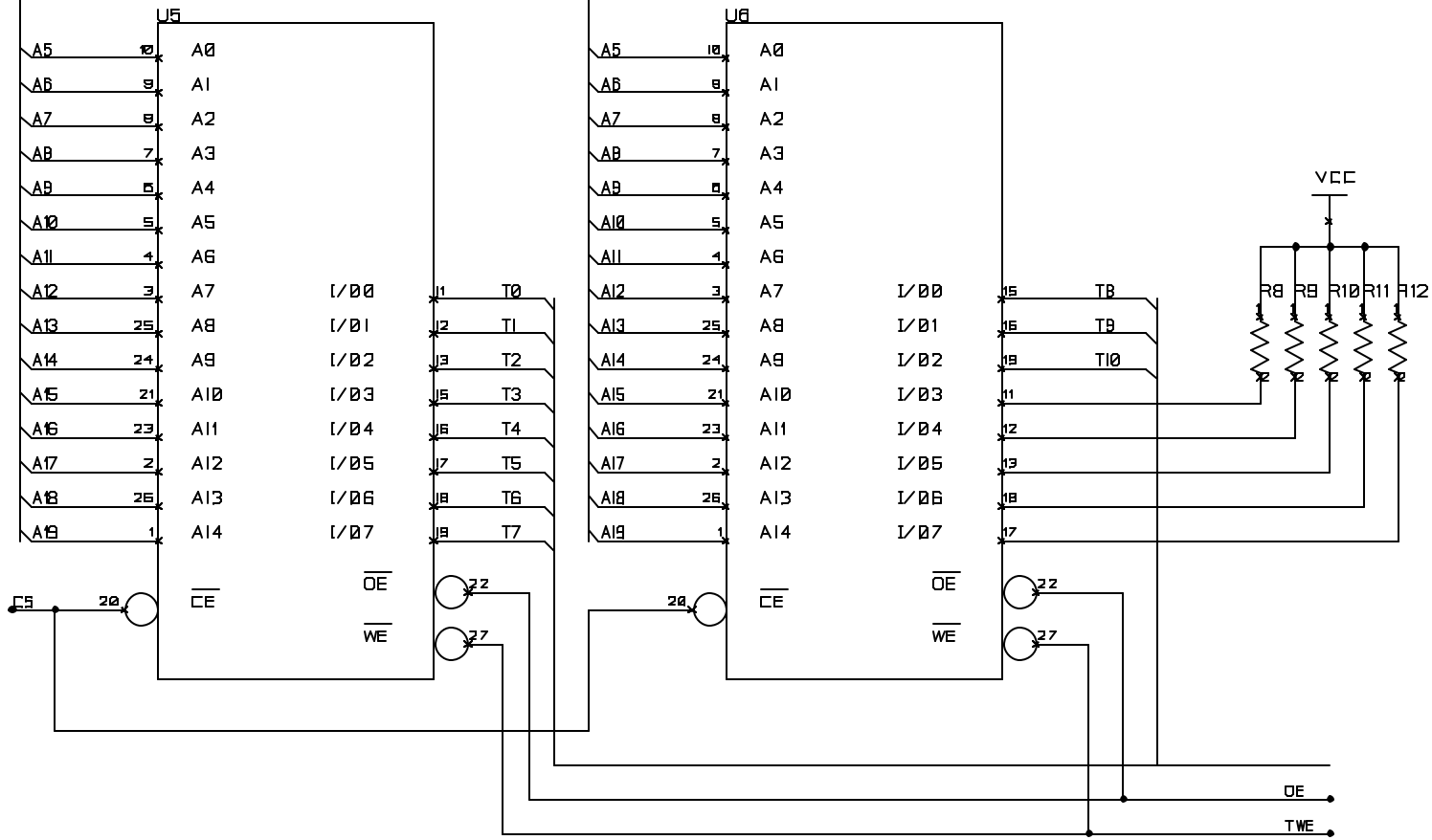

CONTRACT NO.		COMPANY NAME ACCUTEK MICROCIRCUIT CORP			
APPROVALS	DATE	DWG AKCM6432T TAG			
DRAWN		SIZE	FSCM NO.	DWG NO.	REV.
CHECKED		A			
ISSUED		SCALE		SHEET	



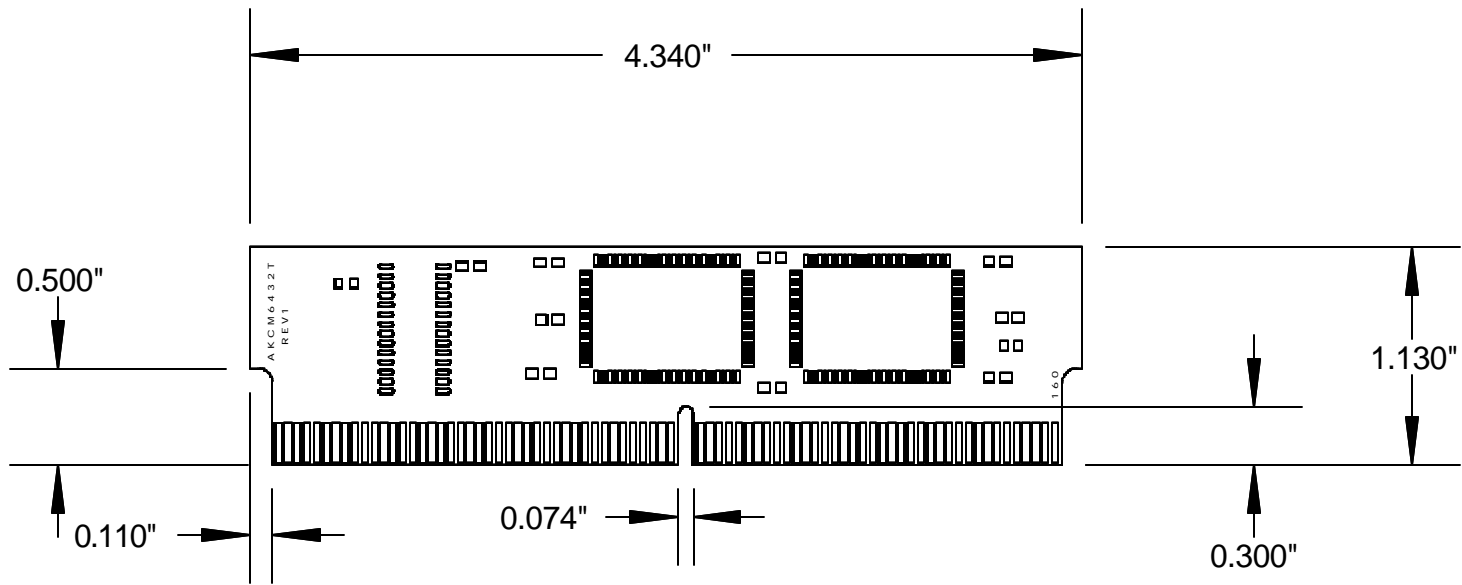

CONTRACT NO.		ACCUTEK MICROCIRCUIT CORP. NEWBURYPORT, MA 01950			
APPROVALS	DATE	DWG <b>COAST MODULE</b>			
DRAWN <b>GN</b>	<b>11/21/07</b>	SIZE <b>A</b>	FSCM NO.	DWG NO. <b>AKCM6432T</b>	REV. <b>1</b>
CHECKED		SCALE			SHEET <b>1 of 2</b>
ISSUED					