

## Internal Pull-up Hall Effect Latch

### ■ Features

- Bipolar Hall effect latch sensor
- 3.0V to 20V DC operation voltage
- Built-in pull-up resistor
- 25mA output sink current
- Operating temperature: -20°C to 85°C
- Package: SIP3, SOT23

### ■ Applications

- Rotor position sensing
- Current switch
- Encoder
- RPM detection

### ■ General Description

AH172 is a single digital output Hall-effect sensor with pull-up resistor for high temperature operation. The device includes an on-chip Hall voltage generator for magnetic sensing, an amplifier to amplify Hall voltage, and a comparator to provide switching hysteresis for noise rejection, and an output driver with a pull-up resistor (Rpu). An internal bandgap regulator is used to provide temperature compensated supply voltage for internal circuits and allows a wide operating supply range. While the magnetic flux density (B) is larger than operate point (Bop), the OUT pin turns on (low). If B removed toward release point (Brp), the OUT pin is latched “on” state prior to  $B < Brp$ . When  $B < Brp$ , the OUT pin go into “off” state.

### ■ Pin Assignments

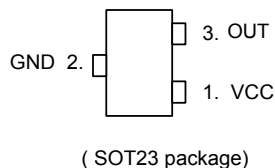
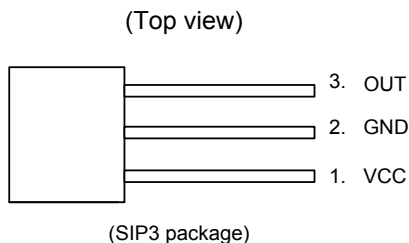

### ■ Pin Descriptions

Name	Description
VCC	Positive power supply
GND	Ground
OUT	Output stage

### ■ Ordering Information

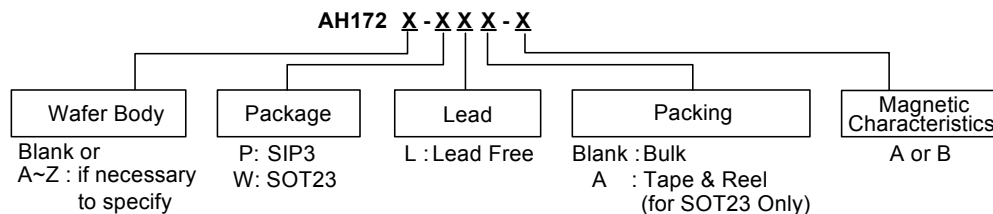

## Internal Pull-up Hall Effect Latch

### ■ Block Diagram

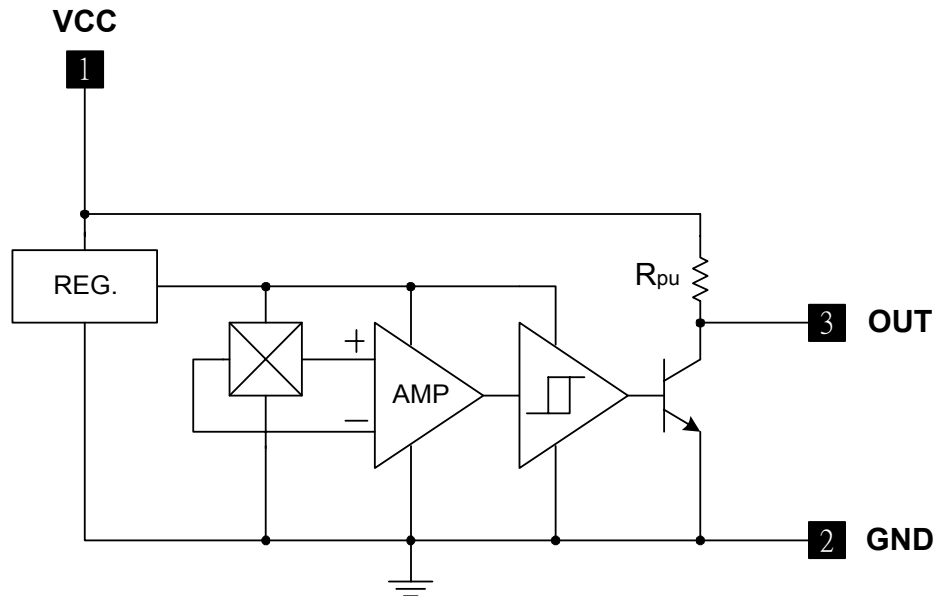

### ■ Functional Application Circuit

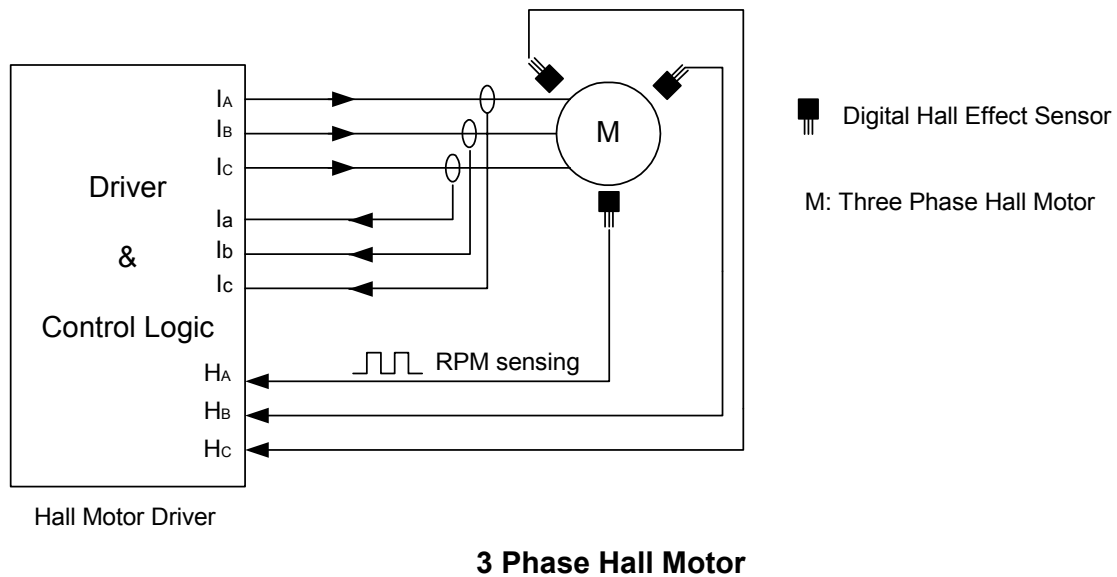

## Internal Pull-up Hall Effect Latch

### ■ Absolute Maximum Ratings ( at Ta= 25°C )

Characteristics	Symbol	Values	Unit
Supply Voltage	VCC	20	V
Output "off" Voltage	Vout (off)	20	V
Output "on" Current	Io (sink)	25	mA
Operating Temperature Range	Top	-20~+85	°C
Storage Temperature Range	Tstg	-65~+150	°C
Maximum Junction Temperature	Tj	+150	°C
Power Dissipation	SIP	550	mW
	SOT23	230	mW

### ■ Electrical Characteristics ( Ta= 25°C )

Characteristics	Symbol	Conditions	Min.	Typ.	Max.	Unit
Supply Voltage	Vcc		3	-	20	V
Output Saturation Voltage	Vout(sat)	VCC=12V, OUT "ON" Io =10mA	-	300	400	mV
Supply Current	Icc	VCC=12V, OUT "OFF"	-	3.5	6	mA
Internal Pull-up Resistor	Rpu		7	10	13	KΩ
Dropout Voltage	Vd	Vd = Vcc-Vce	-	-	0.3	V

### ■ Magnetic Characteristics (At Ta= 25°C )

(1mT = 10 Gauss)

#### A grade

Characteristics	Symbol	Min.	Typ.	Max.	Unit
Operate Point	Bop	15	-	60	Gauss
Release Point	Brp	-60	-	-15	Gauss
Hysteresis	Bhy	-	80	-	Gauss

#### B grade

Characteristics	Symbol	Min.	Typ.	Max.	Unit
Operate Point	Bop	5	-	80	Gauss
Release Point	Brp	-80	-	-5	Gauss
Hysteresis	Bhy	-	80	-	Gauss

### ■ Operating Characteristics

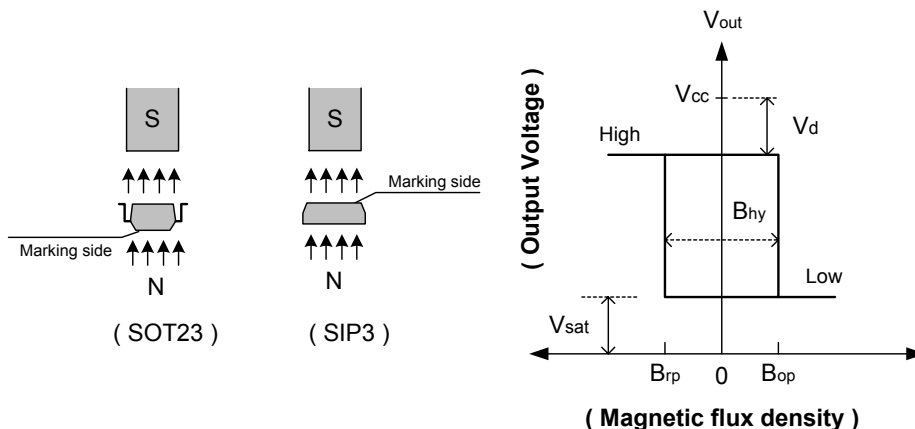

## Internal Pull-up Hall Effect Latch

### ■ Performance Characteristics (SIP3)

<b>Ta (°C)</b>	<b>25</b>	<b>50</b>	<b>60</b>	<b>70</b>	<b>80</b>	<b>85</b>	<b>90</b>	<b>95</b>	<b>100</b>
Pd (mW)	550	440	396	352	308	286	264	242	220
<b>Ta (°C)</b>	<b>105</b>	<b>110</b>	<b>115</b>	<b>120</b>	<b>125</b>	<b>130</b>	<b>135</b>	<b>140</b>	<b>150</b>
Pd (mW)	198	176	154	132	110	88	66	44	0

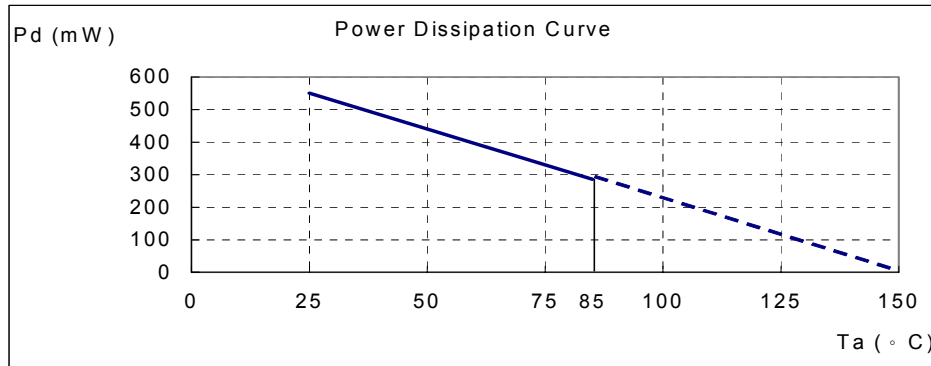

### ■ Performance Characteristics (SOT23-3)

<b>Ta (°C)</b>	<b>25</b>	<b>50</b>	<b>60</b>	<b>70</b>	<b>80</b>	<b>85</b>	<b>90</b>	<b>100</b>	<b>110</b>	<b>120</b>	<b>125</b>	<b>130</b>	<b>140</b>	<b>150</b>
Pd (mW)	230	184	166	147	129	120	110	92	74	55	46	37	18	0

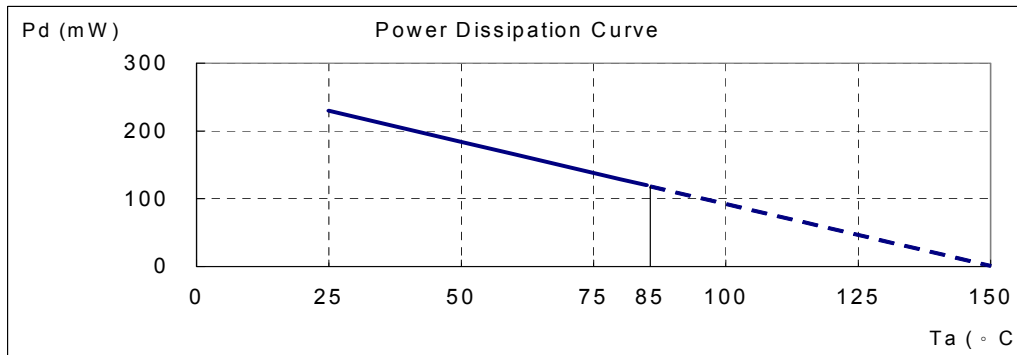

### ■ Marking Information

(1) SOT23

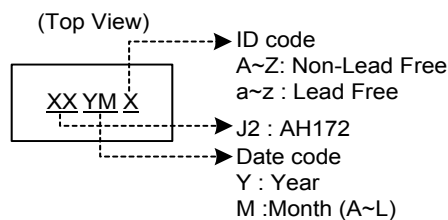

(2) SIP3

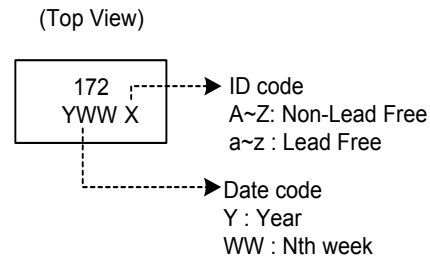

## Internal Pull-up Hall Effect Latch

### ■ Package Information

(1) Package Type: SIP-3L

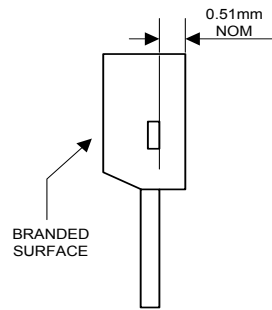

Active Area Depth

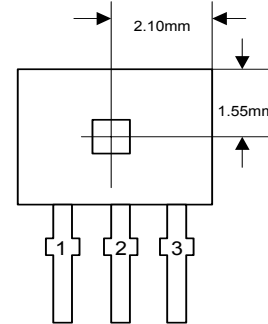

Sensor Location

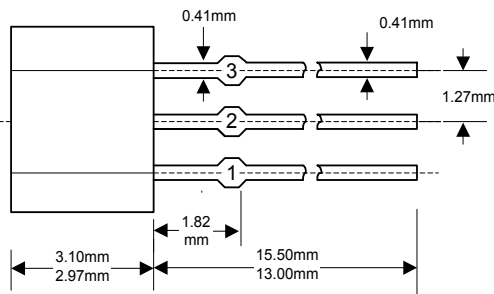
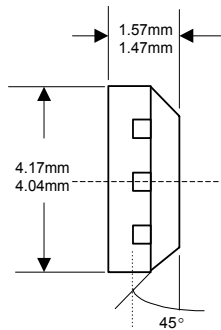
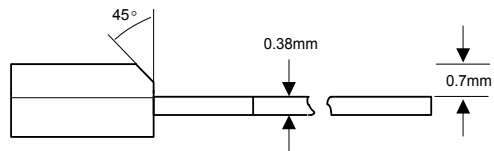

Package Dimension

## Internal Pull-up Hall Effect Latch

(2) Package Type: SOT23-3L

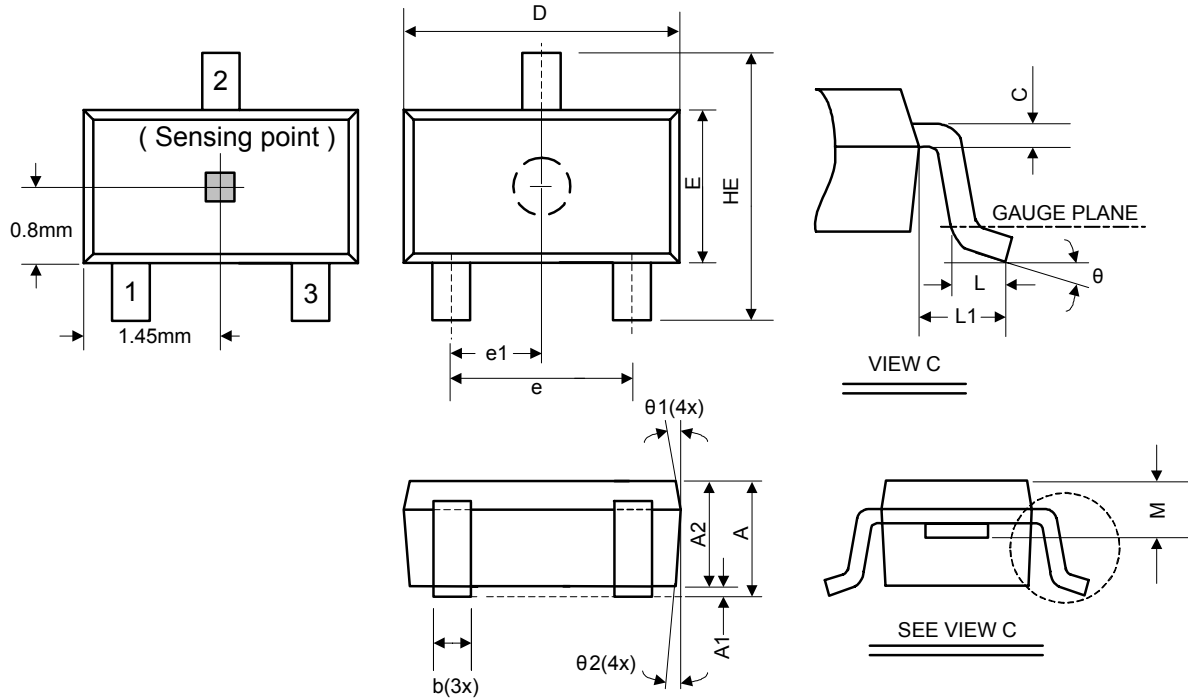

Symbol	Dimensions In Millimeters			Dimensions In Inches		
	Min.	Nom.	Max.	Min.	Nom.	Max.
A	1.05	-	1.35	0.041	-	0.053
A1	0.05	-	0.15	0.002	-	0.006
A2	1.00	1.10	1.20	0.039	0.043	0.047
b	0.25	-	0.50	0.010	-	0.020
C	0.08	-	0.20	0.003	-	0.008
D	2.70	2.90	3.00	0.106	0.114	0.118
E	1.50	1.60	1.70	0.059	0.063	0.067
HE	2.60	2.80	3.00	0.102	0.110	0.118
L	0.30	-	0.60	0.012	-	0.024
L1	0.50	0.60	0.70	0.020	0.024	0.028
M	0.73	0.78	0.83	0.029	0.031	0.033
e	1.80	1.90	2.00	0.071	0.075	0.079
e1	0.85	0.95	1.05	0.033	0.037	0.041
$\theta$	0°	5°	10°	0°	5°	10°
$\theta1$	3°	5°	7°	3°	5°	7°
$\theta2$	6°	8°	10°	6°	8°	10°