



Features

- Shielded construction
- Unit height of 5.6 mm
- Inductance range: 0.3 μ H to 7.2 μ H
- Current up to 18 A
- RoHS compliant*

Applications

- Input/output of DC/DC converters
- Power supplies for:
 - Portable communications equipment
 - Camcorders
 - LCD TVs
 - Car audio systems

SRP1205 Series - Shielded Power Inductors

Electrical Specifications

Bourns Part No.	Initial Inductance L0 (μ H)	Inductance at Flat Point L1 (μ H)	Flat Point ref. (A)	SRF typ. (MHz)	I rms (A)	I sat (A)	DCR (m Ω) max.
SRP1205-R30Y	0.54 \pm 25 %	0.30 \pm 25 %	5.00	160	18.0	35.0	1.8
SRP1205-R60Y	0.85 \pm 25 %	0.60 \pm 25 %	5.00	95	16.0	27.0	2.5
SRP1205-1R0Y	1.25 \pm 25 %	1.00 \pm 25 %	5.00	75	14.0	22.0	3.4
SRP1205-1R8Y	2.00 \pm 25 %	1.80 \pm 25 %	2.00	55	13.0	16.0	3.4
SRP1205-2R5Y	2.70 \pm 25 %	2.50 \pm 25 %	2.00	40	11.5	12.0	3.4
SRP1205-3R3Y	3.50 \pm 25 %	3.30 \pm 25 %	2.00	40	11.0	11.8	5.4
SRP1205-4R0Y	4.20 \pm 25 %	4.00 \pm 25 %	3.00	35	10.5	8.3	5.4
SRP1205-5R6Y	5.80 \pm 25 %	5.60 \pm 25 %	2.00	30	8.5	8.0	11.4
SRP1205-7R2Y	7.40 \pm 25 %	7.20 \pm 25 %	2.00	30	8.3	7.5	13.5

General Specifications

Test Voltage.....1 V
 Test Frequency100 KHz
 Reflow Soldering.....230 °C; 50 sec max.
 Operating Temperature ..-55 °C to +150 °C
 (Temperature rise included)
 Storage Temperature...-55 °C to +150 °C
 Resistance to Soldering Heat
+260 °C for 10 sec.

Materials

Core.....Ferrite ER
 Wire.....Enameled copper
 Terminal.....Cu/Ni/Sn
 Rated Current.....Ind. drops 20 % at I sat
 Temperature Rise.....40 °C at rated I rms
 Packaging600 pcs. per 13-inch reel

L vs I Charts

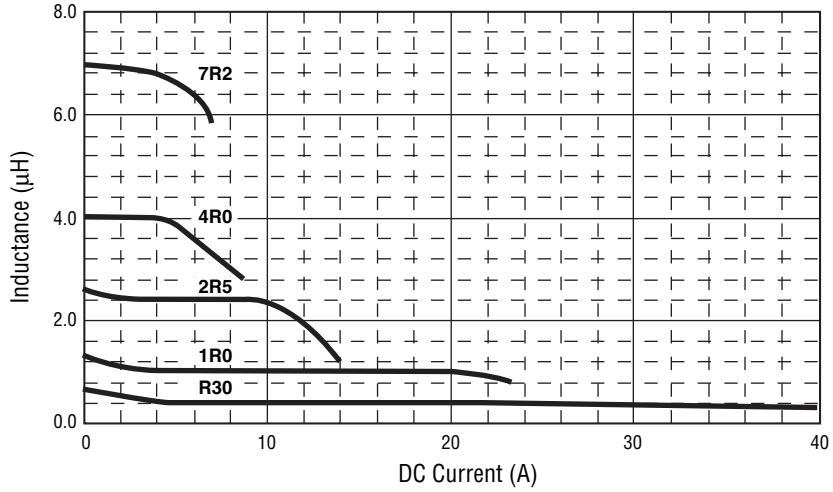

Product Dimensions

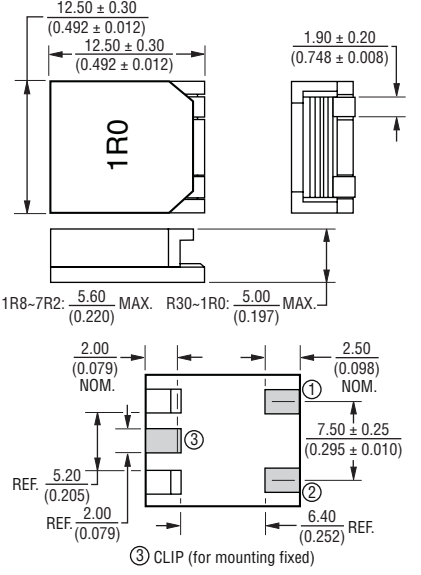

Electrical Schematic

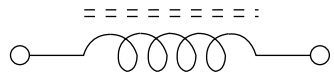

Recommended Layout

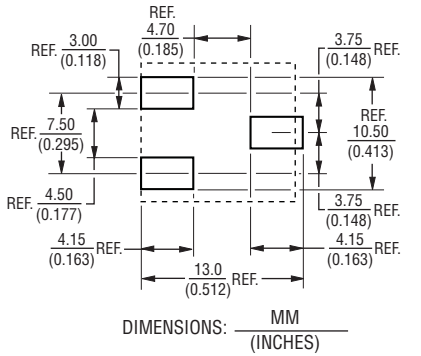

*RoHS Directive 2002/95/EC Jan 27, 2003 including Annex. Specifications are subject to change without notice. Customers should verify actual device performance in their specific applications.

SRP1205 Series - Shielded Power Inductors

BOURNS®

Soldering Profile

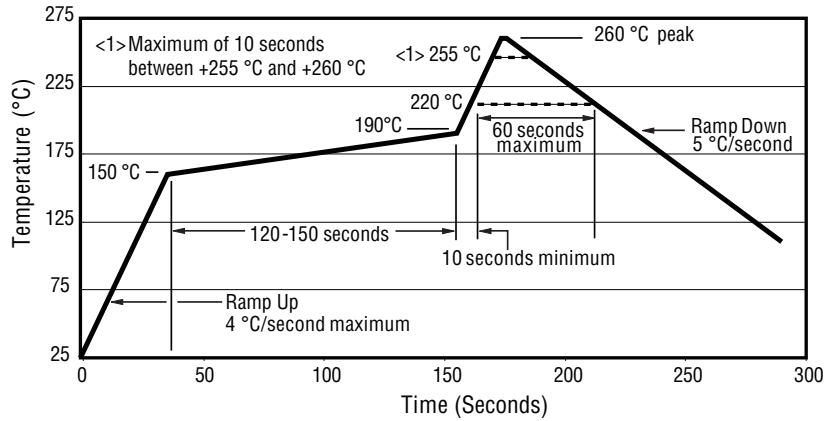

Packaging Specifications

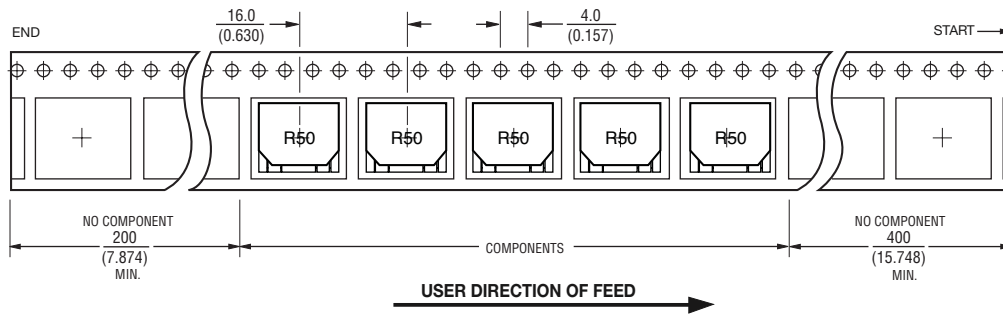
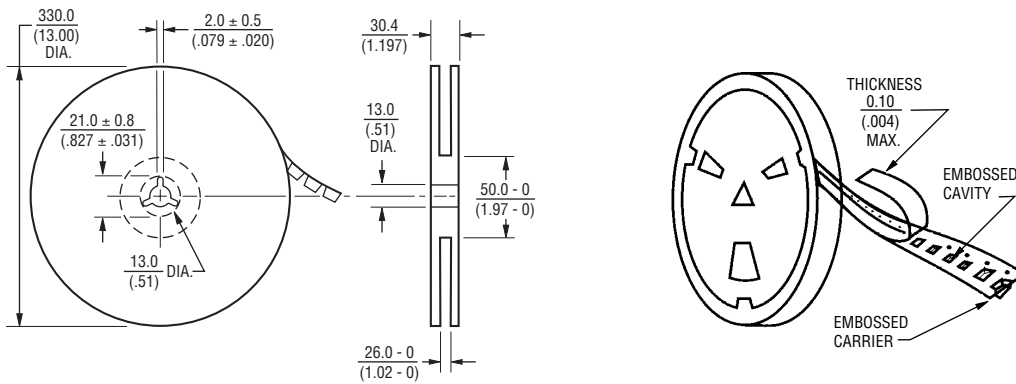

DIMENSIONS: $\frac{\text{MM}}{\text{(INCHES)}}$