

LC03-3.3 Series 3.3V 150A Diode Array

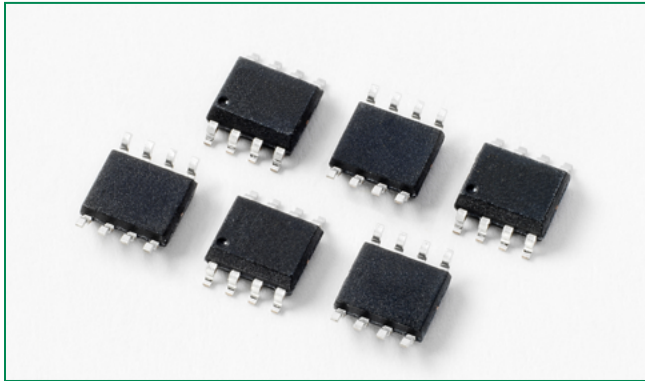

Pinout

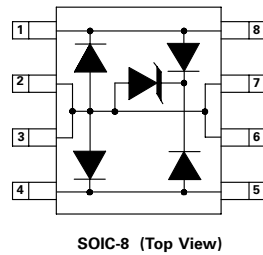

Functional Block Diagram

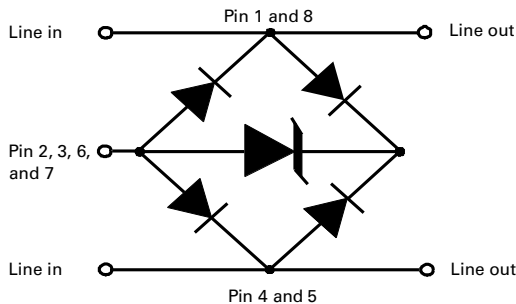

Additional Information



[Datashheet](#)



[Resources](#)



[Samples](#)

Life Support Note:

Not Intended for Use in Life Support or Life Saving Applications

The products shown herein are not designed for use in life sustaining or life saving applications unless otherwise expressly indicated.

Description

This LC03-3.3 series provides overvoltage protection for applications such as 10/100/1000 BaseT Ethernet, and T3/E3 interfaces. This new protector combines the TVS diode element with a diode rectifier bridge to provide both longitudinal and differential protection in one package. This design results in a capacitive loading characteristic that is log-linear with respect to the signal voltage across the device. This reduces intermodulation (IM) distortion caused by a typical solid-state protection solution. The application schematic provides the connection information and the LC03-3.3 is rated for GR-1089, intra-building transient immunity requirements for telecommunication installations.

Features

- Lightning Protection, IEC61000-4-5, 150A ($t_p=8/20\mu s$)
- EFT, IEC61000-4-4, 40A ($t_p=5/50ns$)
- Low insertion loss, log-linear capacitance
- Low clamping voltage
- SOIC-8 surface mount package (JEDEC MS-012)
- Combined longitudinal and metallic protection
- Clamping speed of nanoseconds
- UL 94V-0 epoxy molding
- RoHS compliant

Applications

- T1/E1 Line cards
- T3/E3 and DS3 Interfaces
- STS-1 Interfaces
- 10/100/1000 BaseT Ethernet

Application Example

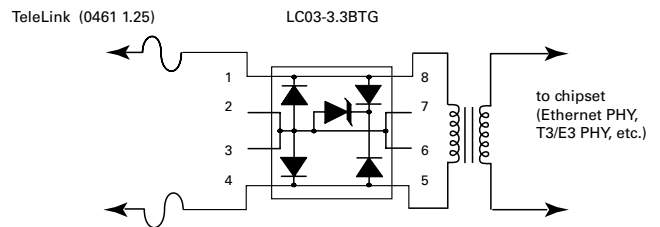

This schematic shows a high-speed data interface protection solution. The LC03-3.3BTG is compatible with the intra-building surge requirements of Telcordia's GR-1089-CORE, and the Basic Level Recommendations of ITU K.20 and K.21. The TeleLink fuse provides overcurrent protection for the long term 50/60 Hz power fault events.

Absolute Maximum Ratings

Parameter	Rating	Units
Peak Pulse Current (8/20μs)	150	A
Peak Pulse Power (8/20μs)	3300	W
IEC 61000-4-2, Direct Discharge, (Level 4)	30	kV
IEC 61000-4-2, Air Discharge, (Level 4)	30	kV
IEC 61000-4-5 (8/20μs)	150	A
Telcordia GR 1089 (Intra-Building) (2/10μs)	100	A
ITU K.20 (5/310μs)	40	A

CAUTION: Stresses above those listed in "Absolute Maximum Ratings" may cause permanent damage to the device. This is a stress only rating and operation of the device at these or any other conditions above those indicated in the operational sections of this specification is not implied.

Thermal Information

Parameter	Rating	Units
SOIC Package	170	°C/W
Operating Temperature Range	-40 to 125	°C
Storage Temperature Range	-55 to 150	°C
Maximum Junction Temperature	150	°C
Maximum Lead Temperature (Soldering 20-40s) (SOIC - Lead Tips Only)	260	°C

Electrical Characteristics (T_{OP} = 25°C)

Parameter	Symbol	Test Conditions	Min	Typ	Max	Units
Reverse Stand-Off Voltage	V _{RWM}	I _T ≤ 1μA	-	-	3.3	V
Reverse Breakdown Voltage	V _{BR}	I _T = 2μA	3.3	-	-	V
Snap Back Voltage	V _{SB}	I _T = 50mA	3.3	-	-	V
Reverse Leakage Current	I _R	V _{RWM} = 3.3V, T = 25°C	-	-	1	μA
Clamping Voltage, Line-Ground	V _C	I _{PP} = 50A, t _p = 8/20 μs	-	-	13	V
Clamping Voltage, Line-Ground	V _C	I _{PP} = 100A, t _p = 8/20 μs	-	-	17	V
Dynamic Resistance, Line-Ground	R _{DYN}	(V _{C2} - V _{C1}) / (I _{PP2} - I _{PP1})	-	0.15	-	Ω
Clamping Voltage, Line-Line	V _C	I _{PP} = 50A, t _p = 8/20 μs	-	-	15	V
Clamping Voltage, Line-Line	V _C	I _{PP} = 100A, t _p = 8/20 μs	-	-	20	V
Dynamic Resistance, Line-Line	R _{DYN}	(V _{C2} - V _{C1}) / (I _{PP2} - I _{PP1})	-	0.25	-	Ω
Junction Capacitance	C _J	Between I/O Pins and Ground V _R = 0V, f = 1MHz	-	9	12	pF
		Between I/O Pins V _R = 0V, f = 1MHz	-	4.5	6	pF

Figure 1: Non-repetitive Peak Pulse Current vs. Pulse Time

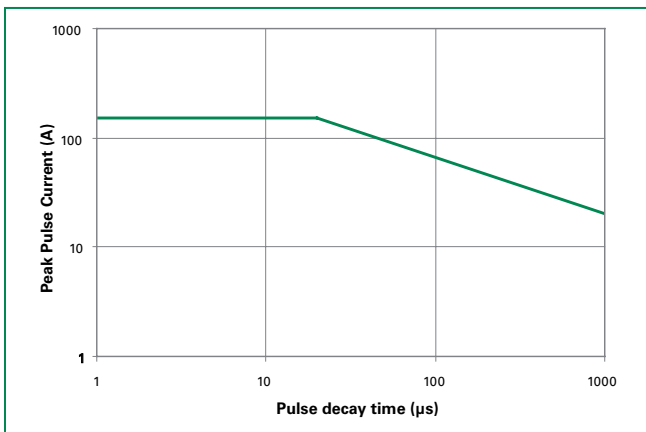

Figure 2: Current Derating Curve

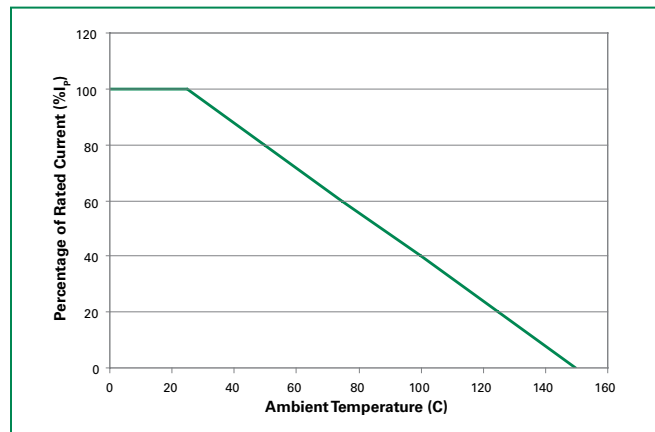

Figure 3: Pulse Waveform

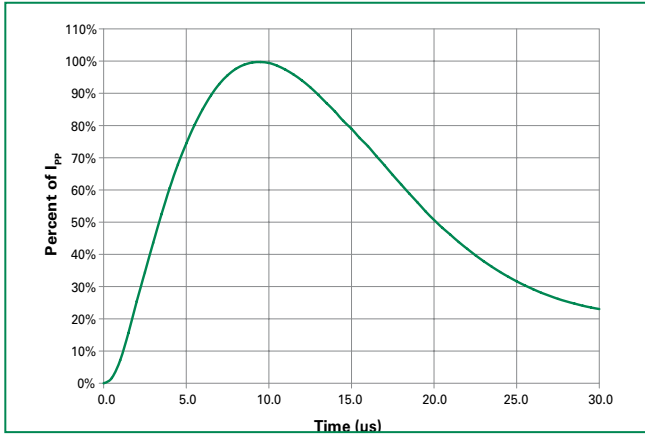

Figure 4: Clamp Voltage vs. Peak Pulse Current

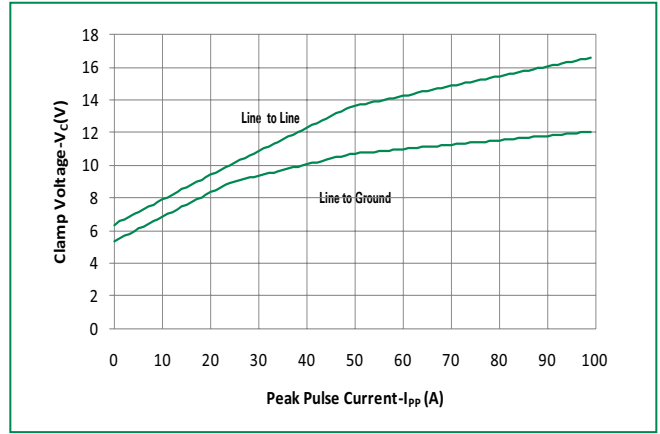

Figure 5: Capacitance vs. Reverse Voltage

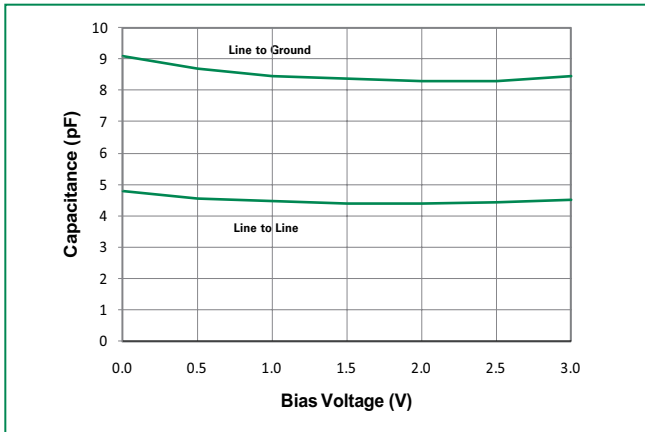
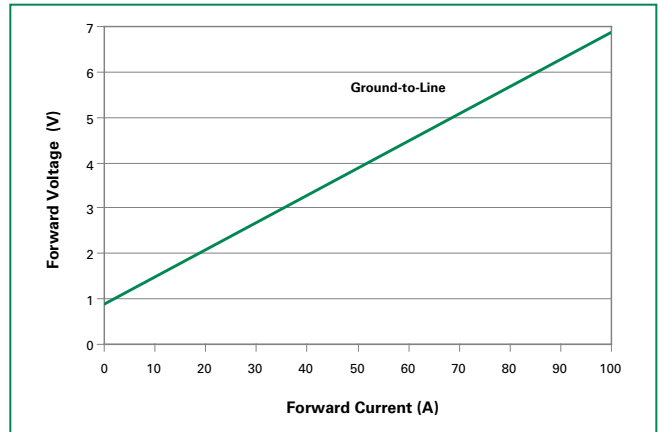
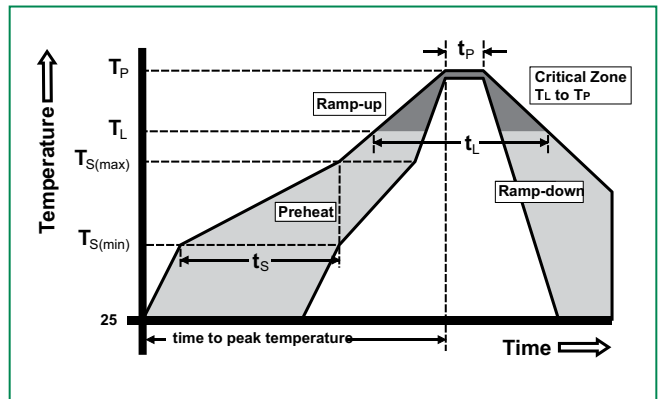

Figure 6: Forward Voltage vs. Forward Current



Soldering Parameters

Reflow Condition		Pb – Free assembly
Pre Heat	- Temperature Min ($T_{s(min)}$)	150°C
	- Temperature Max ($T_{s(max)}$)	200°C
	- Time (min to max) (t_s)	60 – 180 secs
Average ramp up rate (Liquidus) Temp (T_L) to peak		3°C/second max
$T_{s(max)}$ to T_L - Ramp-up Rate		3°C/second max
Reflow	- Temperature (T_L) (Liquidus)	217°C
	- Temperature (t_L)	60 – 150 seconds
Peak Temperature (T_p)		260 ^{+0/-5} °C
Time within 5°C of actual peak Temperature (t_p)		20 – 40 seconds
Ramp-down Rate		6°C/second max
Time 25°C to peak Temperature (T_p)		8 minutes Max.
Do not exceed		260°C



Package Dimensions – Mechanical Drawings and Recommended Solder Pad Outline

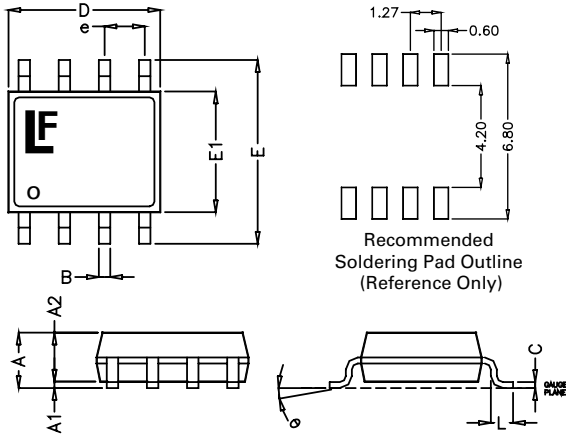

Package	SOIC-8			
Pins	8			
JEDEC	MS-012			
	Millimetres		Inches	
	Min	Max	Min	Max
A	1.35	1.75	0.053	0.069
A1	0.10	0.25	0.004	0.010
A2	1.25	1.65	0.050	0.065
B	0.31	0.51	0.012	0.020
c	0.17	0.25	0.007	0.010
D	4.80	5.00	0.189	0.197
E	5.80	6.20	0.228	0.244
E1	3.80	4.00	0.150	0.157
e	1.27 BSC		0.050 BSC	
L	0.40	1.27	0.016	0.050

Embossed Carrier Tape & Reel Specification – SOIC Package

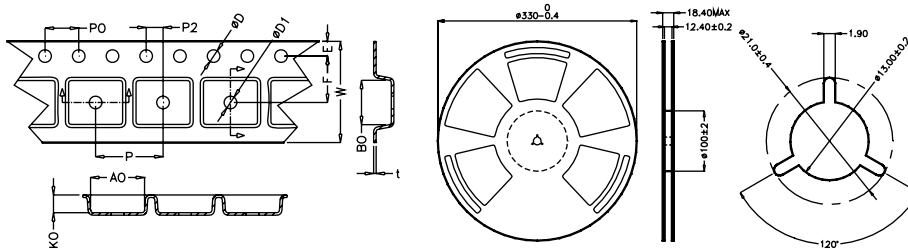

	Millimetres		Inches	
	Min	Max	Min	Max
E	1.65	1.85	0.065	0.073
F	5.4	5.6	0.213	0.22
P2	1.95	2.05	0.077	0.081
D	1.5	1.6	0.059	0.063
D1	1.50 Min		0.059 Min	
P0	3.9	4.1	0.154	0.161
10P0	40.0 ± 0.20		1.574 ± 0.008	
W	11.9	12.1	0.468	0.476
P	7.9	8.1	0.311	0.319
A0	6.3	6.5	0.248	0.256
B0	5.1	5.3	0.2	0.209
K0	2	2.2	0.079	0.087
t	0.30 ± 0.05		0.012 ± 0.002	

Part Numbering System

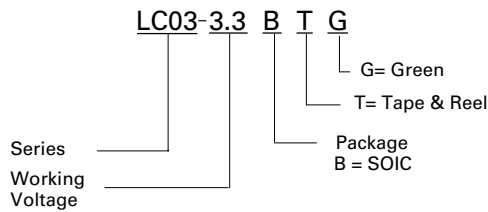

Part Marking System

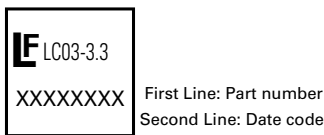

Ordering Information

Part Number	Package	Marking	Min. Order Qty.
LC03-3.3BTG	SOIC-8	LC03-3.3	2500

Product Characteristics

Lead Plating	Matte Tin
Lead Material	Copper Alloy
Lead Coplanarity	0.004 inches (0.102mm)
Substitute Material	Silicon
Body Material	Molded Epoxy
Flammability	UL 94 V-0

- Notes :
- All dimensions are in millimeters
 - Dimensions include solder plating.
 - Dimensions are exclusive of mold flash & metal burr.
 - Blo is facing up for mold and facing down for trim/form, i.e. reverse trim/form.
 - Package surface matte finish VDI 11-13.