

Passive components Sales Office

• Head Office

206, Cheomdansaneop Road,
Youngtong-gu,
Suwon, Kyonggi Province 443-743,
Korea

Europe

Tel: +82-31-210-6328
E-mail: james.pyun@samsung.com

America

Tel: +82-31-210-6794
E-mail: randy.kim@samsung.com

Asia

Tel: +82-31-210-5348
E-mail: koogi@samsung.com

Domestic

Tel: +82-31-210-3757
E-mail: southjoy@samsung.com

• Manufacturing Site

Suwon Plant

206 Cheomdansaneop Road,
Youngtong-gu,
Suwon, Kyonggi Province 443-743,
Korea
Tel: +82-31-210-6794
E-mail: randy.kim@samsung.com

Busan Plant

1623-2, Songjeong-dong,
Kangseo-gu, Busan 618-270, Korea
Tel: +82-51-970-7671
E-mail: kyc.kweon@samsung.com

Tianjin Plant

27, Heiniucheng-Road, Hexi District,
Tianjin, China 300210
Tel: +86-22-2830-3333(3450)
E-mail: gk.ryu@samsung.com

Philippines Plant

Calamba Premiere International Park,
Batino, Calamba, Laguna, Manila
Tel: +63-2-809-2873
E-mail: ks1445@samsung.com

• Asia sales office

Shanghai Office

Rm 1408 Shanghai international
trade center No 2200 Yan an(W) RD
Shanghai China 200335
Tel: 86-21-6270-4168(274)
E-mail: dennis.cha@samsung.com

Shenzhen Office

Rm 4501, 45/F, New World Center,
Yitian Road, Futian District,
Shenzhen, China 518026
Tel: 86-755-8608-5581
E-mail: jackson.xian@samsung.com

Qingdao Office

Rm 1201, Growne Plaza Qingdao;
76XiangGangZhong Rd, Qingdao;266071
P.R. China
Tel: 86-532-5779102
E-mail: zhengguo.cui@samsung.com

HongKong Office

Suite 4511, Two int'l Finance Centre,
8 Finance Street, Central, Hongkong
Tel: 852-2862-6350
E-mail: vinsent.chou@samsung.com

Singapore Office

3 Church Street Samsung Hub
#23-02 Singapore 049483
Tel: (65)6833-3228
E-mail: winson.yeong@samsung.com

Thai Office

Wellgrow Industrial Estate,
93 Moo 5 T. Bangsamak, A.Bangpakong
Chachoengsao 24180 Thailand
Tel: 66-38-562-026
E-mail: sbimm@samsung.com

Taiwan Office

399 9F-1, Ruey Kuang Rd., Neihu,
Taipei, Taiwan
Tel: 886-2-2656-8356
E-mail: kevin0130.wang@samsung.com

• America sales office

Irvine Office

92612 3345 Michelson Drive,
Suite 350, Irvine, CA
Tel: 1-949-797-8047
E-mail: sh386.kim@samsung.com

• Europe sales office

Frankfurt Office

Samsung haus
Am Kronberger Hang 6
D-65824 Schwalbach/Ts.
Tel: 49-6196-66-7255
FAX: 49-(0)6196-66-7755
E-mail: frank.goebel@samsung.com

Hungary Office

H2310, Szigetszentmiklos, Leshegy u.
2-4, Hungary
Tel: 36-24-551-148
E-mail: jun21c.lee@samsung.com

• Domestic Distributors

KORCHIP INC

#219-8 Gasan-dong, Gumchun-gu,
Seoul, Korea
Tel: +82-2-838-5588
E-mail: hjh0064@korchip.com

CHUNG HAN

#16-96 Hangang-lo 3, Youngsan-Gu,
Seoul, Korea
Tel: +82-2-718-3322
E-mail: bu1230choi@hanmail.net

SAMT

Daekyung Bldg., Daechi-Dong,
Gangnam-Gu, Seoul, Korea
Tel: +82-2-3458-9000
E-mail: info@isamt.com

CHUNGMAC

#53-5 Wonhyol3 Youngsan-gu,
Seoul, Korea
Tel: +82-2-716-6428~9
E-mail: webmaster@anycam.co.kr

APEXINT

Room #905, C-dong Woorimlion's,
Valley 371-28, Gasan-dong,
Guemcheon-Gu, Seoul, Korea
Tel: +82-2-2026-2610(2)
E-mail: info@apexint.co.kr

MULTILAYER CHIP COMPONENTS

CHIP INDUCTOR / BEADS
EMI / ESD PRODUCTS
PRODUCTS for
COMMUNICATION EQUIPMENT

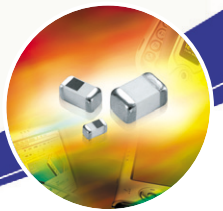
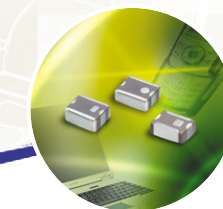



We, Samsung, declare that our component Chip Bead / Inductor is produced in accordance with EU RoHS directive.

1. RoHS Compliance and restriction of Br

The following restricted materials are not used in packaging materials as well as products in compliance with the law and restriction.

- Cd, Pb, Hg, Cr+6, As, Br and the compounds, PCB, asbestos
- Bromic materials : PBBs, PBBOs, PBDO, PBDE, PBB

2. No use of materials breaking Ozone layer

The following ODS materials are not used in our fabrication process.

- ODS material : Freon, Haron, 1-1-1 TCE, CCl4, HCFC

If you want more detailed Information, Please Visit Samsung Electro-mechanics Website [<http://www.sem.samsung.com>]

Certification list of Samsung Factory

Certification	TL 9000 (Product)	ISO 14001 (Factory)	ISO / TS16949:2002 (Product)	OSHAS 18001
BUSAN	BSI FM90588	BSI EMS66454	BSI FMS91430-001	BSI OHS54743

CONTENTS



Chip Beads

CIB/CIM Series 4

CIA Series 16

CIC/CIS Series 20



Chip Inductors

CIL Series 29

CIH Series 35

Power Inductor 39



EMI/ESD Products

EMI/ESD Filter 42

3-Terminal Capacitor 45



Products For Communication Equipment

Diplexer 47

Band Pass/Low Pass Filter 53

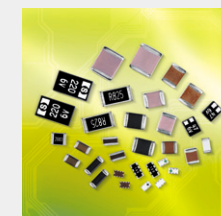

Appendix

Soldering Condition 59

Packaging 60

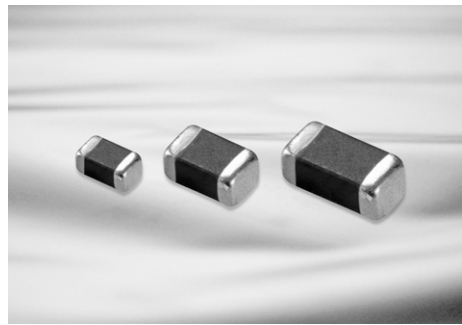

Feature

- Smallest beads suitable for surface mounting
- Perfect shape for automatic mounting, with no directionality.
- Excellent solderability and high heat resistance for either flow or reflow soldering.
- Monolithic inorganic material construction for high reliability.
- Closed magnetic circuit configuration avoids crosstalk and is suitable for high density PCBs.

Application

- High frequency EMI prevention application to computers, printers, VCRs, TVs and portable telephones.

The CIB/CIM Series are used for EMI suppression filter. These beads suppress electro-magnetic wave noise by increased impedance, especially by increased resistance at noise frequency.

CIB Series

The CIB Series is composed of mono-layer internal conductor that allows low impedance and low DC resistance.

CIM Series

The CIM Series display high impedance because it is composed of a multilayered internal conductor and has excellent attenuation characteristics for wide band frequencies.

Dimensions

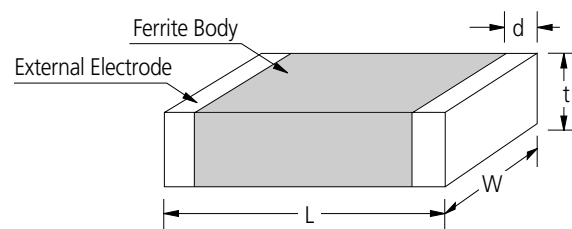

Unit: mm

SIZE CODE	L	W	t	d
03	0.6±0.03	0.3±0.03	0.3±0.03	0.15±0.05
05	1.0±0.05	0.5±0.05	0.5±0.05	0.25±0.1
10	1.6±0.15	0.8±0.15	0.8±0.15	0.3±0.2
21	2.0±0.2	1.25±0.2	0.9±0.2	0.5+0.2,-0.3
31	3.2±0.2	1.6±0.2	1.1±0.2	0.5+0.2,-0.3
32	3.2±0.2	2.5±0.2	1.3±0.2	0.5±0.3
41	4.5±0.2	1.6±0.2	1.6±0.2/1.2±0.2	0.5±0.3
43	4.5±0.2	3.2±0.2	1.5±0.2	0.5±0.3

Part Numbering

CI **M** **03** **J** **121** **N** **E**
(1) (2) (3) (4) (5) (6) (7)

(1) Chip Beads

(2) B: Mono-layer type, M: Multi-layer type

(3) Dimension

(4) Material Code

P,U: Broad impedance, especially suppresses noise in the 10~200MHz range

J : Suppresses noise in the 100~300MHz range

K : Suppresses noise in the 200MHz above

N : Suppresses noise in the 200~500MHz range

(5) Nominal impedance (110: 11Ω ; 121: 120Ω)

(6) Thickness option (N: Standard, A: Thinner than standard, B: Thicker than standard)

(7) Packaging (C: paper tape, E: embossed tape)

CIM 0603(0201) Type

Part No.	Thickness (mm)	Impedance (Ω)±25% @ 100 MHz	DC Resistance (Ω) Max.	Rated Current (mA) Max.
CIM 03N 300	0.3±0.03	30	0.8	150
CIM 03N 800	0.3±0.03	80	1.2	100
CIM 03U 800	0.3±0.03	80	0.5	200
CIM 03U 121	0.3±0.03	120	0.8	200
CIM 03U 241	0.3±0.03	240	1.0	100
CIM 03U 471	0.3±0.03	470	1.8	100
CIM 03U 601	0.3±0.03	600	2.0	100
CIM 03J 121	0.3±0.03	120	0.8	200
CIM 03J 241	0.3±0.03	240	1.0	100
CIM 03J 471	0.3±0.03	470	1.8	50
CIM 03J 601	0.3±0.03	600	2.0	50

CIM 1005(0402) Type

Part No.	Thickness (mm)	Impedance (Ω)±25% @ 100 MHz	DC Resistance (Ω) Max.	Rated Current (mA) Max.
CIM 05U 100	0.5±0.05	10	0.05	1200
CIM 05U 300	0.5±0.05	30	0.10	700
CIM 05U 600	0.5±0.05	60	0.15	600
CIM 05U 800	0.5±0.05	80	0.20	600
CIM 05U 121	0.5±0.05	120	0.25	500
CIM 05U 241	0.5±0.05	240	0.35	400
CIM 05U 301	0.5±0.05	300	0.45	400
CIM 05U 471	0.5±0.05	470	0.55	300
CIM 05U 601	0.5±0.05	600	0.60	250
CIM 05U 102	0.5±0.05	1000	1.00	200
CIM 05J 300	0.5±0.05	30	0.20	700
CIM 05J 600	0.5±0.05	60	0.20	600
CIM 05J 800	0.5±0.05	80	0.25	600
CIM 05J 121	0.5±0.05	120	0.30	500
CIM 05J 241	0.5±0.05	240	0.35	400
CIM 05J 301	0.5±0.05	300	0.45	400
CIM 05J 471	0.5±0.05	470	0.55	300
CIM 05J 601	0.5±0.05	600	0.60	300
CIM 05J 102	0.5±0.05	1000	0.80	250
CIM 05J 152	0.5±0.05	1500	1.00	250
CIM 05J 182	0.5±0.05	1800	1.40	100

CIB/CIM 1608(0603) Type

Part No.	Thickness (mm)	Impedance (Ω) \pm 25% @ 100 MHz	DC Resistance (Ω) Max.	Rated Current (mA) Max.
CIB 10P 260	0.8 \pm 0.15	26	0.08	1000
CIB 10P 330	0.8 \pm 0.15	33	0.08	1000
CIM 10U 121	0.8 \pm 0.15	120	0.15	500
CIM 10U 241	0.8 \pm 0.15	240	0.30	400
CIM 10U 471	0.8 \pm 0.15	470	0.35	300
CIM 10U 601	0.8 \pm 0.15	600	0.45	300
CIM 10U 102	0.8 \pm 0.15	1000	0.60	250
CIM 10U 202	0.8 \pm 0.15	2000(at 70MHz)	1.20	200
CIM 10J 400	0.8 \pm 0.15	40	0.12	600
CIM 10J 600	0.8 \pm 0.15	60	0.12	600
CIM 10J 800	0.8 \pm 0.15	80	0.20	550
CIM 10J 121	0.8 \pm 0.15	120	0.20	500
CIM 10J 151	0.8 \pm 0.15	150	0.20	400
CIM 10J 241	0.8 \pm 0.15	240	0.30	400
CIM 10J 471	0.8 \pm 0.15	470	0.35	300
CIM 10J 601	0.8 \pm 0.15	600	0.45	300
CIM 10J 751	0.8 \pm 0.15	750	0.55	300
CIM 10J 102	0.8 \pm 0.15	1000	0.70	250
CIM 10J 152	0.8 \pm 0.15	1500	1.00	250
CIM 10K 152	0.8 \pm 0.15	1500	0.80	250
CIM 10K 202	0.8 \pm 0.15	2000	1.00	200
CIM 10K 252	0.8 \pm 0.15	2500	1.20	200
CIM 10N 700	0.8 \pm 0.15	70	0.30	500
CIM 10N 121	0.8 \pm 0.15	120	0.45	400
CIM 10N 241	0.8 \pm 0.15	240	0.60	300
CIM 10 F 600	0.8 \pm 0.15	60	0.70	200

CIB/CIM 2012(0805) Type

Part No.	Thickness (mm)	Impedance (Ω) \pm 25% @ 100 MHz	DC Resistance (Ω) Max.	Rated Current (mA) Max.
CIB 21P 110	0.9 \pm 0.2	11	0.05	2000
CIB 21P 150	0.9 \pm 0.2	15	0.05	2000
CIB 21P 260	0.9 \pm 0.2	26	0.05	2000
CIB 21P 330	0.9 \pm 0.2	33	0.05	1500
CIB 21P 470	0.9 \pm 0.2	47	0.05	1500
CIM 21U 800	0.9 \pm 0.2	80	0.10	900
CIM 21U 101	0.9 \pm 0.2	100	0.10	500
CIM 21U 121	0.9 \pm 0.2	120	0.10	500
CIM 21U 151	0.9 \pm 0.2	150	0.15	400
CIM 21U 241	0.9 \pm 0.2	240	0.15	400
CIM 21U 301	0.9 \pm 0.2	300	0.15	400
CIM 21U 471	0.9 \pm 0.2	470	0.25	400
CIM 21U 601	0.9 \pm 0.2	600	0.30	400
CIM 21U 102	0.9 \pm 0.2	1000(at 70MHz)	0.45	400
CIM 21U 202	0.9 \pm 0.2	2000(at 70MHz)	0.70	300
CIB 21J 260	0.9 \pm 0.2	26	0.05	2000
CIB 21J 400	0.9 \pm 0.2	40	0.05	2000
CIM 21J 600	0.9 \pm 0.2	60	0.08	900
CIM 21J 800	0.9 \pm 0.2	80	0.08	900
CIM 21J 121	0.9 \pm 0.2	120	0.15	600
CIM 21J 151	0.9 \pm 0.2	150	0.15	500
CIM 21J 241	0.9 \pm 0.2	240	0.20	400
CIM 21J 301	0.9 \pm 0.2	300	0.25	400
CIM 21J 471	0.9 \pm 0.2	470	0.25	400
CIM 21J 601	0.9 \pm 0.2	600	0.25	400
CIM 21J 102	0.9 \pm 0.2	1000	0.40	400
CIM 21J 152	0.9 \pm 0.2	1500(at 70MHz)	0.55	300
CIM 21J 182	0.9 \pm 0.2	1800(at 70MHz)	0.45	300
CIM 21J 202	0.9 \pm 0.2	2000(at 70MHz)	0.50	300
CIM 21K 152	0.9 \pm 0.2	1500	0.45	300
CIM 21K 252	0.9 \pm 0.2	2500	0.80	250
CIM 21N 700	0.9 \pm 0.2	70	0.20	600
CIM 21N 121	0.9 \pm 0.2	120	0.25	500
CIM 21N 241	0.9 \pm 0.2	240	0.3	400

CIB/CIM 3216(1206) Type

Part No.	Thickness (mm)	Impedance (Ω) \pm 25% @ 100 MHz	DC Resistance (Ω) Max.	Rated Current (mA) Max.
CIB 31P 260	1.1 \pm 0.2	26	0.05	2000
CIB 31P 310	1.1 \pm 0.2	31	0.05	2000
CIB 31P 500	1.1 \pm 0.2	50	0.05	2000
CIB 31P 700	1.1 \pm 0.2	70	0.1	1500
CIM 31U 101	1.1 \pm 0.2	10	0.15	500
CIM 31U 601	1.1 \pm 0.2	600	0.3	400
CIM 31J 151	1.1 \pm 0.2	150	0.2	500
CIM 31J 221	1.1 \pm 0.2	220	0.2	400
CIM 31J 301	1.1 \pm 0.2	300	0.25	400
CIM 31J 601	1.1 \pm 0.2	600	0.3	400
CIM 31J 801	1.1 \pm 0.2	800	0.4	400
CIM 31J 102	1.1 \pm 0.2	1000	0.45	400
CIM 31J 152	1.1 \pm 0.2	1500(at 70MHz)	0.55	300

Other Types

Part No.	Thickness (mm)	Impedance (Ω) $\pm 25\%$ @ 100 MHz	DC Resistance (Ω) Max.	Rated Current (mA) Max.
CIB 32P 310	1.3 \pm 0.2	31	0.02	3000
CIB 32P 600	1.3 \pm 0.2	60	0.02	1500
CIB 41P 800	1.6 \pm 0.2	80	0.03	1000
CIB 41P 151	1.6 \pm 0.2	150	0.05	1000
CIB 43P 131	1.5 \pm 0.2	130	0.04	600
CIB 43P 151	1.5 \pm 0.2	150	0.04	600

Customized products are available.
 Test equipment : Agilent E4991A+16197A (0603)
 Agilent 4291B+16192A (1005)
 Agilent 4291B+16193A (1608 and others)

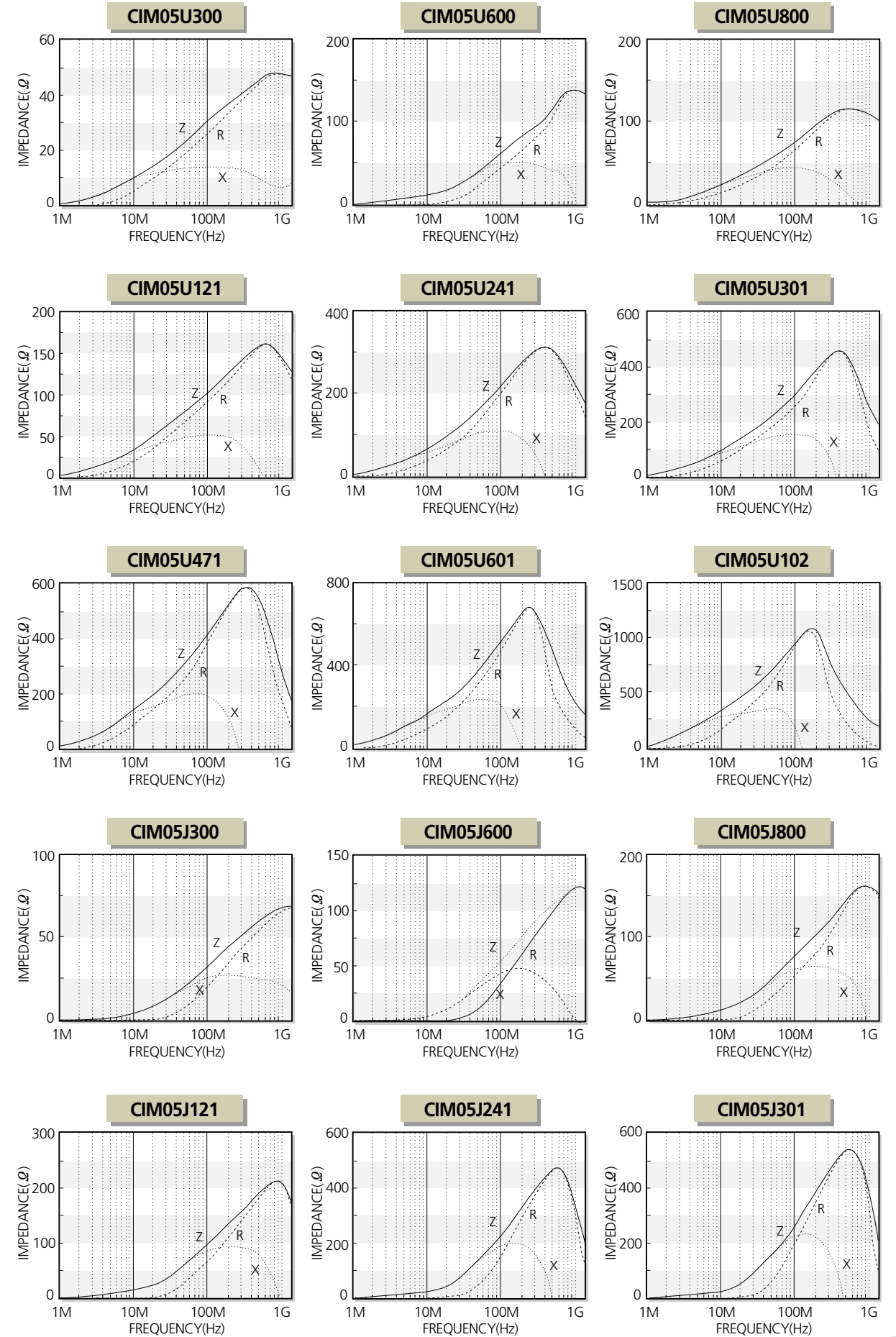
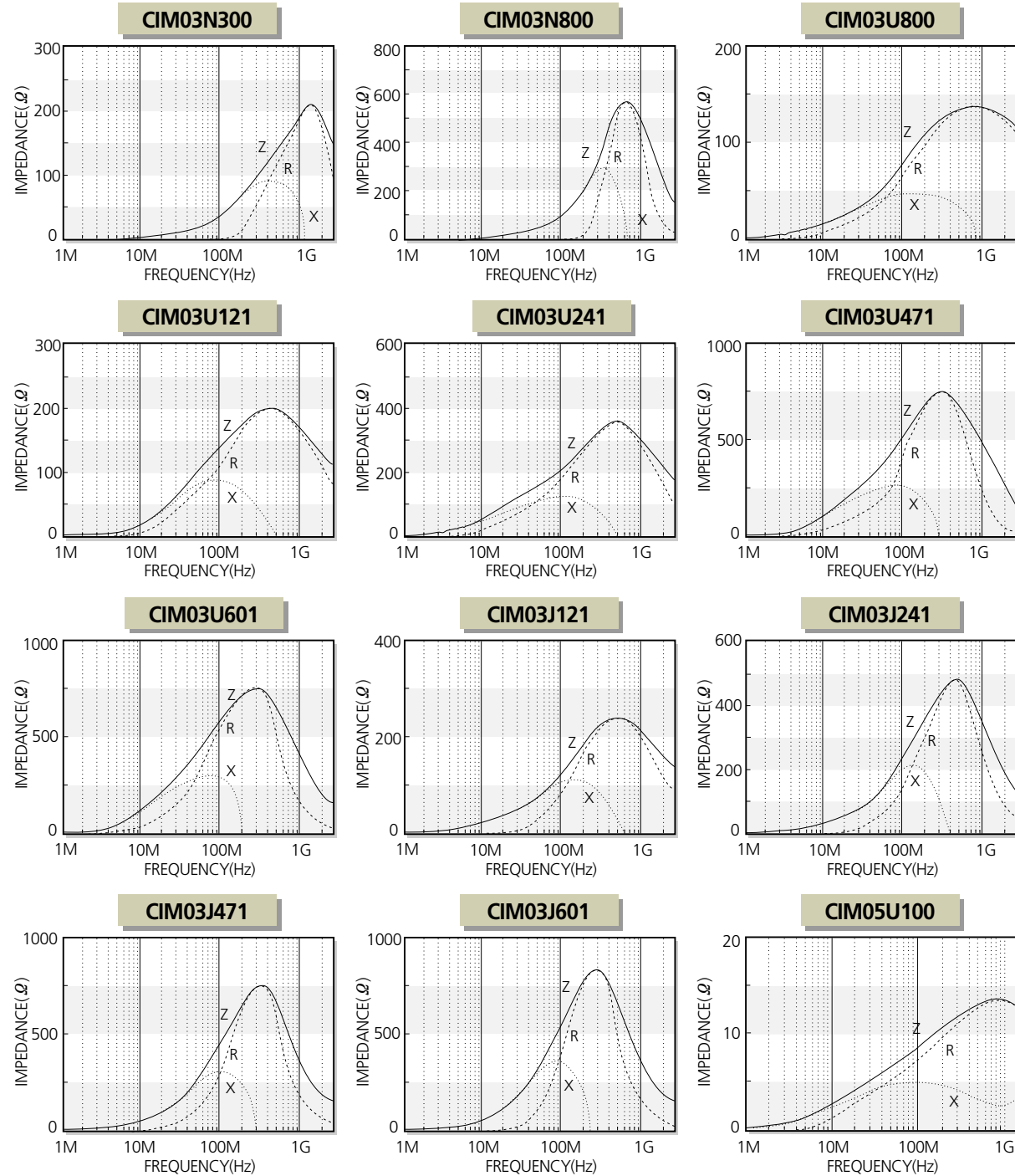

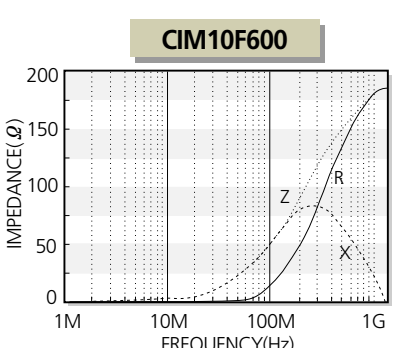
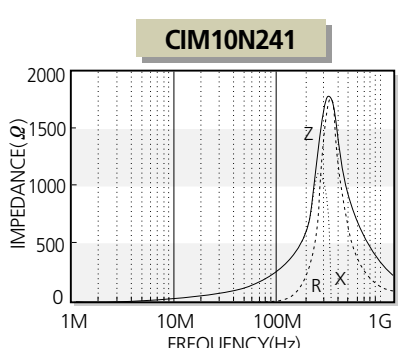
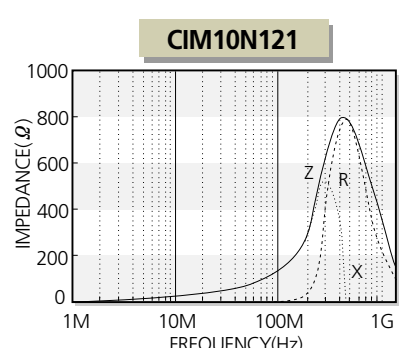
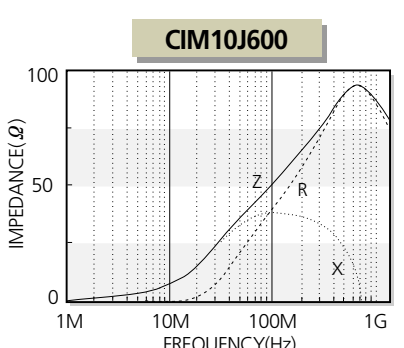
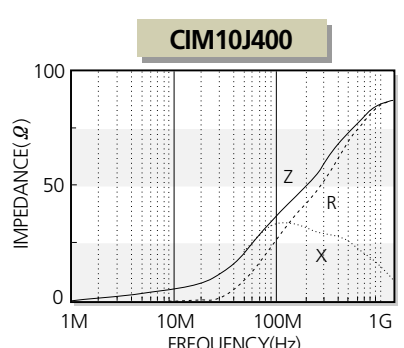
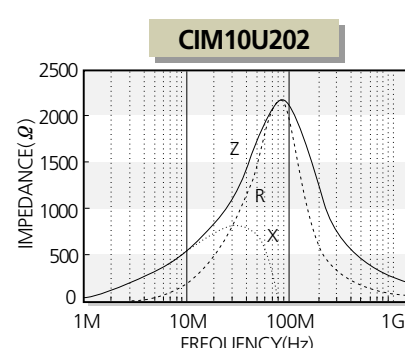
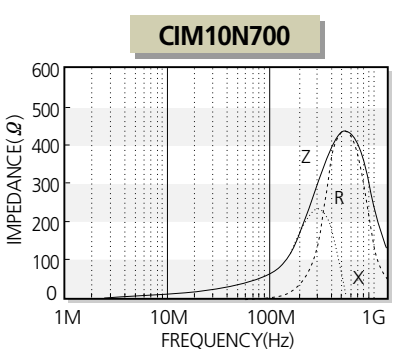
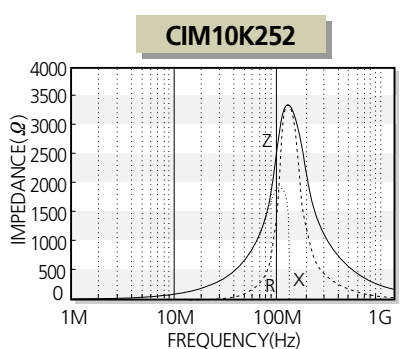
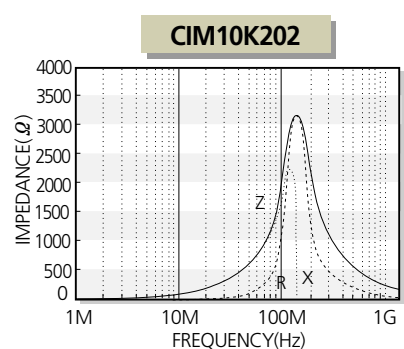
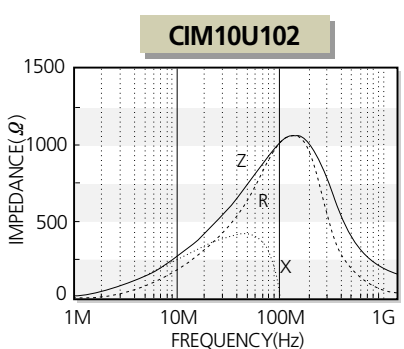
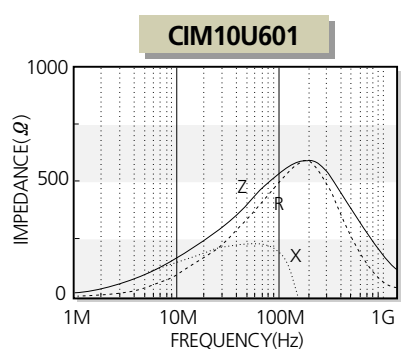
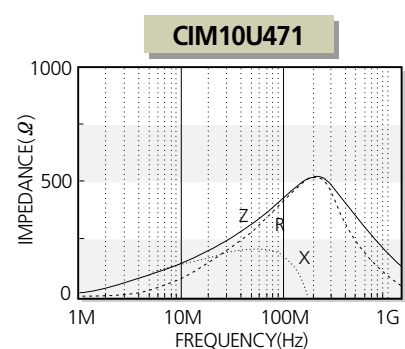
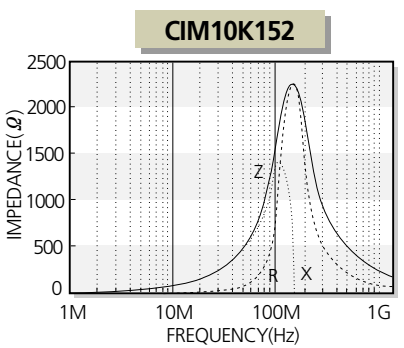
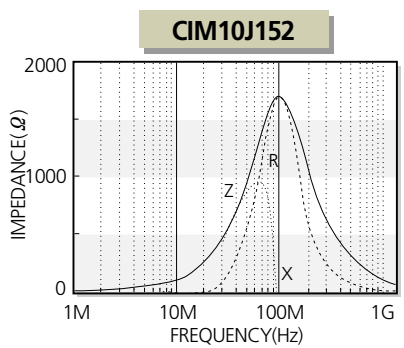
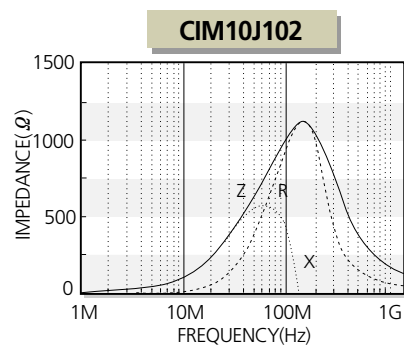
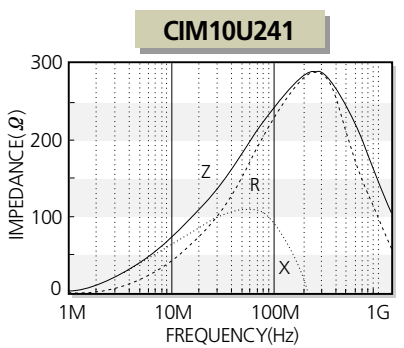
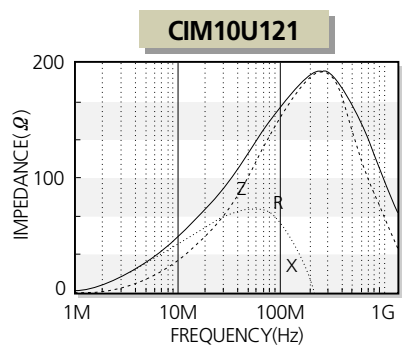
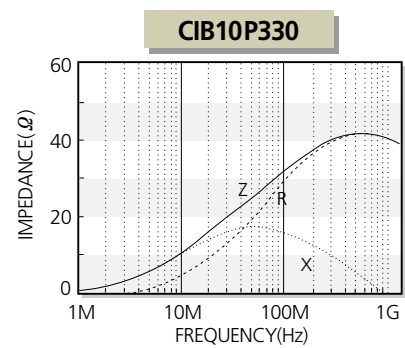
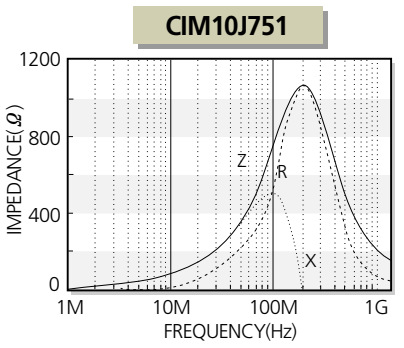
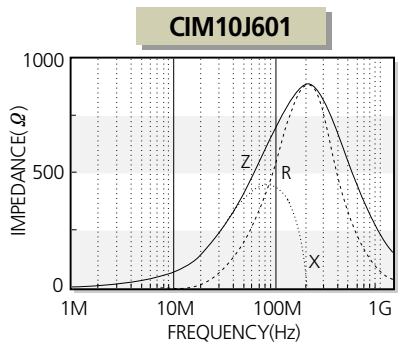
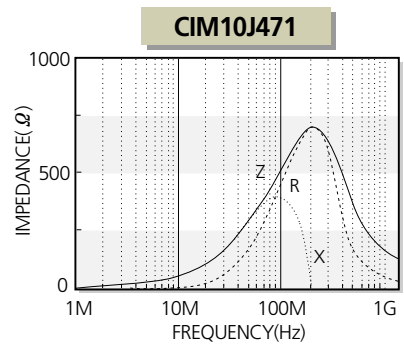
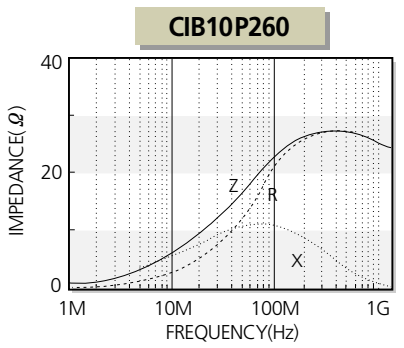
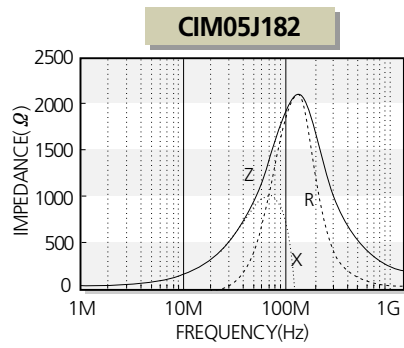
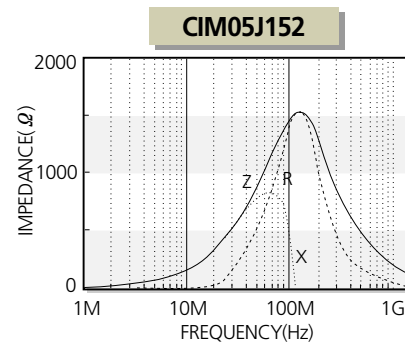
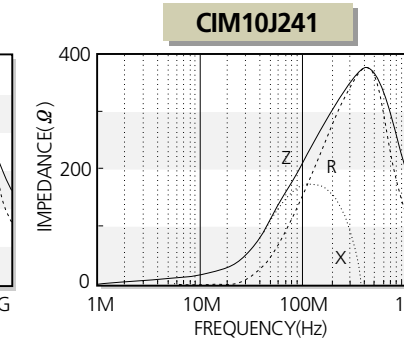
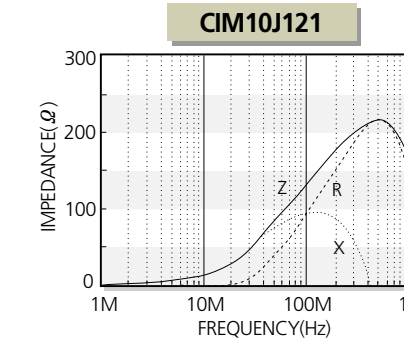
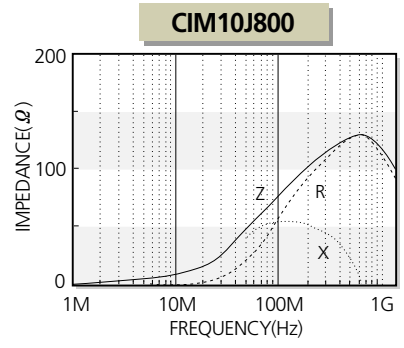
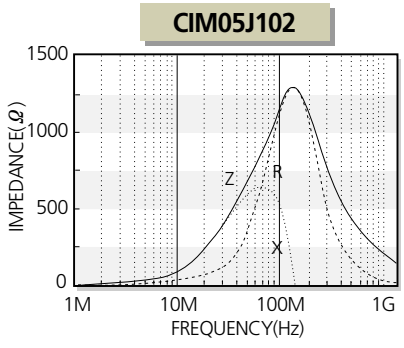
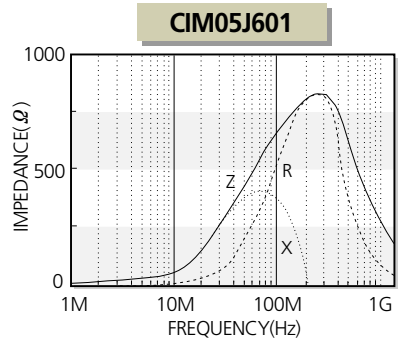
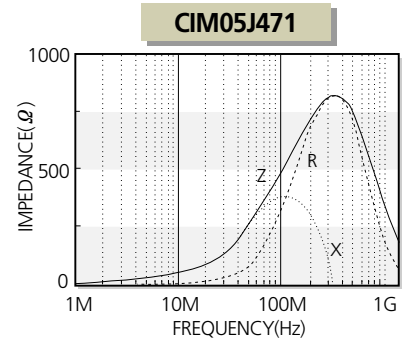

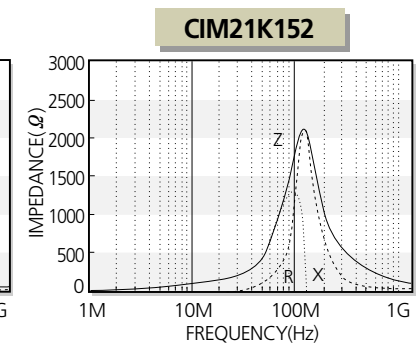
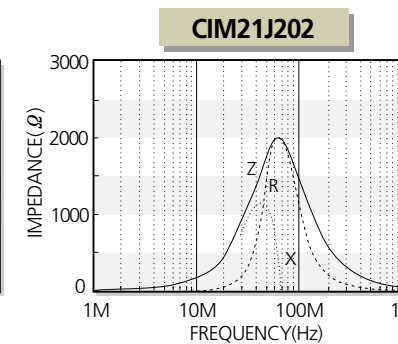
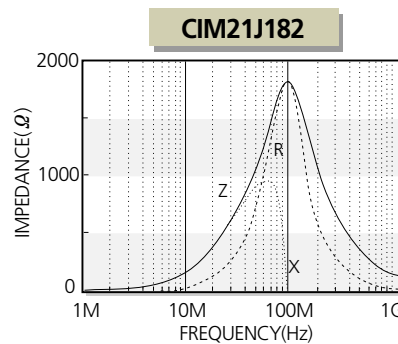
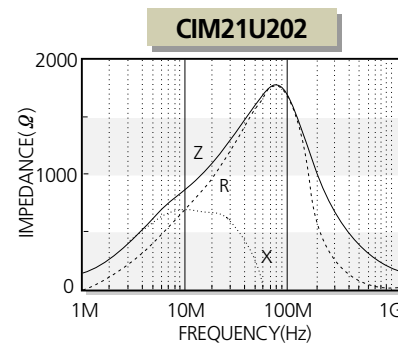
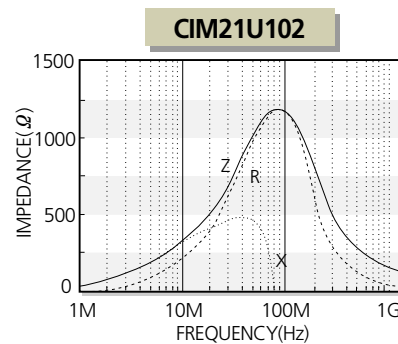
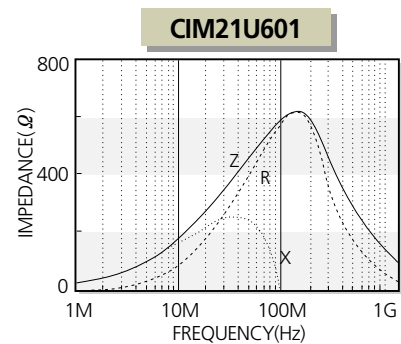
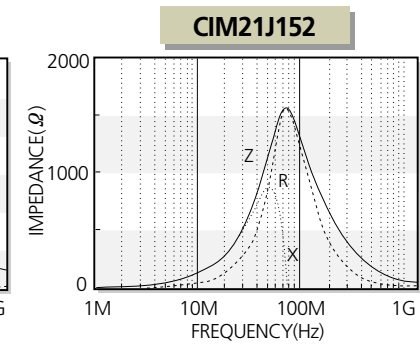
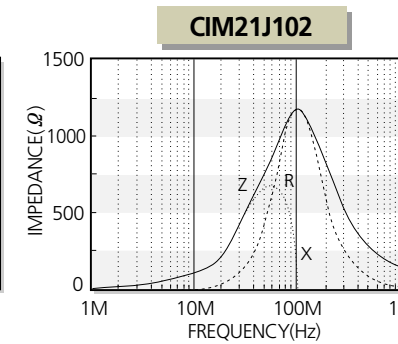
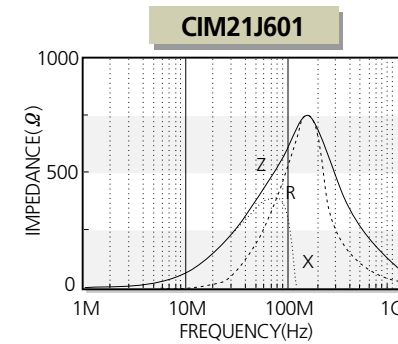
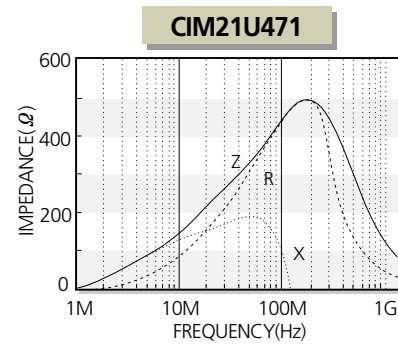
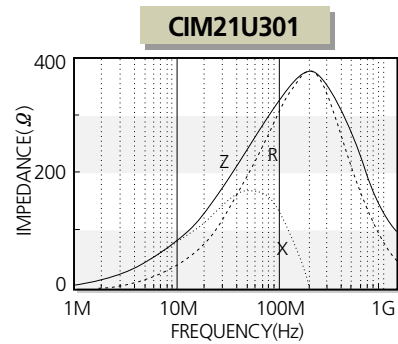
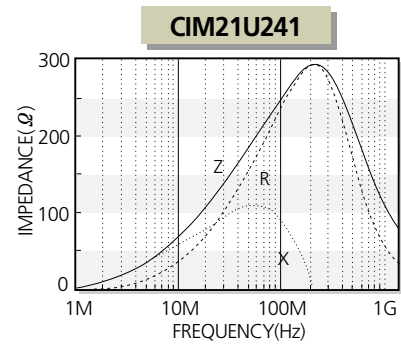
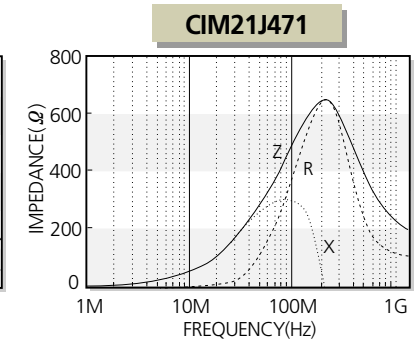
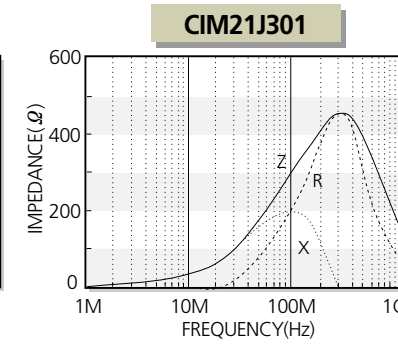
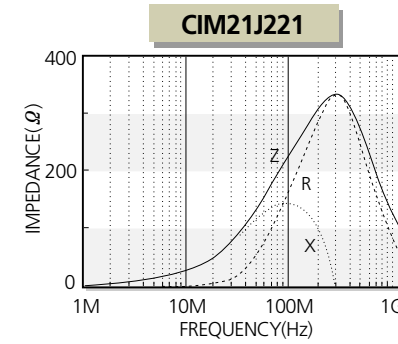
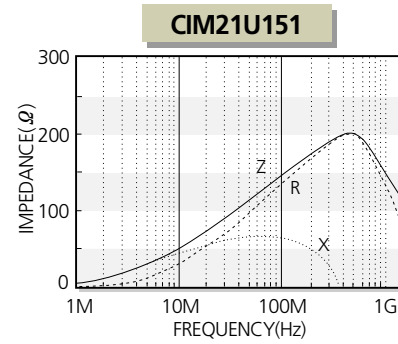
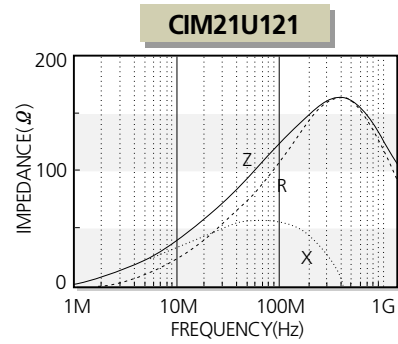
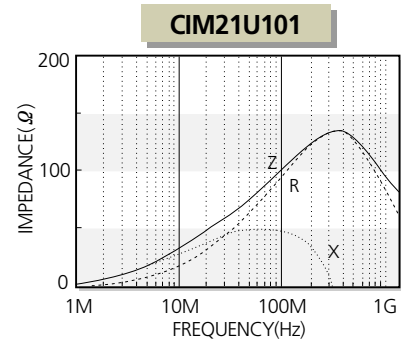
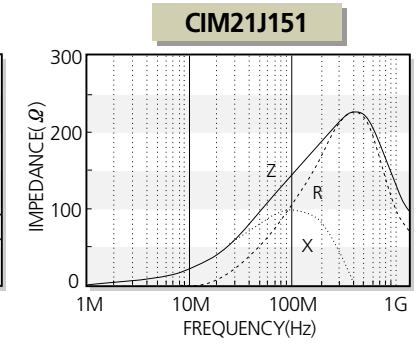
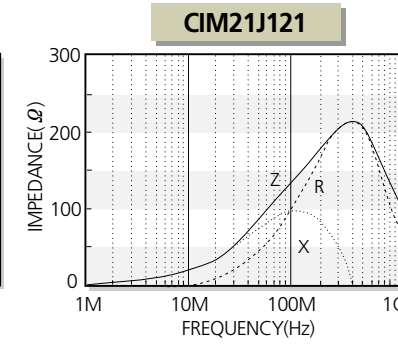
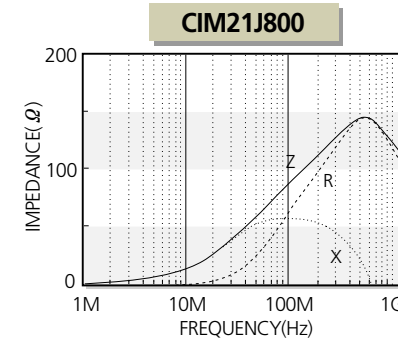
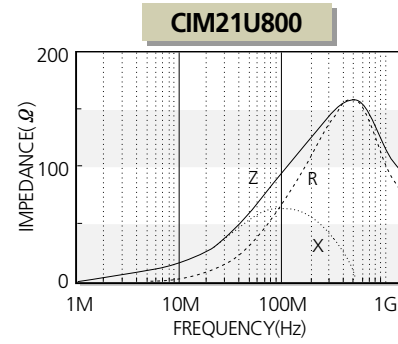
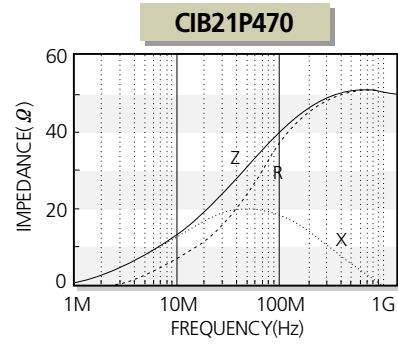
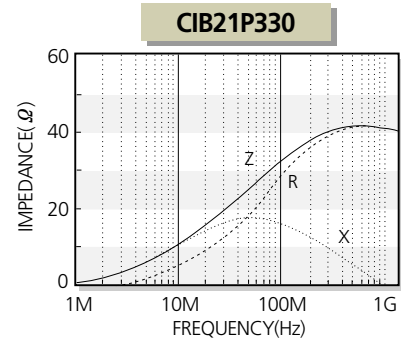
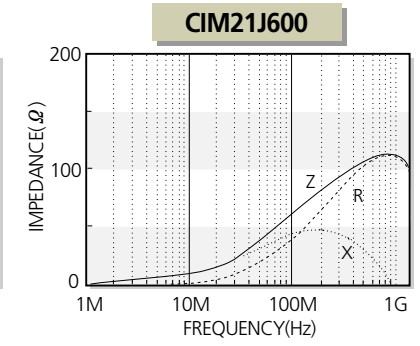
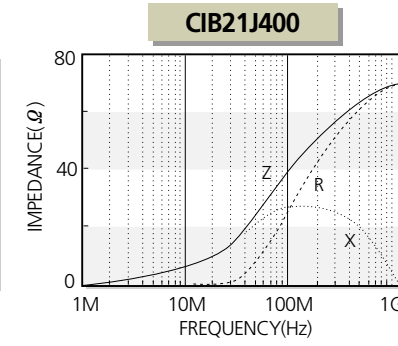
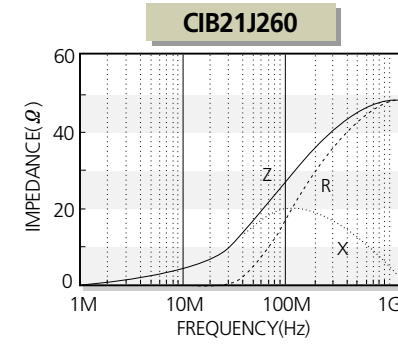
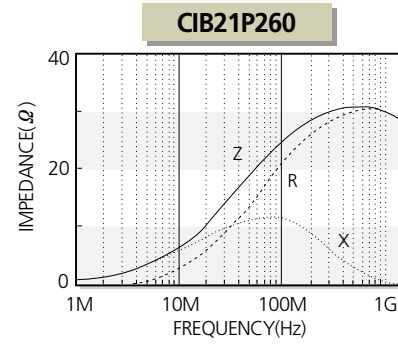
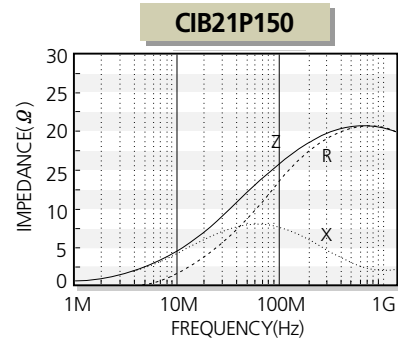
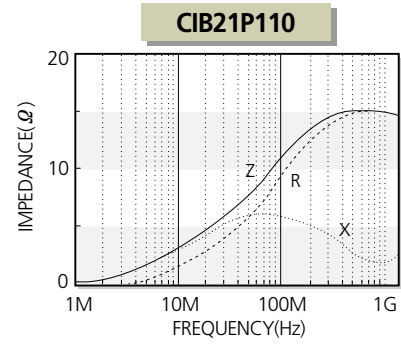

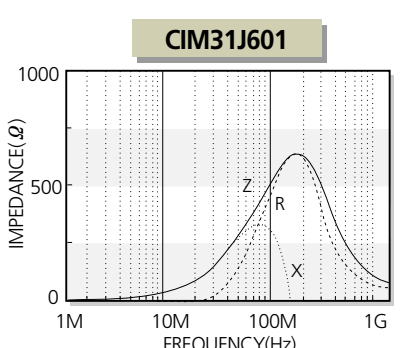
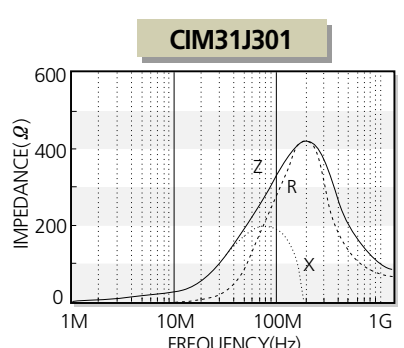
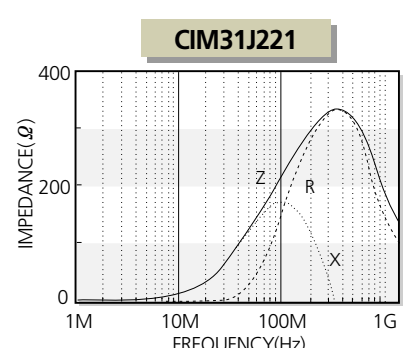
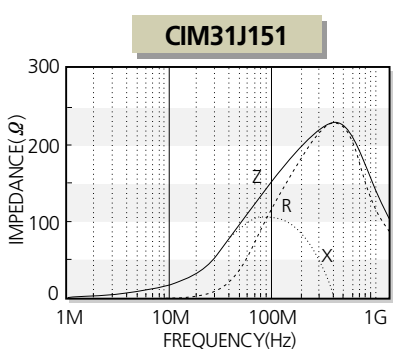
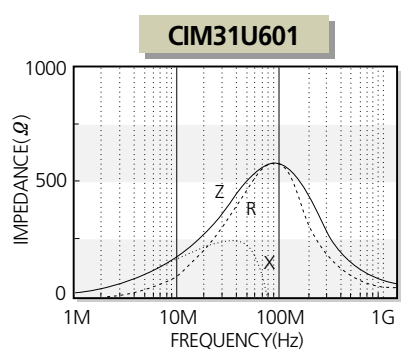
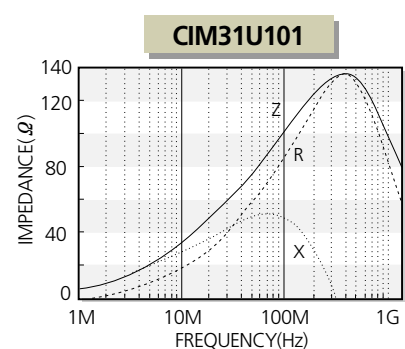
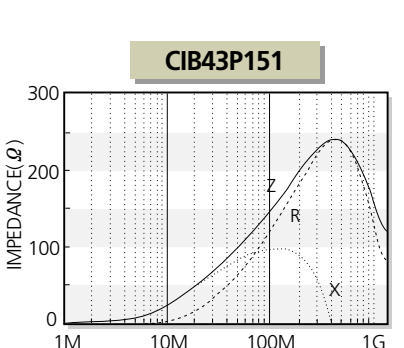
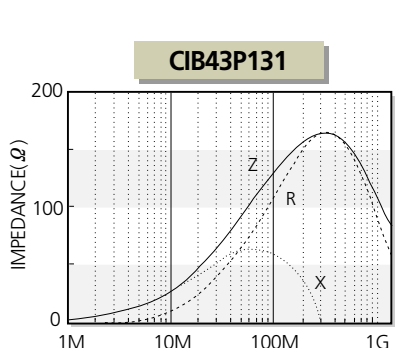
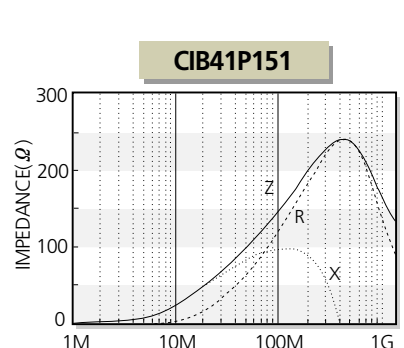
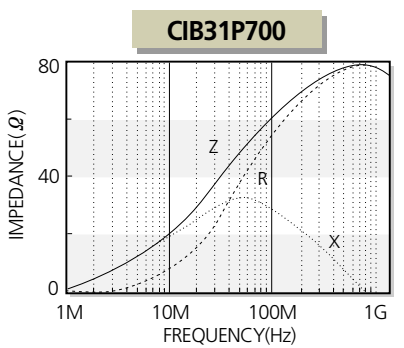
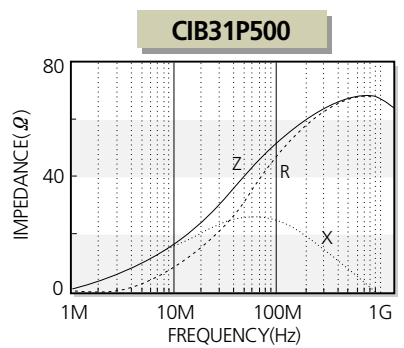
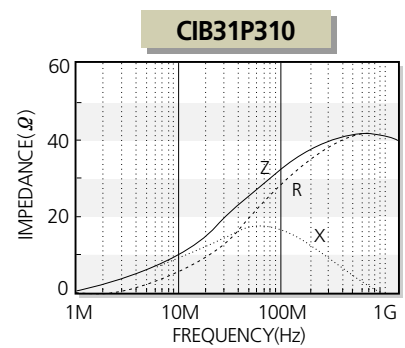
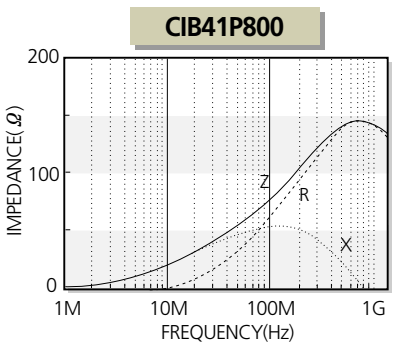
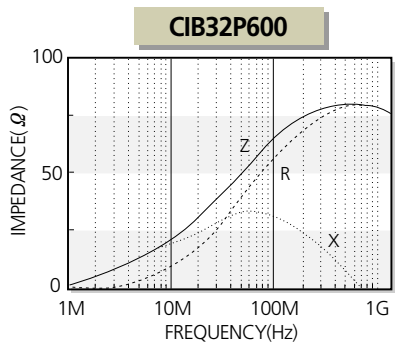
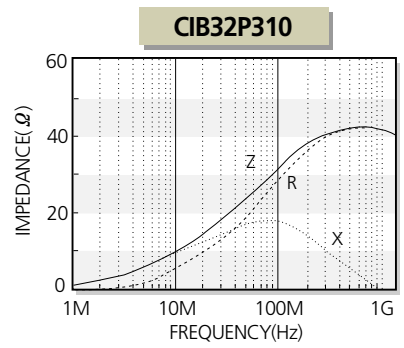
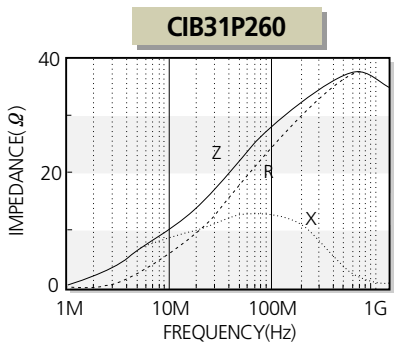
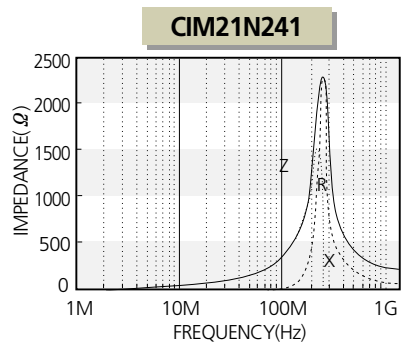
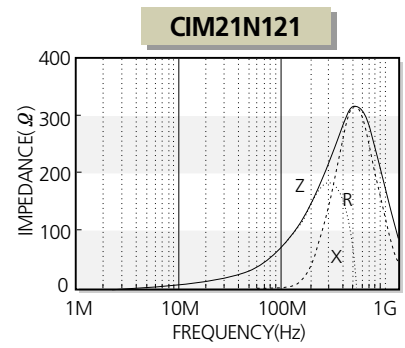
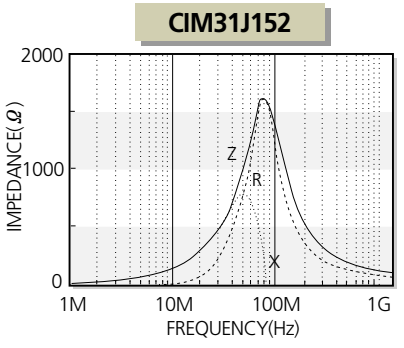
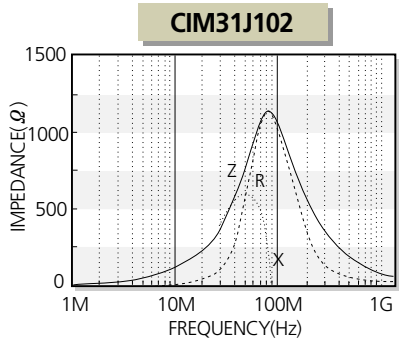
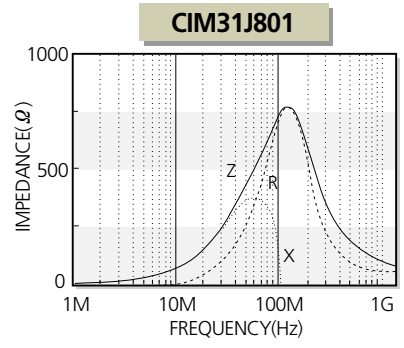
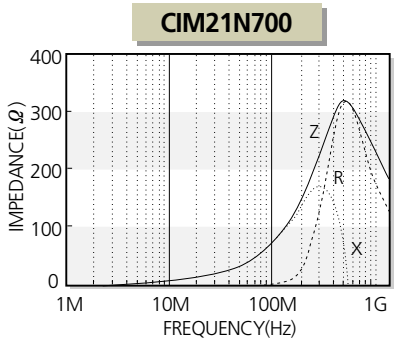
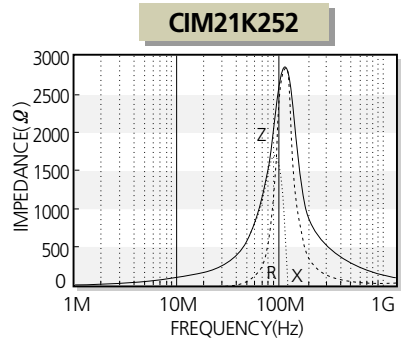
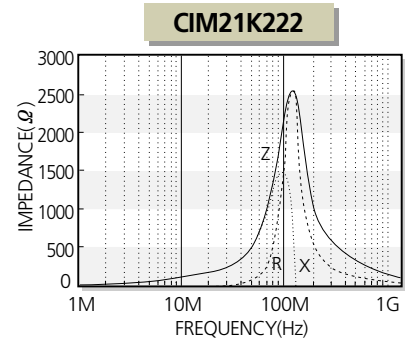

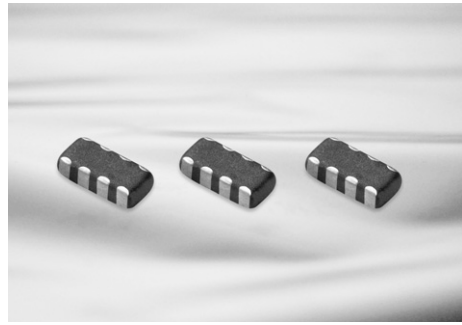

Feature

- Four lines by one chip
- Perfect shape for automatic mounting, with no directionality.
- Excellent solderability and high heat resistance for either flow or reflow soldering.
- Closed magnetic circuit configuration with no cross-talk which is suitable for high density PCBs.

Application

- EMI prevention in Notebook PC, LCD and car navigation
- Ideal for dealing with line noise from multiple signals such as in computer buses.

The CIA Series is an array of ferrite beads used for EMI suppression filters. This series is often used for high density Printed Circuit Boards to save the space and cost. It suppresses electro-magnetic wave noise by increased impedance, especially by increased resistance at noise frequency.

Dimensions

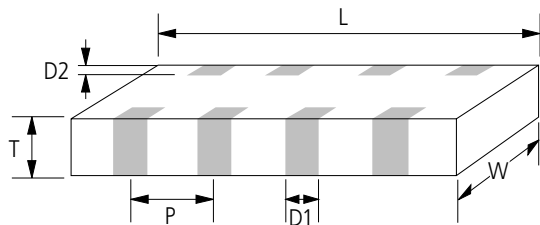

Unit: mm

SIZE CODE	L	W	T	D1	D2	P
31	3.2±0.2	1.6±0.2	0.8±0.2	0.4±0.2	0.3±0.15	0.8±0.1

Part Numbering

C1 A 31 J 121 N E
(1) (2) (3) (4) (5) (6) (7)

- (1) Chip Beads
- (2) A: Bead array
- (3) Dimension
- (4) Material Code
 - U: Broad impedance, especially suppresses noise in the 10~200MHz range
 - J: Suppresses noise in the 100~300MHz range
 - N: Suppresses noise in the 200~500MHz range
- (5) Nominal Impedance (121: 120Ω, 300 : 30Ω)
- (6) Thickness option (N: Standard, A: Thinner than standard, B: Thicker than standard)
- (7) Packaging (C: paper tape, E: embossed tape)

CIA 3216 (1206) Type

Part No.	Thickness (mm)	Impedance (Ω) ±25% @ 100 MHz	DC Resistance (Ω) Max.	Rated Current (mA) Max.
CIA 31U 300	0.8±0.2	30	0.10	200
CIA 31U 600	0.8±0.2	60	0.15	150
CIA 31U 800	0.8±0.2	80	0.20	150
CIA 31U 121	0.8±0.2	120	0.20	150
CIA 31U 221	0.8±0.2	220	0.40	150
CIA 31U 241	0.8±0.2	240	0.40	150
CIA 31U 301	0.8±0.2	300	0.40	150
CIA 31U 471	0.8±0.2	470	0.50	150
CIA 31U 601	0.8±0.2	600	0.70	100
CIA 31U 102	0.8±0.2	1000	0.80	50
CIA 31J 300	0.8±0.2	30	0.10	200
CIA 31J 600	0.8±0.2	60	0.15	150
CIA 31J 800	0.8±0.2	80	0.20	150
CIA 31J 121	0.8±0.2	120	0.20	150
CIA 31J 221	0.8±0.2	220	0.40	150
CIA 31J 241	0.8±0.2	240	0.40	150
CIA 31J 301	0.8±0.2	300	0.40	150
CIA 31J 471	0.8±0.2	470	0.50	150
CIA 31J 601	0.8±0.2	600	0.70	100
CIA 31J 102	0.8±0.2	1000	0.80	50
CIA 31N 800	0.8±0.2	80	0.35	200
CIA 31N 121	0.8±0.2	120	0.55	200
CIA 31N 241	0.8±0.2	240	0.85	150

Customized products are available.
Test equipment : Agilent 4291B+16192A

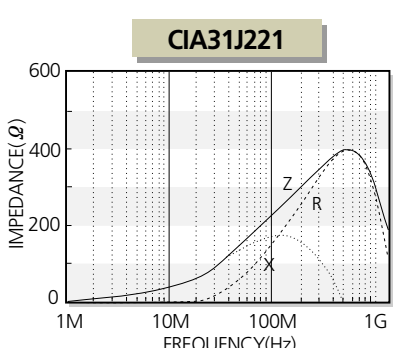
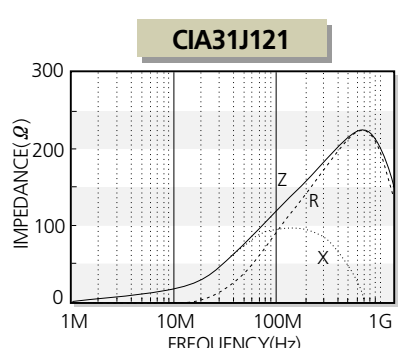
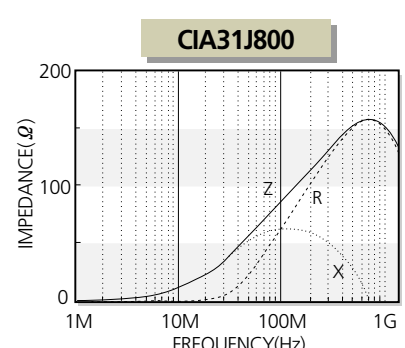
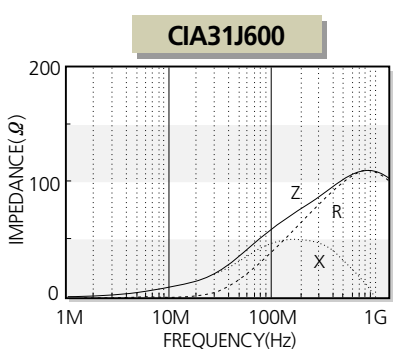
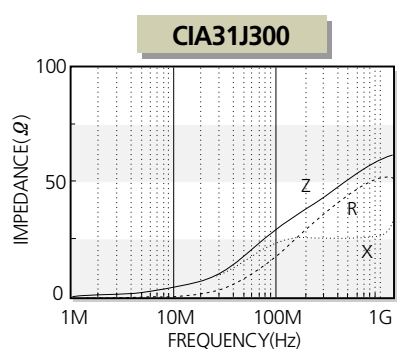
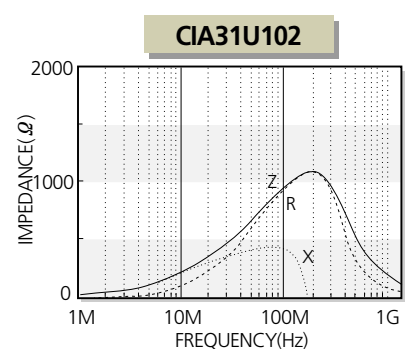
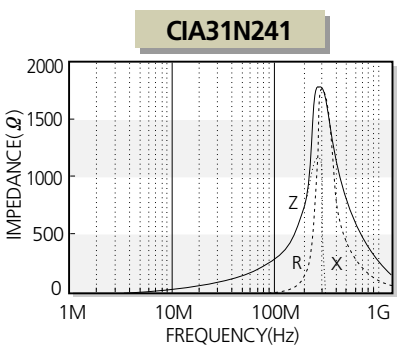
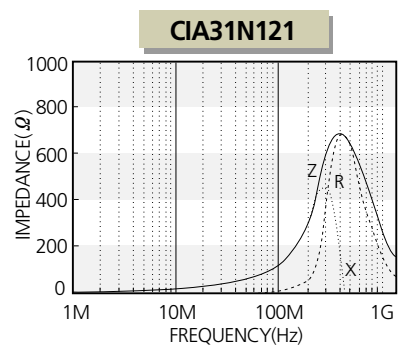
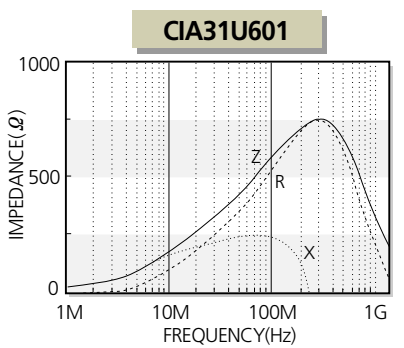
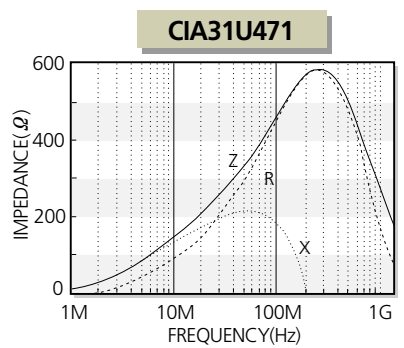
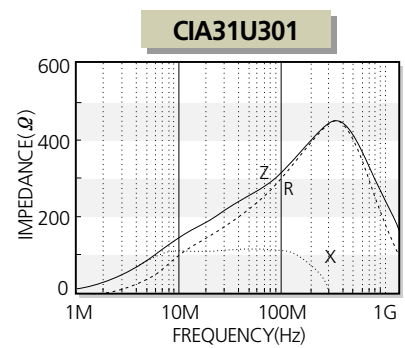
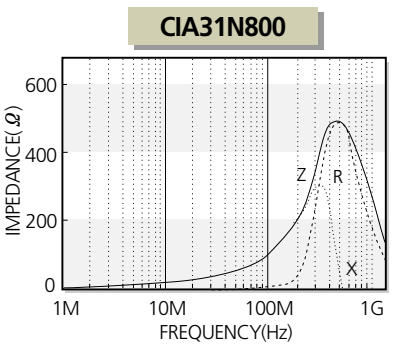
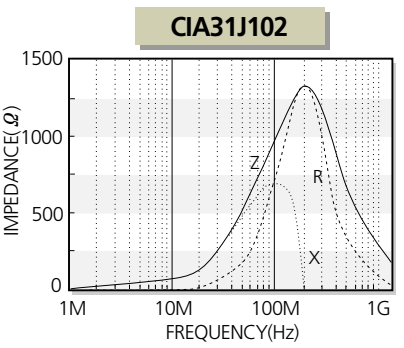
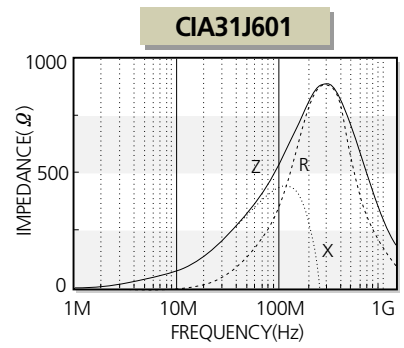
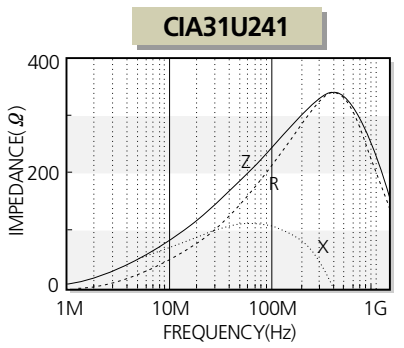
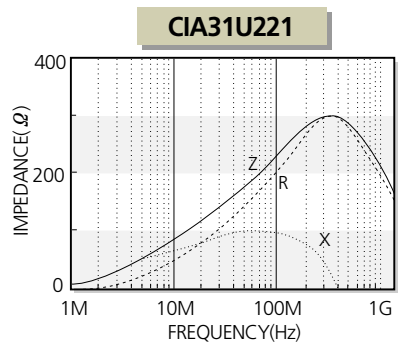
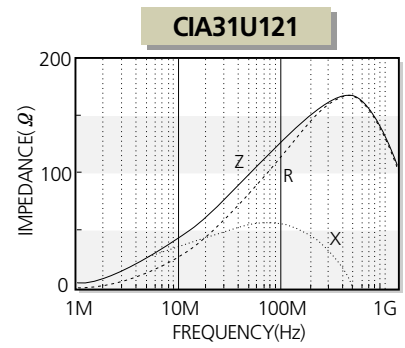
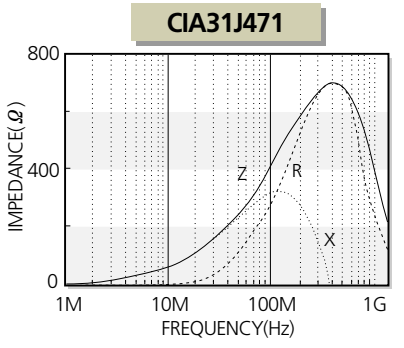
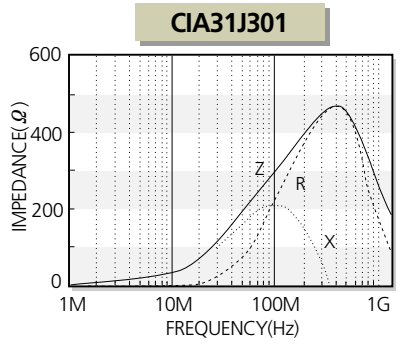
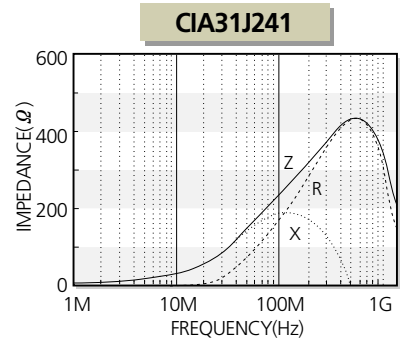
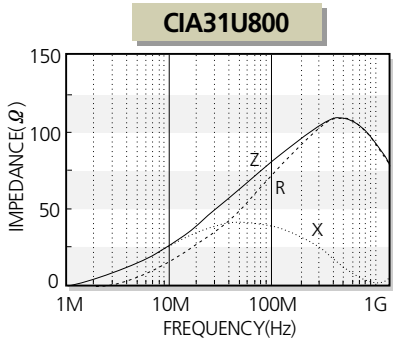
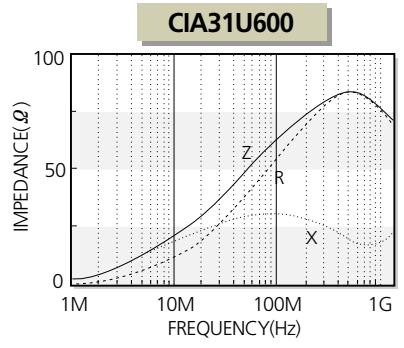
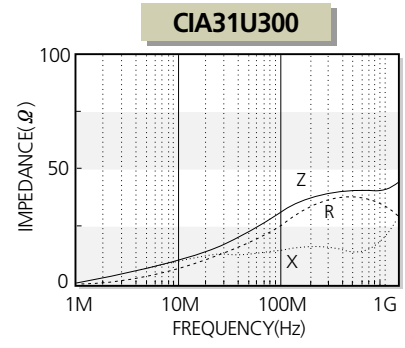

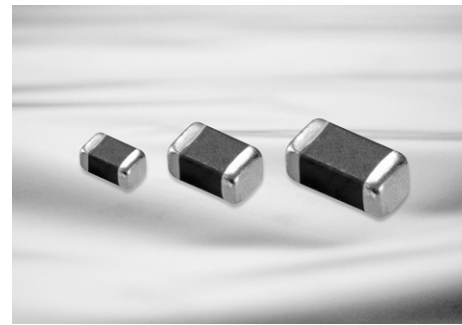

Feature

- The smallest beads used for high current.
(CIC: ~3A, CIS: ~6A)

Application

- Suppression of noise in power line

The CIC/CIS Series can be used in high current owing to their low DC resistance. They can match power lines to a maximum of 6A DC.

Dimensions

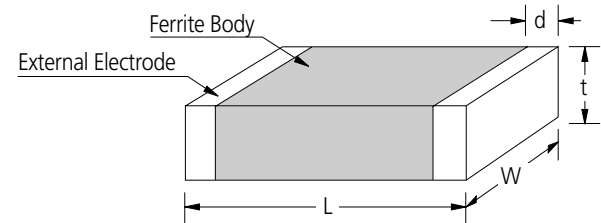

Unit : mm

SIZE CODE	L	W	t	d
05	1.0±0.05	0.5±0.05	0.5±0.05	0.25±0.1
10	1.6±0.15	0.8±0.15	0.8±0.15	0.3±0.2
21	2.0±0.2	1.25±0.2	0.9±0.2	0.5+0.2,-0.3
31	3.2±0.2	1.6±0.2	1.1±0.2	0.5+0.2,-0.3
32	3.2±0.2	2.5±0.2	1.3±0.2	0.5±0.3
41	4.5±0.2	1.6±0.2	1.6±0.2/1.2±0.2	0.5±0.3
43	4.5±0.2	3.2±0.2	1.5±0.2	0.5±0.3

Part Numbering

CI C 05 P 300 N C
(1) (2) (3) (4) (5) (6) (7)

- (1) Chip Beads
- (2) C: For high current ~3A, S: Ultra high current ~6A
- (3) Dimension
- (4) Material Code(J, P)
- (5) Nominal impedance(310: 31Ω, 121: 120Ω)
- (6) Thickness option(N: Standard, A: Thinner than standard, B: Thicker than standard)
- (7) Packaging(C: paper tape, E: embossed tape)

CIC 1005(0402) Type

Part No.	Thickness (mm)	Impedance (Ω)±25% @ 100 MHz	DC Resistance (Ω) Max.	Rated Current (mA) Max.
CIC 05P 300	0.50±0.05	30	0.05	1500
CIC 05P 600	0.50±0.05	60	0.09	1500
CIC 05P 121	0.50±0.05	120	0.09	1500
CIC 05J 600	0.50±0.05	60	0.09	1500

CIC 1608(0603) Type

Part No.	Thickness (mm)	Impedance (Ω)±25% @ 100 MHz	DC Resistance (Ω) Max.	Rated Current (mA) Max.
CIC 10P 080	0.80±0.15	8	0.02	3000
CIC 10P 220	0.80±0.15	22	0.025	3000
CIC 10P 300	0.80±0.15	30	0.025	3000
CIC 10P 600	0.80±0.15	60	0.05	2000
CIC 10P 121	0.80±0.15	120	0.05	2000
CIC 10P 181	0.80±0.15	180	0.09	1500
CIC 10P 221	0.80±0.15	220	0.09	1000
CIC 10P 301	0.80±0.15	300	0.15	750
CIC 10P 331	0.80±0.15	330	0.15	1200
CIC 10J 080	0.80±0.15	8	0.02	3000
CIC 10J 300	0.80±0.15	30	0.03	2000
CIC 10J 600	0.80±0.15	60	0.05	2000
CIC 10J 121	0.80±0.15	120	0.05	2000
CIC 10J 221	0.80±0.15	220	0.10	1500
CIC 10J 301	0.80±0.15	300	0.15	800
CIC 10J 471	0.80±0.15	470	0.15	800
CIC 10J 601	0.80±0.15	600	0.15	750

CIC 2012(0805) Type

Part No.	Thickness (mm)	Impedance (Ω)±25% @ 100 MHz	DC Resistance (Ω) Max.	Rated Current (mA) Max.
CIC 21P 110	0.90±0.2	11	0.01	6000
CIC 21P 300	0.90±0.2	30	0.015	3000
CIC 21P 600	0.90±0.2	60	0.025	3000
CIC 21P 101	0.90±0.2	100	0.04	2000
CIC 21P 121	0.90±0.2	120	0.05	2000
CIC 21P 221	0.90±0.2	220	0.05	2000
CIC 21J 600	0.90±0.2	60	0.03	2500
CIC 21J 121	0.90±0.2	120	0.05	2500
CIC 21J 221	0.90±0.2	220	0.05	1500
CIC 21J 301	0.90±0.2	300	0.10	1500
CIC 21J 471	0.90±0.2	470	0.08	1500
CIC 21J 60	0.90±0.2	600	0.15	1000

CIC 3216(1206) Type

Part No.	Thickness (mm)	Impedance (Ω) \pm 25% @ 100 MHz	DC Resistance (Ω) Max.	Rated Current (mA) Max.
CIC 31P 300	1.1 \pm 0.2	30	0.01	6000
CIC 31P 500	1.1 \pm 0.2	50	0.025	3000
CIC 31P 700	1.1 \pm 0.2	70	0.025	3000
CIC 31P 121	1.1 \pm 0.2	120	0.025	2000
CIC 31P 221	1.1 \pm 0.2	220	0.05	2000
CIC 31P 301	1.1 \pm 0.2	300	0.05	2000
CIC 31P 471	1.1 \pm 0.2	470	0.07	1500
CIC 31P 601	1.1 \pm 0.2	600	0.15	1000
CIC 31J 300	1.1 \pm 0.2	30	0.02	4000
CIC 31J 500	1.1 \pm 0.2	50	0.02	4000
CIC 31J 800	1.1 \pm 0.2	80	0.02	4000
CIC 31J 121	1.1 \pm 0.2	120	0.03	4000
CIC 31J 241	1.1 \pm 0.2	240	0.05	3000
CIC 31J 301	1.1 \pm 0.2	300	0.05	3000
CIC 31J 471	1.1 \pm 0.2	470	0.05	3000
CIC 31J 601	1.1 \pm 0.2	600	0.05	2500

CIC 4516(1806) Type

Part No.	Thickness (mm)	Impedance (Ω) \pm 25% @ 100 MHz	DC Resistance (Ω) Max.	Rated Current (mA) Max.
CIC 41P 600	1.6 \pm 0.2	60	0.01	6000
CIC 41P 800	1.6 \pm 0.2	80	0.01	6000
CIC 41P 121	1.6 \pm 0.2	120	0.025	3000
CIC 41P 221	1.6 \pm 0.2	220	0.05	2000
CIC 41P 301	1.6 \pm 0.2	300	0.05	2000
CIC 41P 471	1.6 \pm 0.2	470	0.05	2000
CIC 41P 601	1.6 \pm 0.2	600	0.08	1500
CIC 41J 400	1.6 \pm 0.2	40	0.01	6000
CIC 41J 800	1.6 \pm 0.2	80	0.01	6000
CIC 41J 121	1.6 \pm 0.2	120	0.03	3000
CIC 41J 221	1.6 \pm 0.2	220	0.04	2500
CIC 41J 301	1.6 \pm 0.2	300	0.04	2500
CIC 41J 471	1.6 \pm 0.2	470	0.04	2500
CIC 41J 601	1.6 \pm 0.2	600	0.04	2500

CIC 4532(1812) Type

Part No.	Thickness (mm)	Impedance (Ω) \pm 25% @ 100 MHz	DC Resistance (Ω) Max.	Rated Current (mA) Max.
CIC 43P 300	1.5 \pm 0.2	30	0.03	3000
CIC 43P 700	1.5 \pm 0.2	70	0.03	3000
CIC 43P 121	1.5 \pm 0.2	120	0.03	3000
CIC 43P 221	1.5 \pm 0.2	220	0.05	2000
CIC 43P 301	1.5 \pm 0.2	300	0.05	2000
CIC 43P 471	1.5 \pm 0.2	470	0.05	2000
CIC 43P 601	1.5 \pm 0.2	600(at 50MHz)	0.05	3000
CIC 43J 300	1.5 \pm 0.2	30	0.02	3000
CIC 43J 121	1.5 \pm 0.2	120	0.03	3000
CIC 43J 301	1.5 \pm 0.2	300	0.04	3000
CIC 43J 471	1.5 \pm 0.2	470	0.04	3000
CIC 43J 601	1.5 \pm 0.2	600	0.04	3000

CIS Series

Part No.	Thickness (mm)	Impedance (Ω) \pm 25% @ 100 MHz	DC Resistance (Ω) Max.	Rated Current (mA) Max.
CIS 10J 300	0.8 \pm 0.15	30	0.01	6000
CIS 21P 300	0.9 \pm 0.2	30	0.01	5000
CIS 21J 121	0.9 \pm 0.2	120	0.02	5000
CIS 32P 520	1.3 \pm 0.2	52	0.01	6000
CIS 32J 121	1.3 \pm 0.2	120	0.02	5000
CIS 41P 600	1.6 \pm 0.2	60	0.01	6000
CIS 41J 600	1.6 \pm 0.2	60	0.01	6000
CIS 43P 241	1.5 \pm 0.2	240	0.02	6000

Customized products are available.
 Test equipment : Agilent 4291B+16192A (1005)
 Agilent 4291B+16193A (1608 and others)

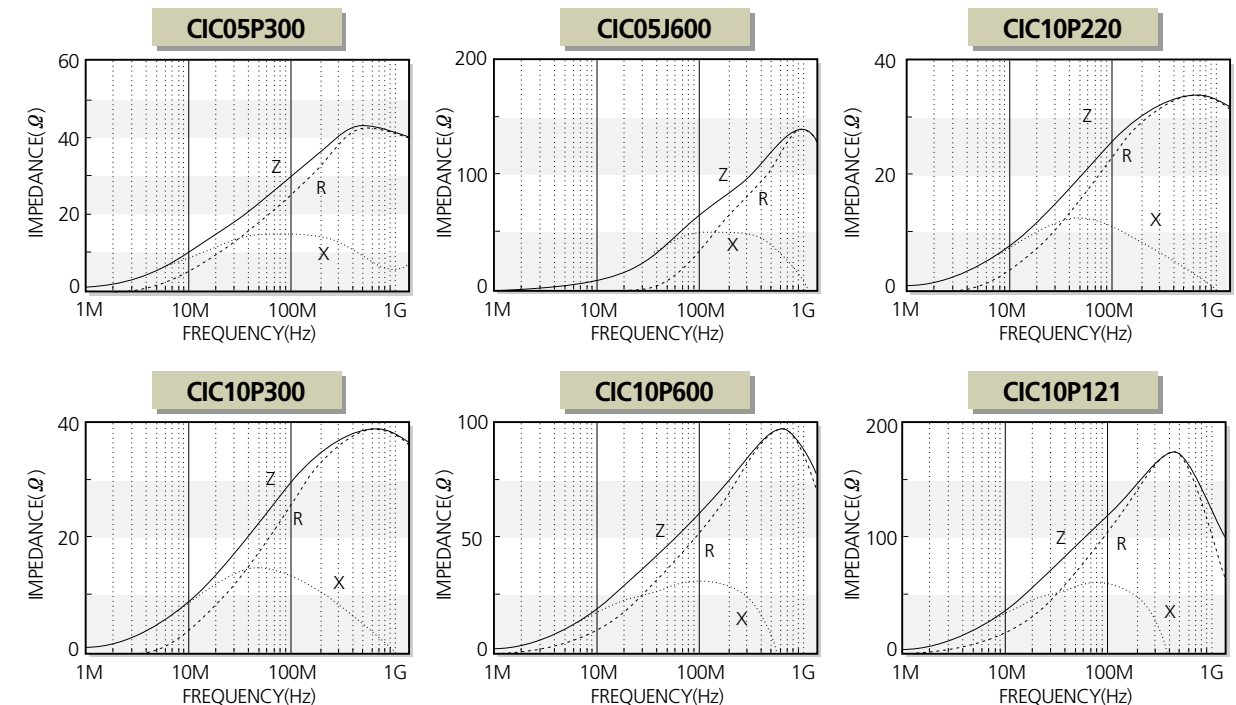

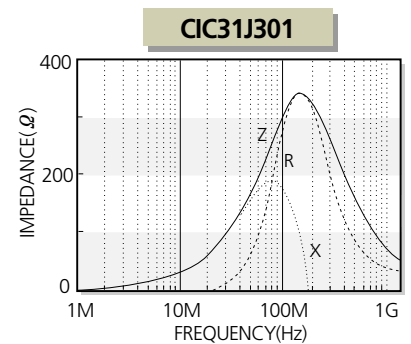
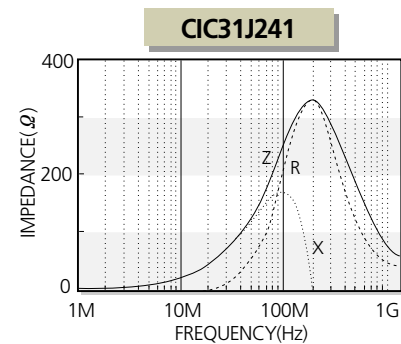
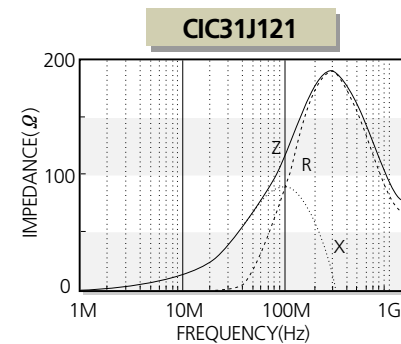
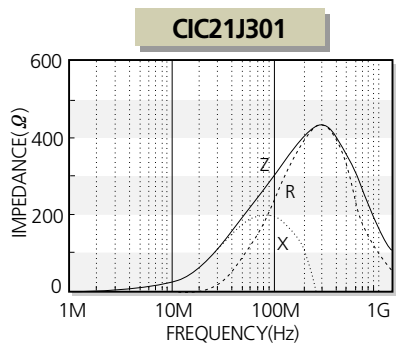
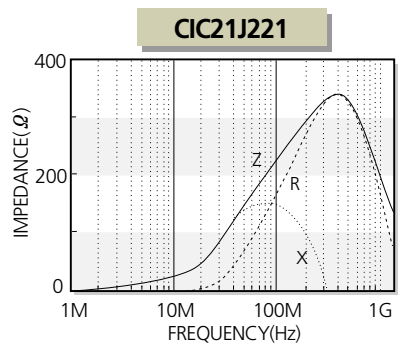
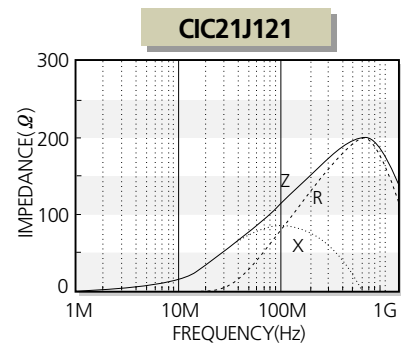
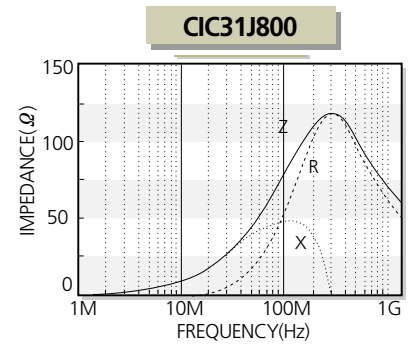
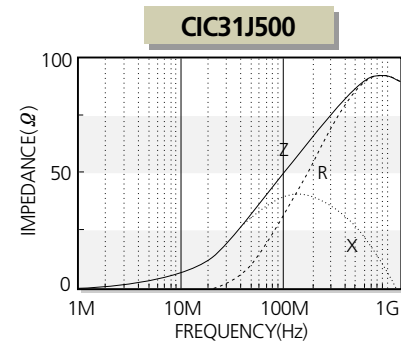
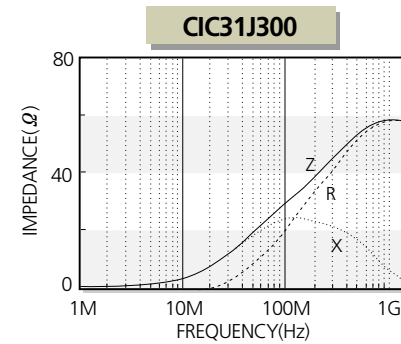
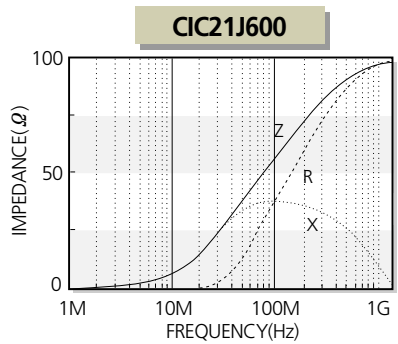
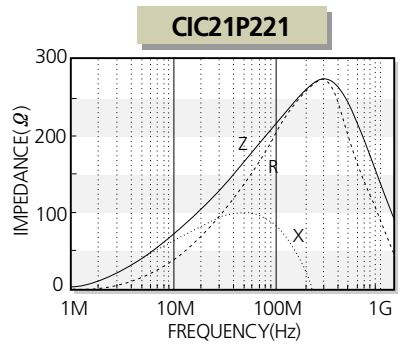
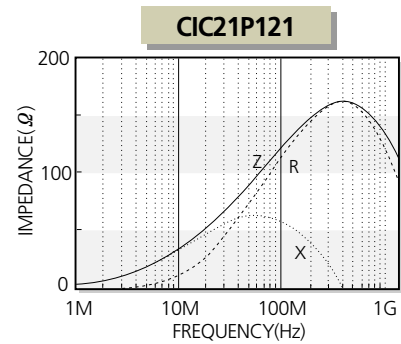
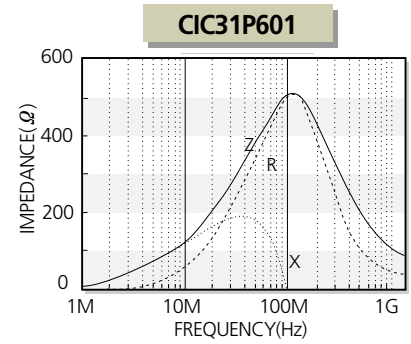
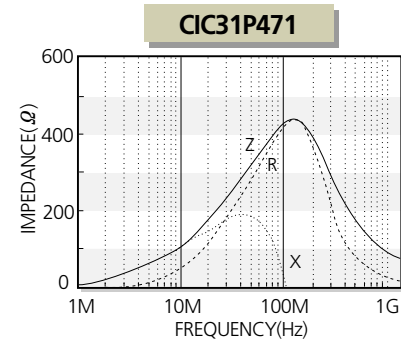
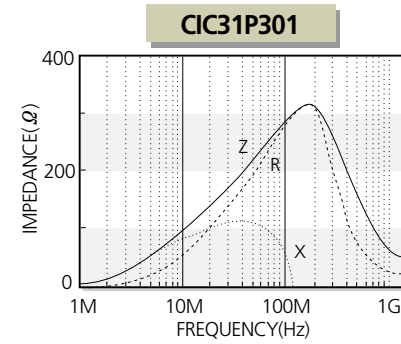
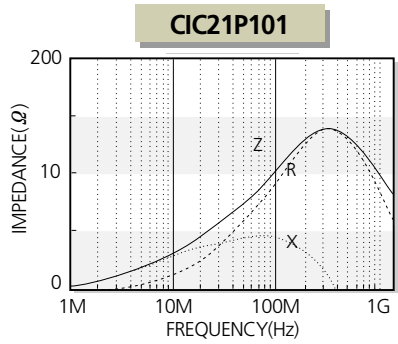
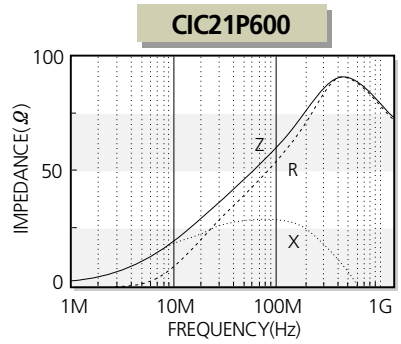
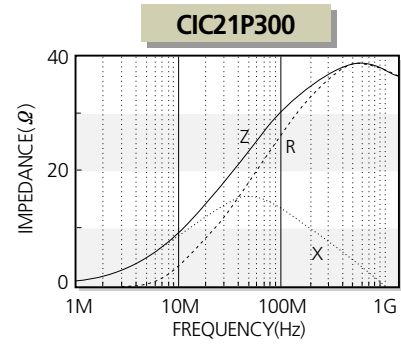
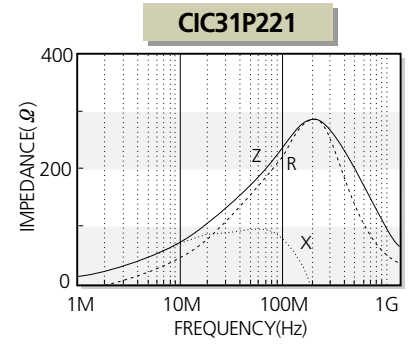
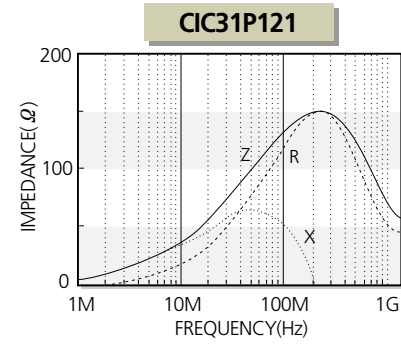
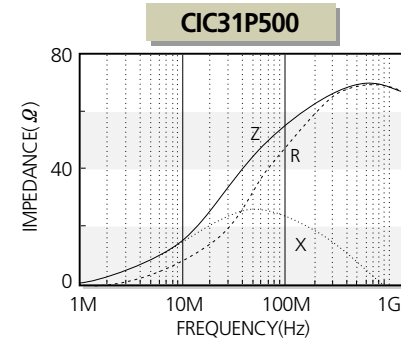
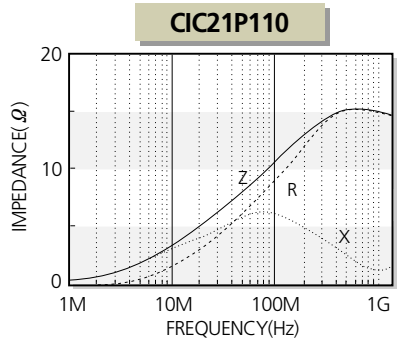
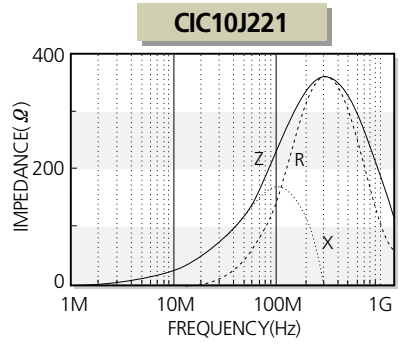
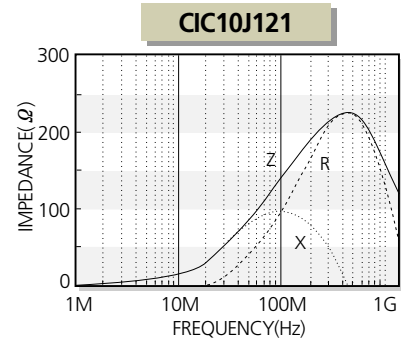
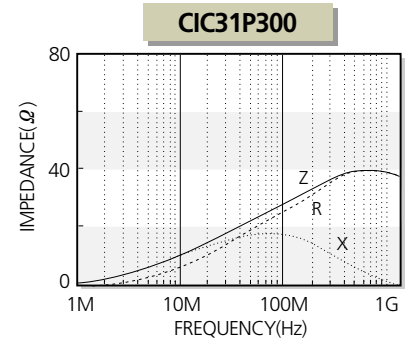
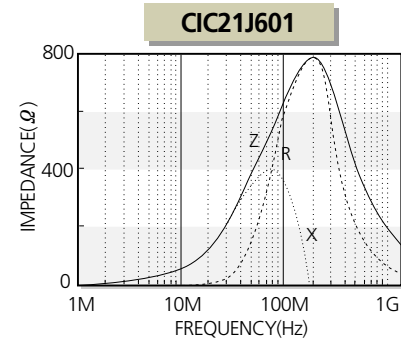
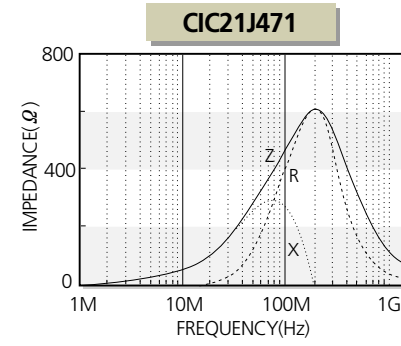
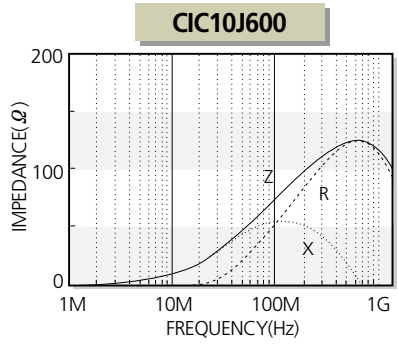
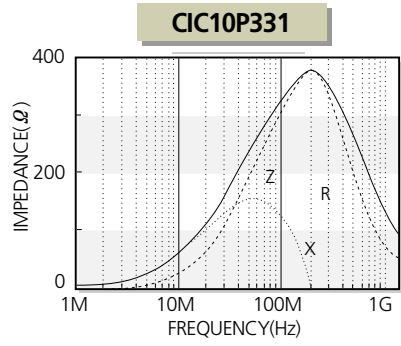
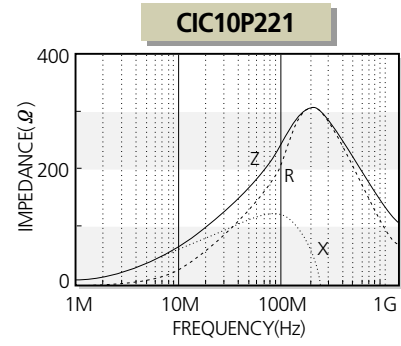

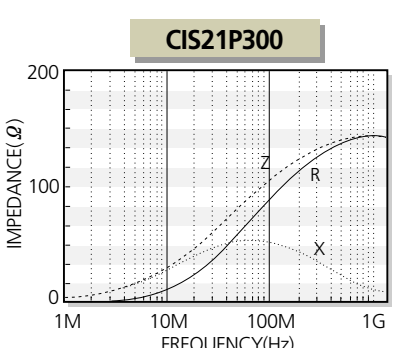
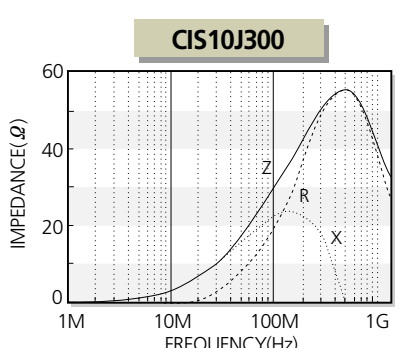
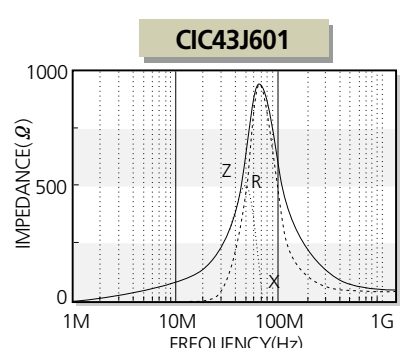
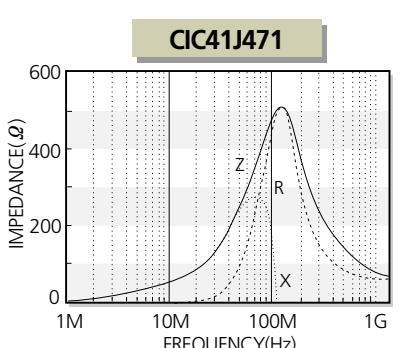
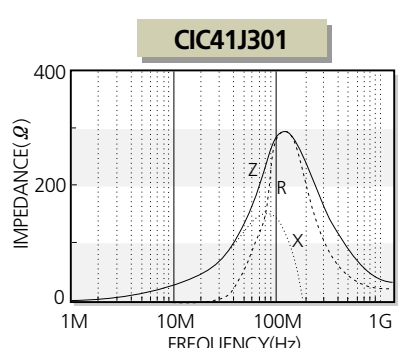
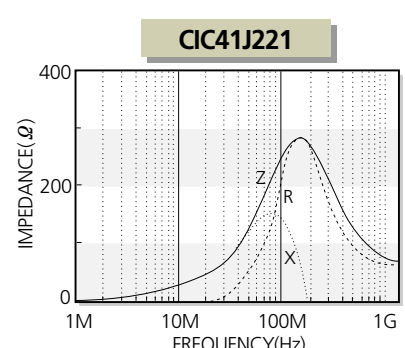
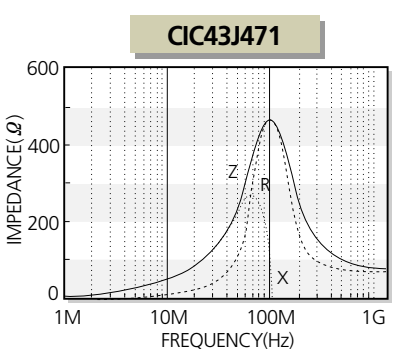
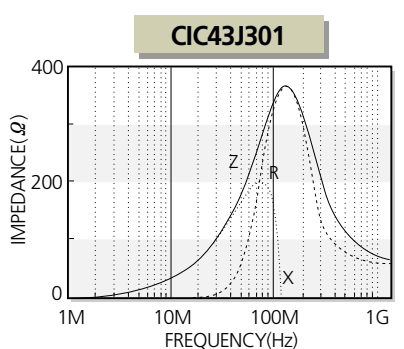
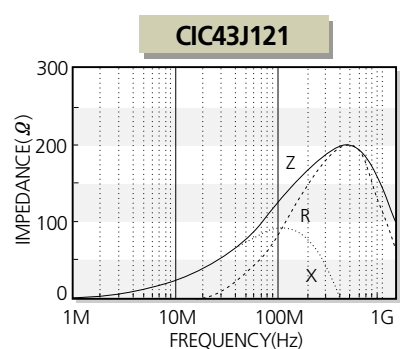
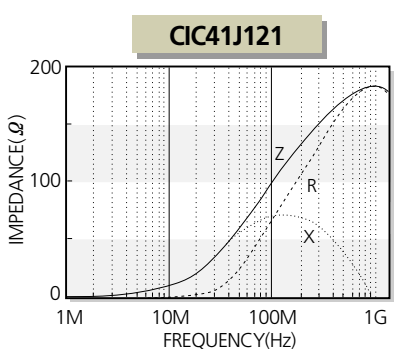
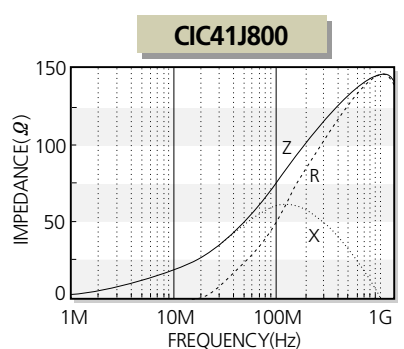
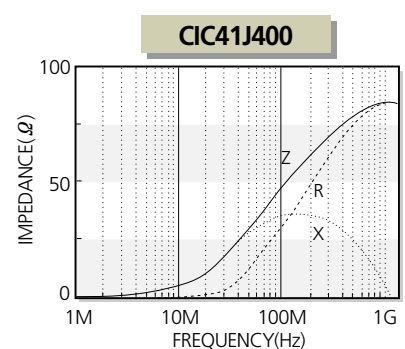
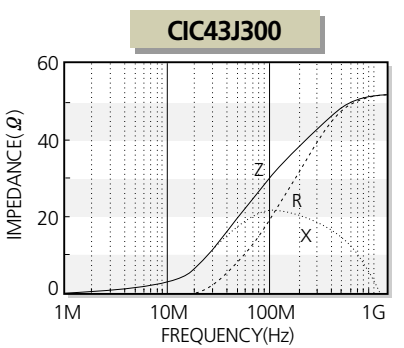
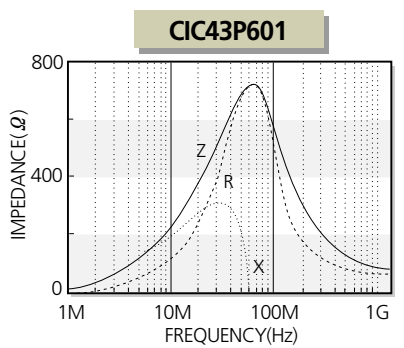
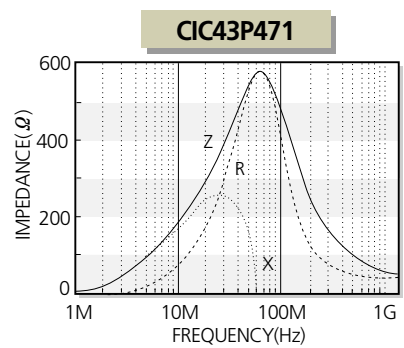
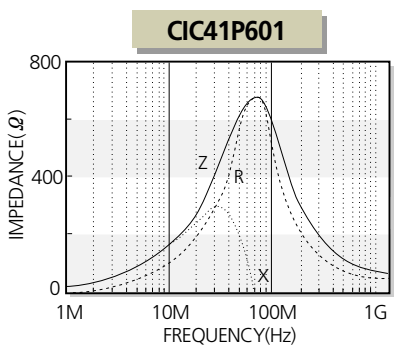
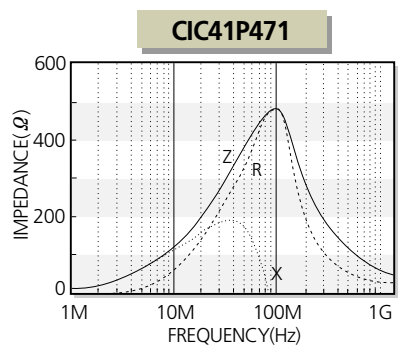
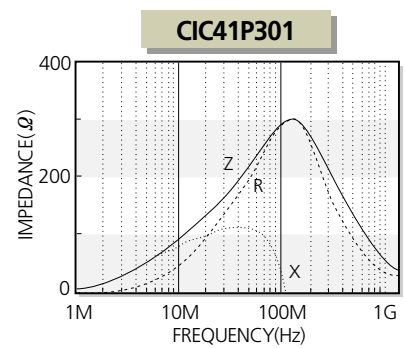
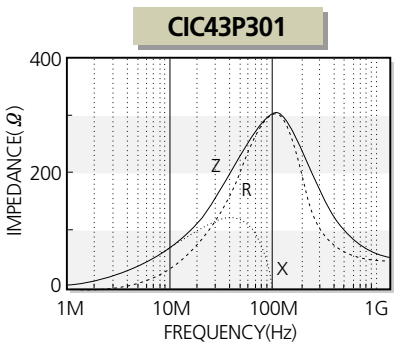
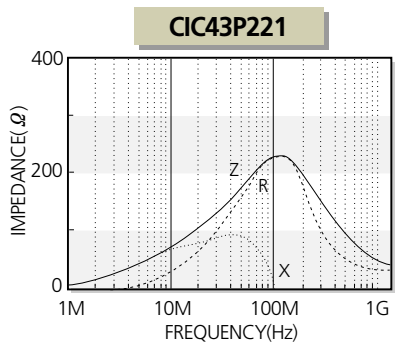
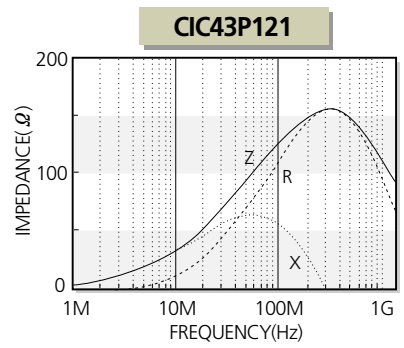
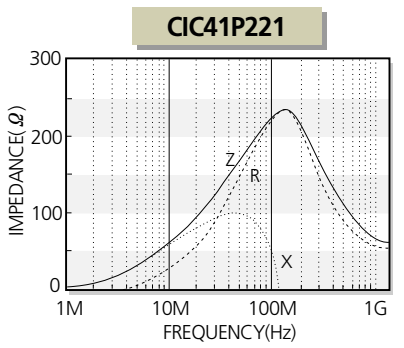
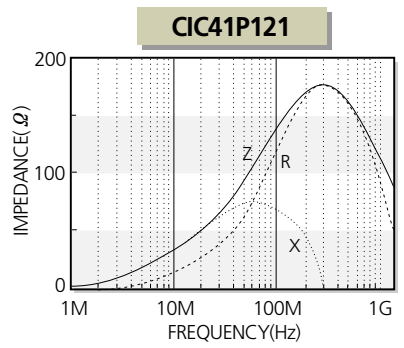
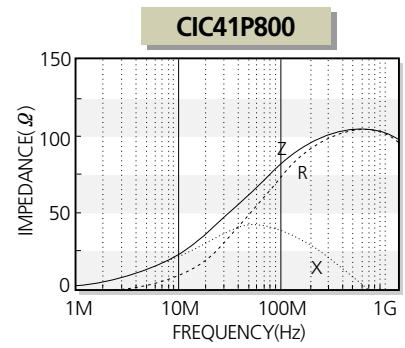
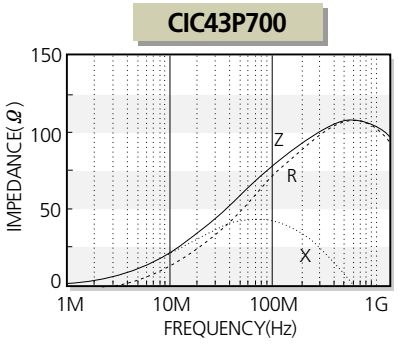
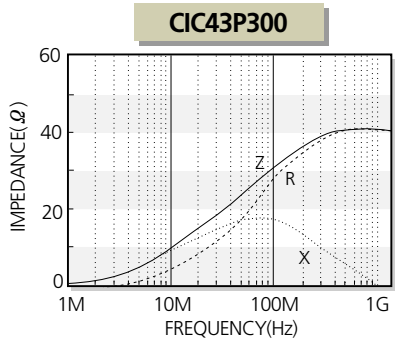
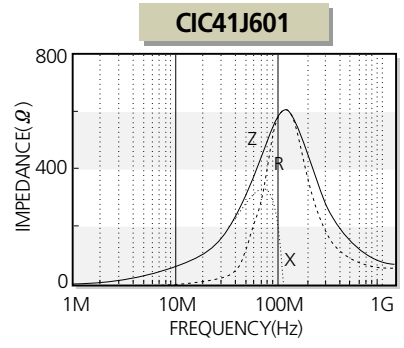
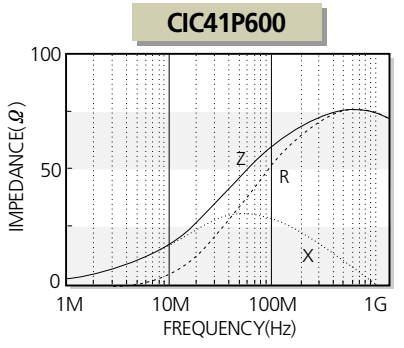
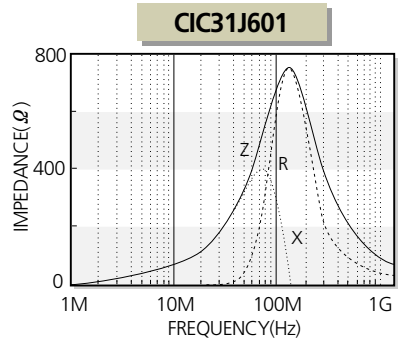
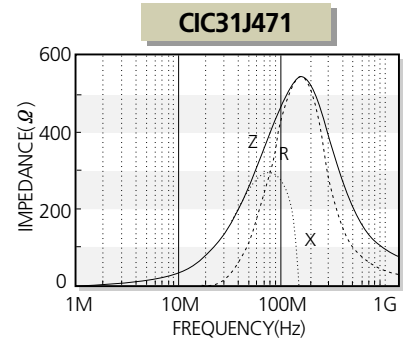

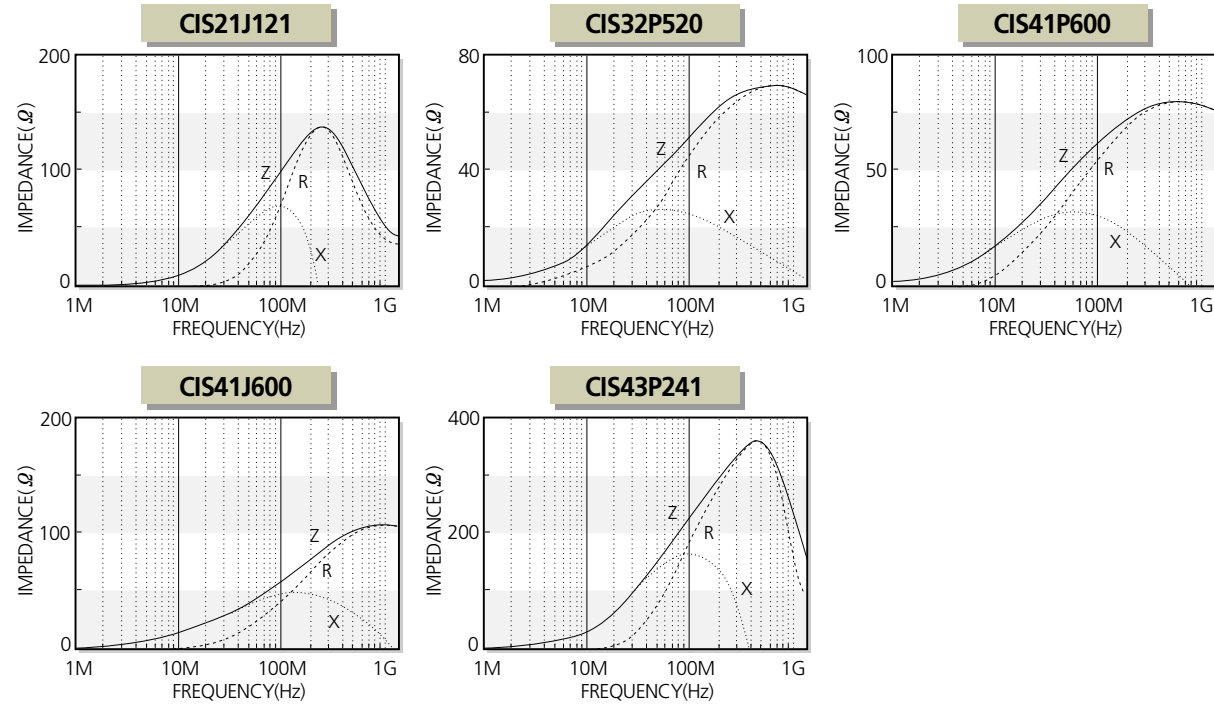

Feature

- Magnetic shielding eliminates crosstalk, thus permitting higher mounting density.
- Excellent solderability and high heat resistance for either flow or reflow soldering.
- Monolithic structure for high reliability.

Application

- Resonance circuits, PLL circuits, Noise suppression, etc.

As it has ferrite body and 100 % Ag internal conductor, the CIL series Inductors have excellent Q characteristics and free of cross talk.

Dimensions

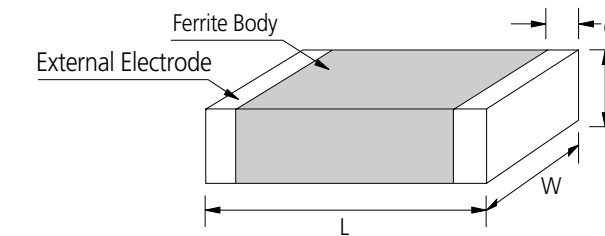

Unit : mm

SIZE CODE	L	W	T	d
10	1.6±0.15	0.8±0.15	0.8±0.15	0.3±0.2
21	2.0±0.2	1.25±0.2	0.85±0.2 1.25±0.2	0.5+0.2,-0.3
31	3.2±0.2	1.6±0.2	0.6±0.2 1.1±0.2	0.5+0.2,-0.3

Part Numbering

CI L 10 Y 5R6 K N C
 (1) (2) (3) (4) (5) (6) (7) (8)

- (1) Chip Inductor
- (2) L: Ordinary type
- (3) Dimension
- (4) Material code (N, J, Y, S)
- (5) Inductance (R10: 0.1μH, 5R6: 5.6μH, 100: 10μH)
- (6) Tolerance (K: ±10%, M: ±20%)
- (7) Thickness option (N: Standard, A: Thinner than standard, B: Thicker than standard)
- (8) Packaging (C: paper tape, E: embossed tape)

CIL Series

CIL 1608(0603) Type

Part No.	Thickness (mm)	Inductance (μH)	Q Min.	L, Q test frequency (MHZ)	SRF (MHZ) Min.	DC resistance (Ω) Max.	Rated current (mA) Max.
CIL 10N 47N □	0.80±0.15	0.047±20%, 10%	10	50	260	0.30	50
CIL 10N 56N □	0.80±0.15	0.056±20%, 10%	10	50	260	0.30	50
CIL 10N 68N □	0.80±0.15	0.068±20%, 10%	10	50	250	0.30	50
CIL 10N 82N □	0.80±0.15	0.082±20%, 10%	10	50	245	0.30	50
CIL 10N R10 □	0.80±0.15	0.10±20%, 10%	15	25	240	0.50	50
CIL 10N R12 □	0.80±0.15	0.12±20%, 10%	15	25	205	0.50	50
CIL 10N R15 □	0.80±0.15	0.15±20%, 10%	15	25	180	0.60	50
CIL 10N R18 □	0.80±0.15	0.18±20%, 10%	15	25	165	0.60	50
CIL 10N R22 □	0.80±0.15	0.22±20%, 10%	15	25	150	0.80	50
CIL 10N R27 □	0.80±0.15	0.27±20%, 10%	15	25	136	0.80	50
CIL 10N R33 □	0.80±0.15	0.33±20%, 10%	15	25	125	0.85	35
CIL 10N R39 □	0.80±0.15	0.39±20%, 10%	15	25	110	1.00	35
CIL 10N R47 □	0.80±0.15	0.47±20%, 10%	15	25	105	1.35	35
CIL 10N R56 □	0.80±0.15	0.56±20%, 10%	15	25	95	1.55	35
CIL 10N R68 □	0.80±0.15	0.68±20%, 10%	15	25	80	1.70	35
CIL 10N R82 □	0.80±0.15	0.82±20%, 10%	15	25	75	2.10	35
CIL 10J 1R0 □	0.80±0.15	1.0±20%, 10%	35	10	70	0.60	25
CIL 10J 1R2 □	0.80±0.15	1.2±20%, 10%	35	10	60	0.80	25
CIL 10J 1R5 □	0.80±0.15	1.5±20%, 10%	35	10	55	0.80	25
CIL 10J 1R8 □	0.80±0.15	1.8±20%, 10%	35	10	50	0.95	25
CIL 10J 2R2 □	0.80±0.15	2.2±20%, 10%	35	10	45	1.15	15
CIL 10J 2R7 □	0.80±0.15	2.7±20%, 10%	35	10	40	1.35	15
CIL 10J 3R3 □	0.80±0.15	3.3±20%, 10%	35	10	38	1.55	15
CIL 10J 3R9 □	0.80±0.15	3.9±20%, 10%	35	10	36	1.70	15
CIL 10J 4R7 □	0.80±0.15	4.7±20%, 10%	35	10	33	2.10	15
CIL 10Y 5R6 □	0.80±0.15	5.6±20%, 10%	35	4	22	1.55	5
CIL 10Y 6R8 □	0.80±0.15	6.8±20%, 10%	35	4	20	1.70	5
CIL 10Y 8R2 □	0.80±0.15	8.2±20%, 10%	35	4	18	2.10	5
CIL 10Y 100 □	0.80±0.15	10.0±20%, 10%	35	2	17	2.55	5
CIL 10Y 120 □	0.80±0.15	12.0±20%, 10%	35	2	15	2.75	5
CIL 10S 150 □	0.80±0.15	15.0±20%, 10%	20	1	14	1.70	1
CIL 10S 180 □	0.80±0.15	18.0±20%, 10%	20	1	13	1.85	1
CIL 10S 220 □	0.80±0.15	22.0±20%, 10%	20	1	11	2.10	1
CIL 10S 270 □	0.80±0.15	27.0±20%, 10%	20	1	10	2.75	1
CIL 10S 330 □	0.80±0.15	33.0±20%, 10%	20	0.4	9	2.95	1

□: Tolerance (K: ±10%, M: ±20%)
* Test equipment: Agilent 4291B+16193A

CIL 2012(0805) Type

Part No.	Thickness (mm)	Inductance (μH)	Q Min.	L, Q test frequency (MHZ)	SRF (MHZ) Min.	DC resistance (Ω) Max.	Rated current (mA) Max.
CIL 21N 47N □	0.85±0.2	0.047±20%, 10%	15	50	320	0.20	300
CIL 21N 68N □	0.85±0.2	0.068±20%, 10%	15	50	280	0.20	300
CIL 21N 82N □	0.85±0.2	0.082±20%, 10%	15	50	255	0.20	300
CIL 21N R10 □	0.85±0.2	0.10±20%, 10%	20	25	235	0.30	250
CIL 21N R12 □	0.85±0.2	0.12±20%, 10%	20	25	220	0.30	250
CIL 21N R15 □	0.85±0.2	0.15±20%, 10%	20	25	200	0.40	250
CIL 21N R18 □	0.85±0.2	0.18±20%, 10%	20	25	185	0.40	250
CIL 21N R22 □	0.85±0.2	0.22±20%, 10%	20	25	170	0.50	250
CIL 21N R27 □	0.85±0.2	0.27±20%, 10%	20	25	150	0.50	250
CIL 21N R33 □	0.85±0.2	0.33±20%, 10%	20	25	145	0.55	250
CIL 21N R39 □	0.85±0.2	0.39±20%, 10%	25	25	135	0.65	200
CIL 21N R47 □	1.25±0.2	0.47±20%, 10%	25	25	125	0.65	200
CIL 21N R56 □	1.25±0.2	0.56±20%, 10%	25	25	115	0.75	150
CIL 21N R68 □	1.25±0.2	0.68±20%, 10%	25	25	105	0.80	150
CIL 21N R82 □	1.25±0.2	0.82±20%, 10%	25	25	100	1.00	150
CIL 21J 1R0 □	0.85±0.2	1.0±20%, 10%	45	10	75	0.40	50
CIL 21J 1R2 □	0.85±0.2	1.2±20%, 10%	45	10	65	0.50	50
CIL 21J 1R5 □	0.85±0.2	1.5±20%, 10%	45	10	60	0.50	50
CIL 21J 1R8 □	0.85±0.2	1.8±20%, 10%	45	10	55	0.60	50
CIL 21J 2R2 □	0.85±0.2	2.2±20%, 10%	45	10	50	0.65	30
CIL 21J 2R7 □	1.25±0.2	2.7±20%, 10%	45	10	45	0.75	30
CIL 21J 3R3 □	1.25±0.2	3.3±20%, 10%	45	10	41	0.80	30
CIL 21J 3R9 □	1.25±0.2	3.9±20%, 10%	45	10	38	0.90	30
CIL 21J 4R7 □	1.25±0.2	4.7±20%, 10%	45	10	35	1.00	30
CIL 21Y 5R6 □	1.25±0.2	5.6±20%, 10%	50	4	32	0.90	15
CIL 21Y 6R8 □	1.25±0.2	6.8±20%, 10%	50	4	29	1.00	15
CIL 21Y 8R2 □	1.25±0.2	8.2±20%, 10%	50	4	26	1.10	15
CIL 21Y 100 □	1.25±0.2	10.0±20%, 10%	50	2	24	1.15	15
CIL 21Y 120 □	1.25±0.2	12.0±20%, 10%	50	2	22	1.25	15
CIL 21S 150 □	1.25±0.2	15.0±20%, 10%	30	1	19	0.80	5
CIL 21S 180 □	1.25±0.2	18.0±20%, 10%	30	1	18	0.90	5
CIL 21S 220 □	1.25±0.2	22.0±20%, 10%	30	1	16	1.10	5
CIL 21S 270 □	1.25±0.2	27.0±20%, 10%	30	1	14	1.15	5
CIL 21S 330 □	1.25±0.2	33.0±20%, 10%	30	0.4	13	1.25	5

□: Tolerance (K: ±10%, M: ±20%)
* Test equipment: Agilent 4291B+16193A

CIL 3216(1206) Type

Part No.	Thickness (mm)	Inductance (μ H)	Q Min.	L, Q test frequency (MHZ)	SRF (MHZ) Min.	DC resistance (Ω) Max.	Rated current (mA) Max.
CIL 31N 47N□	0.6±0.2	0.047±20%, 10%	20	50	320	0.15	300
CIL 31N 68N□	0.6±0.2	0.068±20%, 10%	20	50	280	0.25	300
CIL 31N R10□	0.6±0.2	0.10±20%, 10%	20	25	235	0.25	250
CIL 31N R12□	0.6±0.2	0.12±20%, 10%	20	25	220	0.30	250
CIL 31N R15□	0.6±0.2	0.15±20%, 10%	20	25	200	0.30	250
CIL 31N R18□	0.6±0.2	0.18±20%, 10%	20	25	185	0.40	250
CIL 31N R22□	0.6±0.2	0.22±20%, 10%	20	25	170	0.40	250
CIL 31N R27□	0.6±0.2	0.27±20%, 10%	20	25	150	0.50	250
CIL 31N R33□	0.6±0.2	0.33±20%, 10%	20	25	145	0.60	250
CIL 31N R39□	1.1±0.2	0.39±20%, 10%	25	25	135	0.50	200
CIL 31N R47□	1.1±0.2	0.47±20%, 10%	25	25	125	0.60	200
CIL 31N R56□	1.1±0.2	0.56±20%, 10%	25	25	115	0.70	150
CIL 31N R68□	1.1±0.2	0.68±20%, 10%	25	25	105	0.80	150
CIL 31N R82□	1.1±0.2	0.82±20%, 10%	25	25	100	0.90	150
CIL 31J 1R0□	0.6±0.2	1.0±20%, 10%	45	10	75	0.40	100
CIL 31J 1R2□	0.6±0.2	1.2±20%, 10%	45	10	65	0.50	100
CIL 31J 1R5□	1.1±0.2	1.5±20%, 10%	45	10	60	0.50	50
CIL 31J 1R8□	1.1±0.2	1.8±20%, 10%	45	10	55	0.50	50
CIL 31J 2R2□	1.1±0.2	2.2±20%, 10%	45	10	50	0.60	50
CIL 31J 2R7□	1.1±0.2	2.7±20%, 10%	45	10	45	0.60	50
CIL 31J 3R3□	1.1±0.2	3.3±20%, 10%	45	10	41	0.70	50
CIL 31J 3R9□	1.1±0.2	3.9±20%, 10%	45	10	38	0.80	50
CIL 31J 4R7□	1.1±0.2	4.7±20%, 10%	45	10	35	0.90	50
CIL 31Y 5R6□	1.1±0.2	5.6±20%, 10%	50	4	32	0.70	25
CIL 31Y 6R8□	1.1±0.2	6.8±20%, 10%	50	4	29	0.80	25
CIL 31Y 8R2□	1.1±0.2	8.2±20%, 10%	50	4	26	0.90	25
CIL 31Y 100□	1.1±0.2	10.0±20%, 10%	50	2	24	1.00	25
CIL 31Y 120□	1.1±0.2	12.0±20%, 10%	50	2	22	1.05	15
CIL 31S 150□	1.1±0.2	15.0±20%, 10%	35	1	19	0.70	5
CIL 31S 180□	1.1±0.2	18.0±20%, 10%	35	1	18	0.70	5
CIL 31S 220□	1.1±0.2	22.0±20%, 10%	35	1	16	0.90	5
CIL 31S 270□	1.1±0.2	27.0±20%, 10%	35	1	14	0.90	5
CIL 31S 330□	1.1±0.2	33.0±20%, 10%	35	0.4	13	1.05	5

□: Tolerance (K: ±10%, M: ±20%)
 ※ Test equipment: Agilent 4291B+16193A

1608 Type

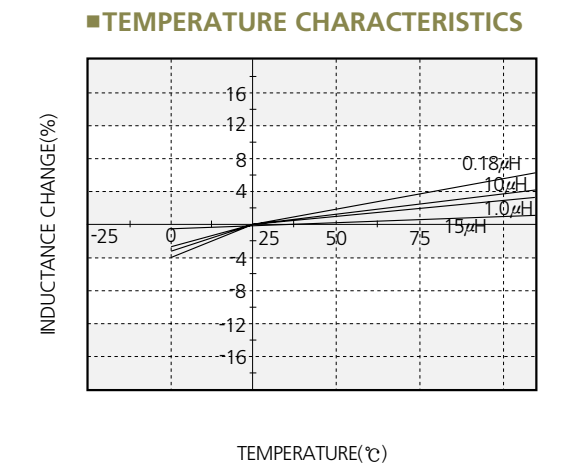
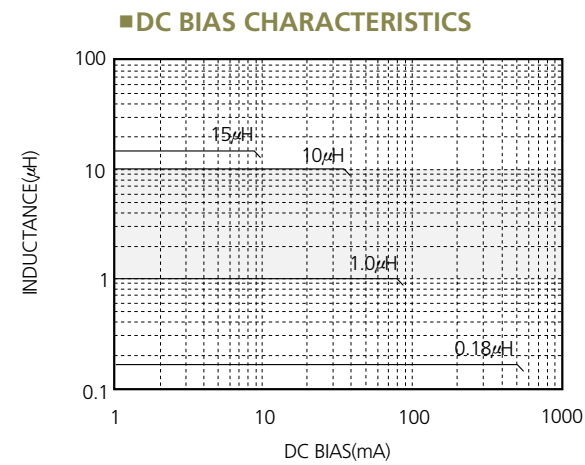
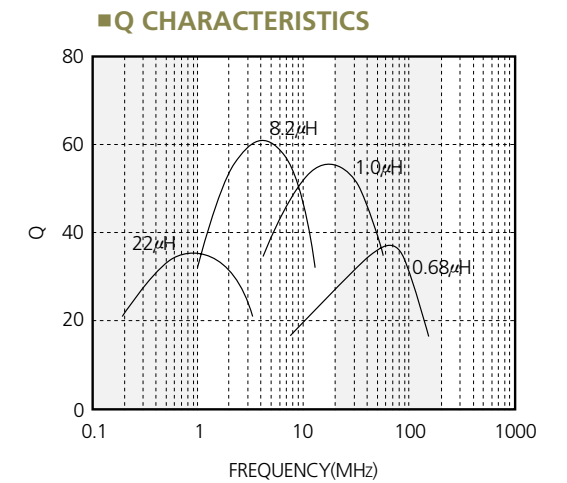
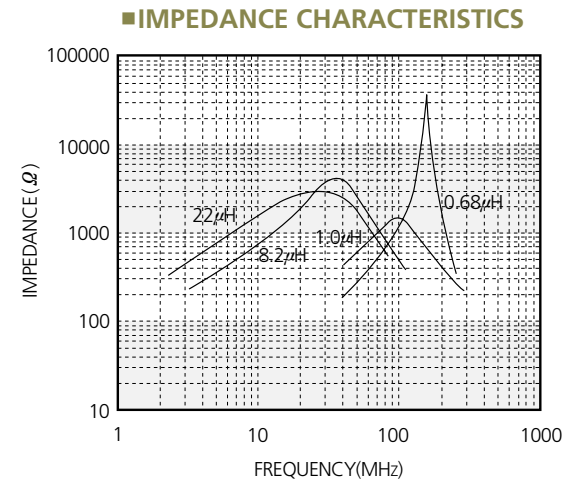

2012 Type

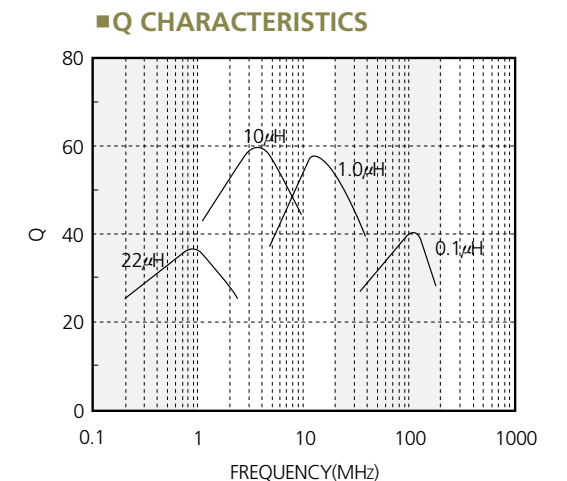
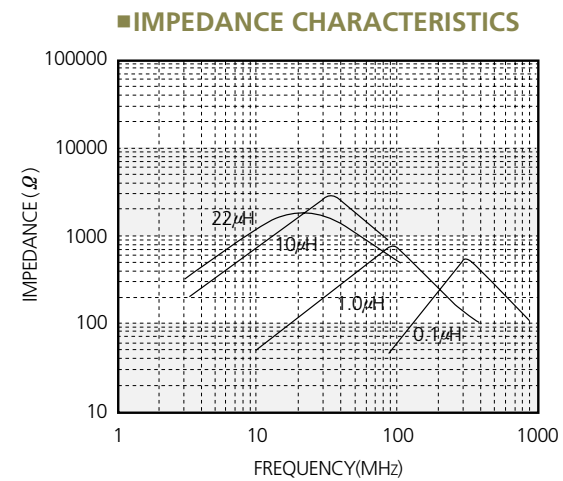

DC BIAS CHARACTERISTICS

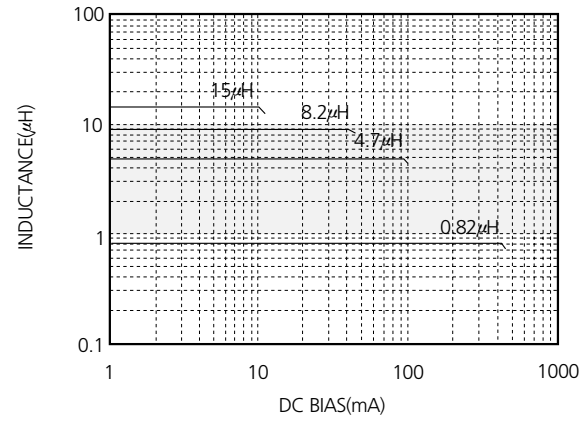

TEMPERATURE CHARACTERISTICS

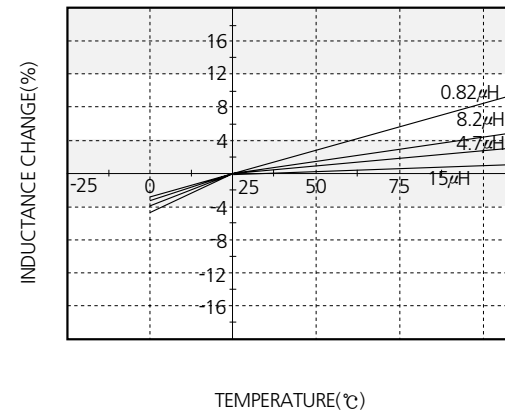

3216 Type

IMPEDANCE CHARACTERISTICS

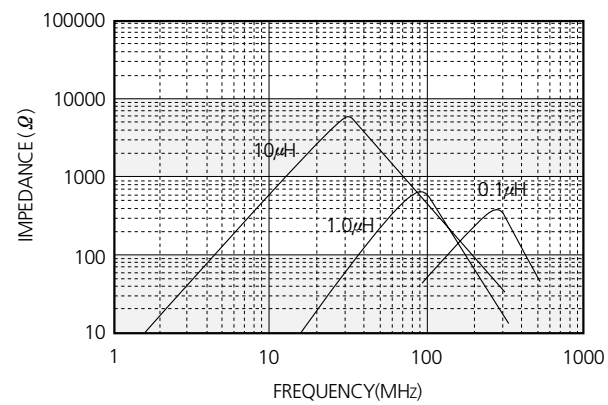

Q CHARACTERISTICS

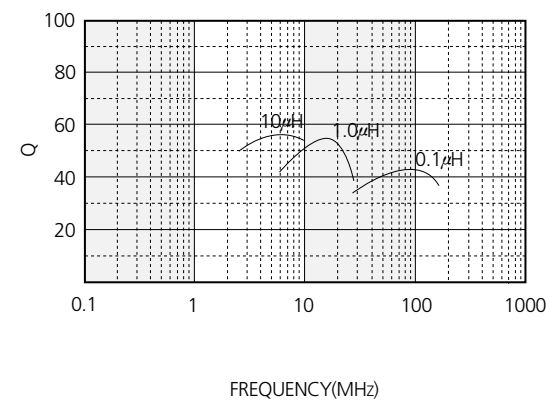

DC BIAS CHARACTERISTICS

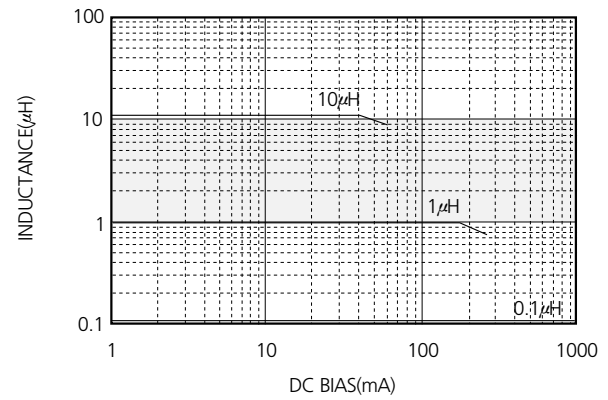

TEMPERATURE CHARACTERISTICS

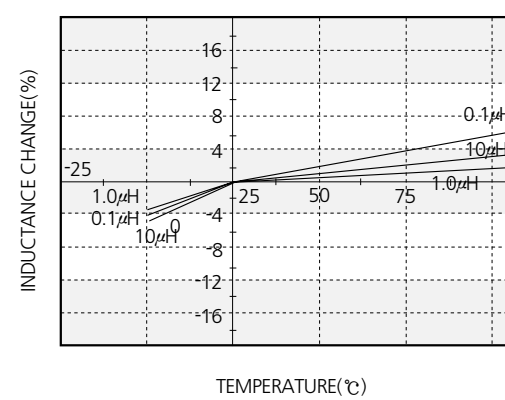

Feature

- Lowest value of specific resistivity, good property of Q and high SRF.
- Possible to use at range above 100MHz
- Monolithic structure for high reliability.

Application

- Mobile communication systems, noise suppression at high frequency and Impedance matching.

CIH Series has dielectric material and 100% Ag as an internal conductor Therefore, it has high Q and IZl at high frequency. It is possible to use for high frequency over 100MHz.

Dimensions

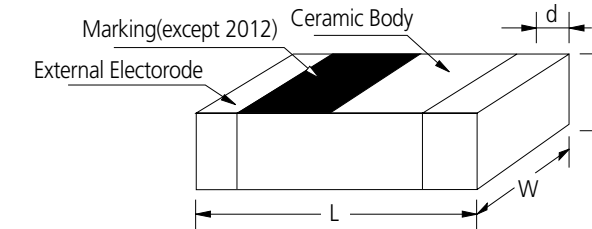

Unit : mm

SIZE CODE	L	W	t	d
03	0.6±0.03	0.3±0.03	0.3±0.03	0.15±0.05
05	1.0±0.05	0.5±0.05	0.5±0.05	0.25±0.1
10	1.6±0.15	0.8±0.15	0.8±0.15	0.3±0.2
21	2.0±0.2	1.25±0.2	0.85±0.2 1.00+0.2/-0.3	0.5+0.2/-0.3

Part Numbering

CI H 03 T 12N J N C
(1) (2) (3) (4) (5) (6) (7) (8)

- (1) Chip Inductor
- (2) H: High frequency type
- (3) Dimension
- (4) Material code (T: Dielectric material)
- (5) Inductance (4N7: 4.7nH, 10N: 10nH, R10: 100nH)
- (6) Tolerance (S: ±0.3nH, J: ±5%, K: ±10%, C: ±0.2nH)
- (7) Thickness option (N: Standard, A: Thinner than standard, B: Thicker than standard)
- (8) Packaging (C: paper tape, E: embossed tape)

CIH 0603(0201) Type

Part No.	Inductance (nH)	Q (Min.) 100 MHz	Q (typical) Frequency (MHz)					SRF-Resonant Frequency (MHz) min	DC resistance (Ω) max	Rated current (mA) Max.
			100	300	500	800	1000			
			CIH 03T 1N0 □	1.0±0.2nH, 0.3nH	4	6	12	17	20	
CIH 03T 1N2 □	1.2±0.2nH, 0.3nH	4	6	12	16	20	24	10000	0.14	250
CIH 03T 1N5 □	1.5±0.2nH, 0.3nH	4	6	12	15	20	23	10000	0.18	230
CIH 03T 1N8 □	1.8±0.2nH, 0.3nH	4	6	12	15	20	23	10000	0.19	200
CIH 03T 2N2 □	2.2±0.2nH, 0.3nH	4	6	12	15	20	22	8800	0.22	200
CIH 03T 2N7 □	2.7±0.2nH, 0.3nH	5	7	12	15	20	22	7700	0.25	200
CIH 03T 3N3 □	3.3±0.2nH, 0.3nH	5	7	12	15	20	22	6700	0.30	200
CIH 03T 3N9 □	3.9±0.2nH, 0.3nH	5	7	12	15	20	22	6000	0.30	200
CIH 03T 4N7 □	4.7±0.2nH, 0.3nH	5	7	12	15	19	21	5300	0.40	200
CIH 03T 5N6 □	5.6±0.2nH, 0.3nH	5	7	12	15	19	21	4600	0.40	200
CIH 03T 6N8 □	6.8±5%	5.5	7	11	14	18	20	4100	0.48	150
CIH 03T 8N2 □	8.2±5%	5	7	11	14	18	19	3400	0.55	150
CIH 03T 10N □	10.0±5%	5	7	11	14	17	18	3300	0.63	150
CIH 03T 12N □	12.0±5%	6	7	11	14	17	18	3000	0.70	150
CIH 03T 15N □	15.0±5%	6	7	11	13	16	17	2700	0.80	100
CIH 03T 18N □	18.0±5%	6	7	11	13	18	19	2100	0.90	100
CIH 03T 22N □	22.0±5%	5	7	11	13	15	16	1800	1.2	100
CIH 03T 27N □	27.0±5%	4	6	10	12	14	15	1800	1.8	50
CIH 03T 33N □	33.0±5%	4	6	10	12	14	14	1700	2.1	50
CIH 03T 39N □	39.0±5%	4	6	10	12	13	12	1500	2.4	50
CIH 03T 47N □	47.0±5%	4	6	10	11	12	11	1300	2.8	50
CIH 03T 56N □	56.0±5%	4	6	10	11	11	10	1100	3.0	50

□: Tolerance (C: ±0.2nH, S: ±0.3nH, J: ±5%)
* Test equipment: Agilent E4991A+16196C

CIH 1005(0402) Type

Part No.	Inductance (nH) @100MHz	Q (typical.)			SRF (MHz) Min.	DC resistance (Ω) Max.	Rated current (mA) Max.
		100MHz	800MHz	1800MHz			
CIH 05T 1N0 S	1.0±0.3nH	8	20	30	10000	0.12	300
CIH 05T 1N2 S	1.2±0.3nH	8	20	28	10000	0.12	300
CIH 05T 1N5 S	1.5±0.3nH	8	22	35	6000	0.13	300
CIH 05T 1N8 S	1.8±0.3nH	8	22	35	6000	0.14	300
CIH 05T 2N2 S	2.2±0.3nH	8	22	35	6000	0.16	300
CIH 05T 2N7 S	2.7±0.3nH	8	22	35	6000	0.17	300
CIH 05T 3N3 □	3.3±10%, 0.3nH	8	22	35	6000	0.19	300
CIH 05T 3N9 □	3.9±10%, 0.3nH	8	22	32	4000	0.22	300
CIH 05T 4N7 □	4.7±10%, 0.3nH	8	22	32	4000	0.24	300
CIH 05T 5N6 □	5.6±10%, 0.3nH	8	22	29	4000	0.27	300
CIH 05T 6N8 □	6.8±5%, 10%	8	21	29	3900	0.32	250
CIH 05T 8N2 □	8.2±5%, 10%	8	21	29	3600	0.37	250
CIH 05T 10N □	10.0±5%, 10%	8	21	28	3200	0.42	250
CIH 05T 12N □	12.0±5%, 10%	8	20	27	2700	0.50	250
CIH 05T 15N □	15.0±5%, 10%	8	20	21	2300	0.55	250
CIH 05T 18N □	18.0±5%, 10%	8	20	15	2100	0.65	200
CIH 05T 22N □	22.0±5%, 10%	8	20	13	1900	0.80	200
CIH 05T 27N □	27.0±5%, 10%	8	17	-	1600	0.90	200
CIH 05T 33N □	33.0±5%, 10%	8	17	-	1300	1.00	200
CIH 05T 39N □	39.0±5%, 10%	8	16	-	1200	1.20	150
CIH 05T 47N □	47.0±5%, 10%	8	15	-	1000	1.30	150
CIH 05T 56N □	56.0±5%, 10%	8	-	-	750	1.40	150
CIH 05T 68N □	68.0±5%, 10%	8	-	-	750	1.40	150
CIH 05T 82N □	82.0±5%, 10%	8	-	-	600	1.60	100
CIH 05T R10 □	100.0±5%, 10%	8	-	-	600	1.60	100

□: Tolerance (S: ±0.3nH, J: ±5%, K: ±10%)
* Test equipment: Agilent 4291B+16192A

CIH 1608(0603) Type

Part No.	Inductance (nH) @100MHz	Q (typical)		SRF (MHz) Min.	DC resistance (Ω) Max.	Rated current (mA) Max.
		100MHz	800MHz			
CIH 10T 1N0 S	1.0±0.3nH	8	20	10000	0.05	300
CIH 10T 1N2 S	1.2±0.3nH	8	20	10000	0.05	300
CIH 10T 1N5 S	1.5±0.3nH	8	20	6000	0.10	300
CIH 10T 1N8 S	1.8±0.3nH	8	20	6000	0.10	300
CIH 10T 2N2 S	2.2±0.3nH	8	20	6000	0.10	300
CIH 10T 2N7 S	2.7±0.3nH	10	25	6000	0.10	300
CIH 10T 3N3□	3.3±0.3nH, 10%	10	25	6000	0.12	300
CIH 10T 3N9□	3.9±0.3nH, 10%	10	27	6000	0.14	300
CIH 10T 4N7□	4.7±0.3nH, 10%	10	27	4000	0.16	300
CIH 10T 5N6□	5.6±0.3nH, 10%	10	27	4000	0.18	300
CIH 10T 6N8□	6.8±10%, 5%	10	27	4000	0.22	300
CIH 10T 8N2□	8.2±10%, 5%	10	26	3500	0.24	300
CIH 10T 10N□	10.0±10%, 5%	12	26	3400	0.26	300
CIH 10T 12N□	12.0±10%, 5%	12	24	2600	0.28	300
CIH 10T 15N□	15.0±10%, 5%	12	24	2300	0.32	300
CIH 10T 18N□	18.0±10%, 5%	12	24	2000	0.35	300
CIH 10T 22N□	22.0±10%, 5%	12	25	1600	0.40	300
CIH 10T 27N□	27.0±10%, 5%	12	25	1400	0.45	300
CIH 10T 33N□	33.0±10%, 5%	12	24	1200	0.55	300
CIH 10T 39N□	39.0±10%, 5%	12	20	1100	0.60	300
CIH 10T 47N□	47.0±10%, 5%	12	20	900	0.77	300
CIH 10T 56N□	56.0±10%, 5%	12	20	900	0.75	300
CIH 10T 68N□	68.0±10%, 5%	12	⁽¹⁾ 20	700	0.85	300
CIH 10T 82N□	82.0±10%, 5%	12	⁽¹⁾ 20	600	0.95	300
CIH 10T R10□	100.0±10%, 5%	12	⁽¹⁾ 20	600	1.00	300
CIH 10T R12□	120.0±10%, 5%	⁽²⁾ 8	-	500	1.20	300
CIH 10T R15□	150.0±10%, 5%	⁽²⁾ 8	-	500	1.20	300
CIH 10T R18□	180.0±10%, 5%	⁽²⁾ 8	-	400	1.30	300
CIH 10T R22□	220.0±10%, 5%	⁽²⁾ 8	-	400	1.50	300
CIH 10T R27□	270.0±10%, 5%	⁽²⁾ 8	-	400	1.50	300

□: Tolerance (S: ±0.3nH, J: ±5%, K: ±10%)
 * Test equipment: Agilent 4291B+16192A

⁽¹⁾ 500MHz, ⁽²⁾ 50MHz,

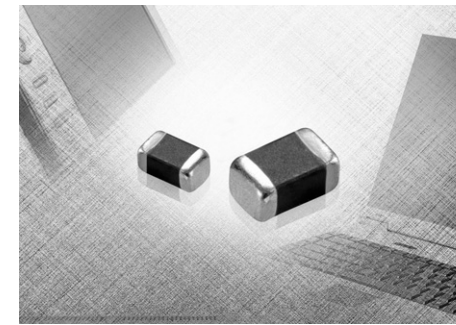

General Features

- Low profile (1.0mm max height)
- Magnetically shielded and Low DC resistance
- Lead free termination and internal electrode
- Monolithic structure for high reliability

Application

- Mobile phones, DSC, DVC, PDA etc. for DC-DC Converter

Dimensions

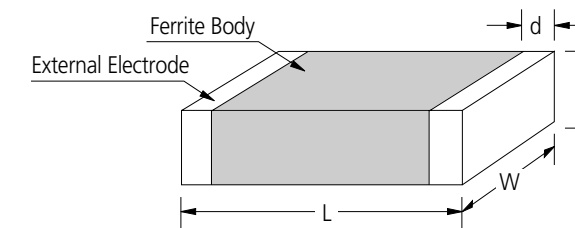

SIZE CODE	Dimension (mm)			
	L	W	t	d
21	2.0±0.2	1.25±0.2	1.0 max / 0.5max	0.2~0.7
22	2.5±0.2	2.0±0.2	1.0 max	0.3~0.8

Part Numbering

CI G 22 L 4R7 M N E
 (1) (2) (3) (4) (5) (6) (7) (8)

- (1) Chip inductor
- (2) Power inductor
- (3) Dimensions
- (4) Product Series (W: Normal Type, L: Low Rdc Type, F: Low Profile Type)
- (5) Inductance (2R2: 2.2uH, 4R7: 4.7uH)
- (6) Tolerance (M: ±20%)
- (7) Thickness Option (N: Standard)
- (8) Package Style (C: Paper tape / 7" reel, E: Embossed tape / 7" reel)

CIG 2012(0805) Type - Low Profile

Part No.	Inductance (μ H) @1MHz	DC Resistance (Ω)	Rated Current. Idc (A) $\Delta T = 40^\circ\text{C}$
CIG21F2R2MNC	2.2 \pm 20 %	0.34 \pm 25 %	0.60

CIG 2012(0805) Type

Part No.	Inductance (μ H) @1MHz	DC Resistance (Ω)	Rated Current. Idc (A) $\Delta T = 40^\circ\text{C}$
CIG21W1R0MNE	1.0 \pm 20 %	0.13 \pm 20 %	1.05
CIG21W1R5MNE	1.5 \pm 20 %	0.15 \pm 20 %	0.96
CIG21W2R2MNE	2.2 \pm 20 %	0.20 \pm 20 %	0.81
CIG21W3R3MNE	3.3 \pm 20 %	0.25 \pm 20 %	0.73
CIG21W4R7MNE	4.7 \pm 20 %	0.30 \pm 20 %	0.65

CIG 2520(1008) Type-Low RDC

Part No.	Inductance (μ H) @1MHz	DC Resistance (Ω)	Rated Current. Idc (A) $\Delta T = 40^\circ\text{C}$
CIG22L1R0MNE	1.0 \pm 20 %	0.06 \pm 30 %	1.5
CIG22L1R2MNE	1.2 \pm 20 %	0.065 \pm 30 %	1.5
CIG22L1R5MNE	1.5 \pm 20 %	0.07 \pm 30 %	1.5
CIG22L2R2MNE	2.2 \pm 20 %	0.08 \pm 30 %	1.3
CIG22L3R3MNE	3.3 \pm 20 %	0.10 \pm 30 %	1.2
CIG22L4R7MNE	4.7 \pm 20 %	0.11 \pm 30 %	1.1
CIG22L6R8MNE	6.8 \pm 20 %	0.20 \pm 30 %	0.8
CIG22L100MNE	10.0 \pm 20 %	0.32 \pm 30 %	0.6

* Test equipment : Agilent 4291B+16193A

CIG 2012(0805) Type - Low Profile

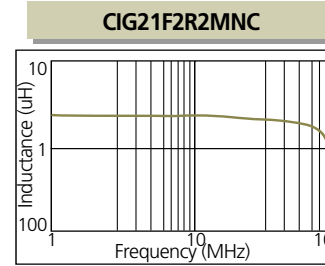

CIG 2012(0805) Type

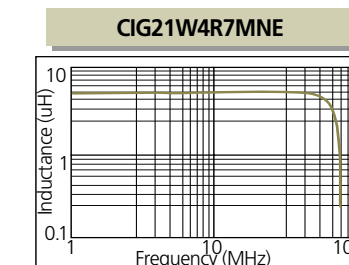
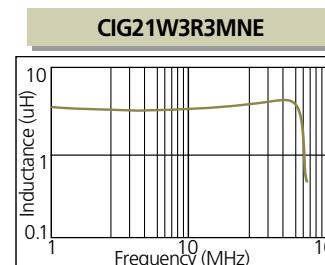
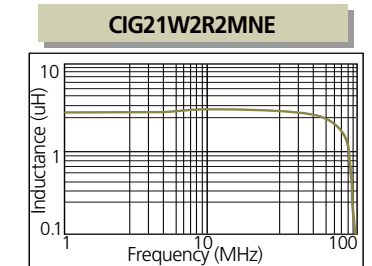
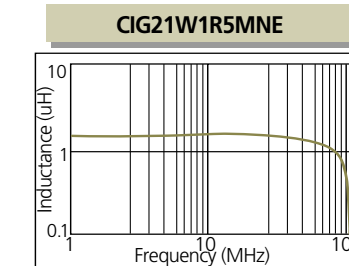
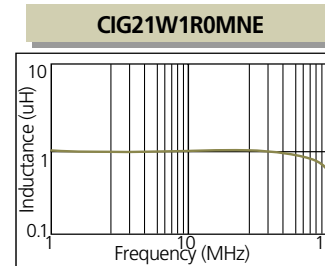

CIG 2520(1008) Type-Low RDC

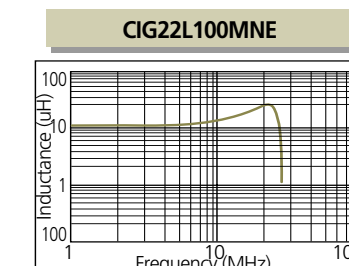
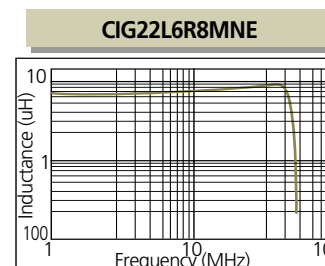
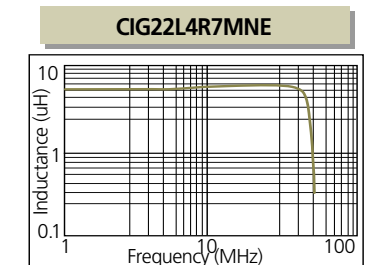
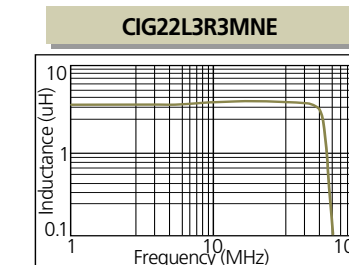
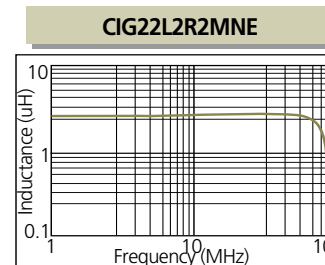
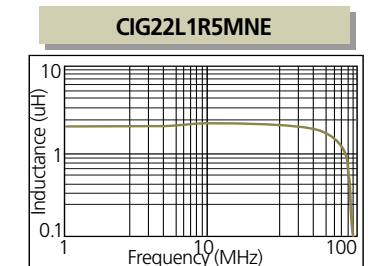
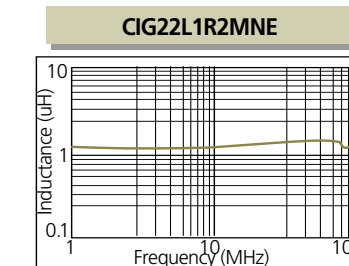
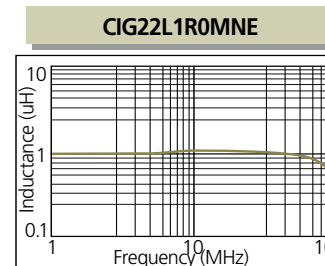

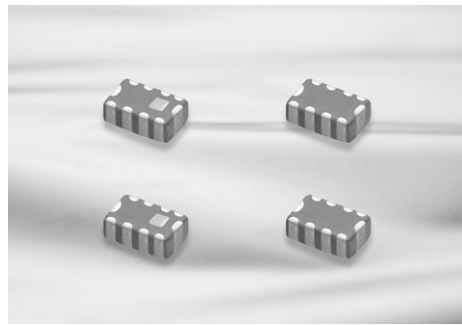

Feature

- EMI LC Filter's Property
 - Steep Cut off frequency Characteristics
 - Good Attenuation in GSM, CDMA, PCS Frequency Range (570 MHz ~ 1900 MHz)
 - High Attenuation Characteristics (-20 dB) on broad band (450 MHz ~ 3000 MHz)
 - No deterioration of signal level in Low Frequency range
 - No Voltage Drop phenomena (Low DC Resistance)
- ESD LC Filter's Property
 - High α Value
 - Assurance of 8kV ESD Protection (contact discharge)

Application

- Suitable for high speed data lines, I/O
- Noise suppression of Digital Equipment
- Applicable to LCD line and Camera circuit of HHP

EMI LC filter reduces EMI emissions in LCD, camera lines and protect against ESD.
ESD LC Filter also applies to LCD and camera data lines and provides high-level of ESD protection as well as EMI suppression.

Dimensions

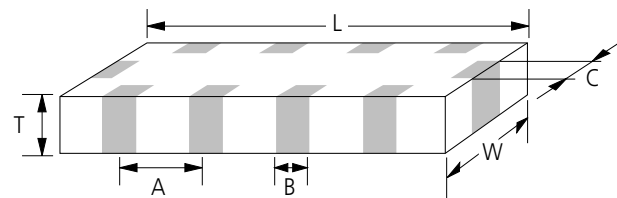

Unit : mm

SIZE CODE	L	W	T	A	B	C
10	1.60±0.1	0.8±0.1	0.55±0.1	0.40±0.1	0.20±0.1	0.20±0.1
21	2.00±0.2	1.25±0.2	0.75±0.2 0.55±0.1	0.50±0.1	0.25±0.1	0.40+0.2/-0.1

Part Numbering

EMIL 21 C 180 S A N E
(1) (2) (3) (4) (5) (6) (7) (8)

- Chip EMI Filter LC Array
L : LC Array Type
R : LCR Array Type
X : ESD LC Array Type
- Dimension
- Capacitance Temperature Characteristics [C : ±30(ppm/°C) at -40°C ~ +85°C]
- Nominal Capacitance [180 : 18(pF)]
- Capacitance Tolerance (S : -20% ~ +50%, M : ±20%)
- Rated Voltage [B : 50(V), A : 25(V), O : 16(V), P : 10(V)]
- Thickness Option
(N:Standard, A:Thinner than standard, B: Thicker than standard)
- Packaging
(C:Paper Type, E: Embossed Type)

Type of Filters & Equivalent Circuits

Type	EMI LC Array		EMI LCR Array	ESD LC Array
	π Type Filter	L Type Filter	L Type Filter	π Type Filter
Equivalent Circuit				
Line up	EMIL21C070SANE EMIL21C150SANE EMIL21C180SANE EMIL21C270SAAE	EMIL21C220MANE EMIL10C220MPAC	EMIR21C22050NE	EMIX21A280FNPC EMIX21A390FNPC

EMI LC Array Type

Part Number	Nominal Capacitance (pF) (at 1MHz)	Cut-off Frequency (MHz)	Rated Voltage (V)DC	Rated Current (mA)	Insulation Resistance (M Ω)	Typical Attenuation Range (MHz)
EMIL21C070SANE	7	450	25	100	Min. 1000	750~900(25dB)
EMIL21C150SANE	15	350	25	100	Min. 1000	750~1200(30dB)
EMIL21C180SANE	18	350	25	100	Min. 1000	760~1360(35dB)
EMIL21C220MANE	22	300	25	100	Min. 1000	700~1500(20dB)
EMIL21C270SAAE	27	400	25	100	Min. 1000	700~1500(30dB)
EMIL10C220MPAC	22	360	10	35	Min. 1000	820~1580(30dB)

EMI LCR Array Type

Part Number	Resistance (Ω)	Capacitance (pF)	Rated Voltage (V)DC	Rated Current (mA)	Typical Attenuation Range (MHz)
EMIR21C22050NE	50	22	10	25	670~2120(30dB)

ESD LC Array Type

Part Number	Capacitance (pF)	Cut-off Frequency (MHz)	Working Frequency (V)	Varistor Voltage (V)	Clamping Voltage (V) (Typ)	Typical Attenuation Range (MHz)
EMIX21A280FNPC	28	270	18	25	50	1300~2220(30dB)
EMIX21A390FNPC	39	220	18	28	60	650~1580(30dB)

EMI LC Array Type

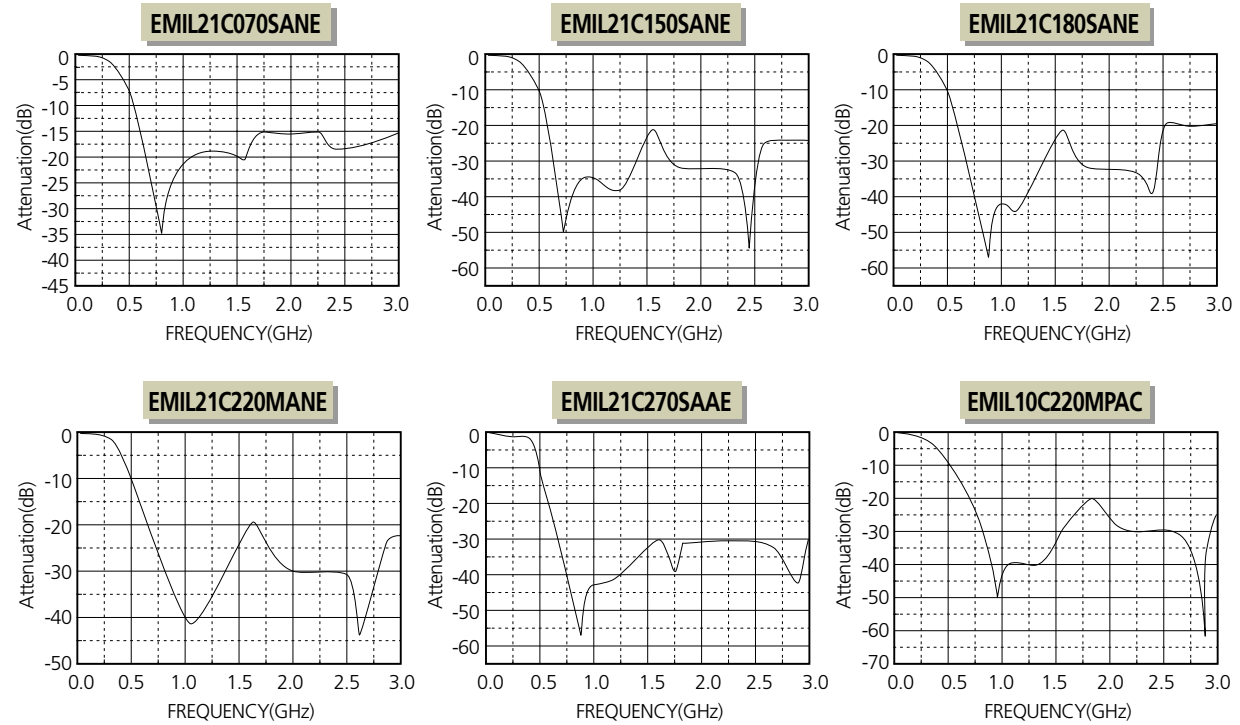

EMI LCR Array Type

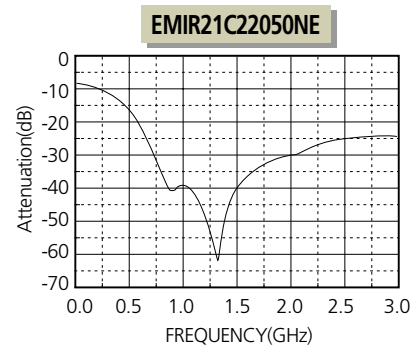

ESD LC Array Type

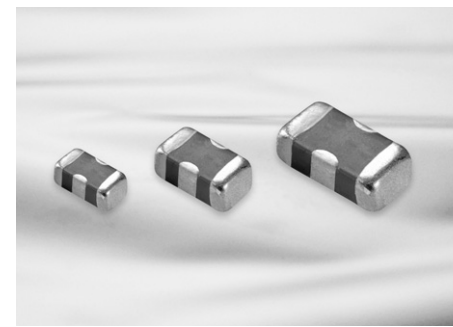
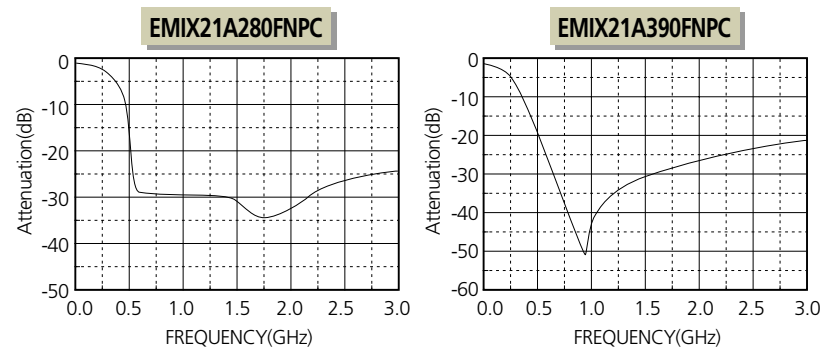

Feature

- Lower ESL Characteristics
- High Performance at High Frequency Range
- Small size enables high density mounting
- Effective noise suppression filter

Application

- High frequency EMI prevention applicable to digital equipment such as TV, VCR, LCD monitors and PDP TVs.
- Computer equipment such as personal computers and peripherals.

More excellent by-pass filter than MLCC.
EMIC Series is capacitor type of three terminals and low residual inductance value.

Dimensions

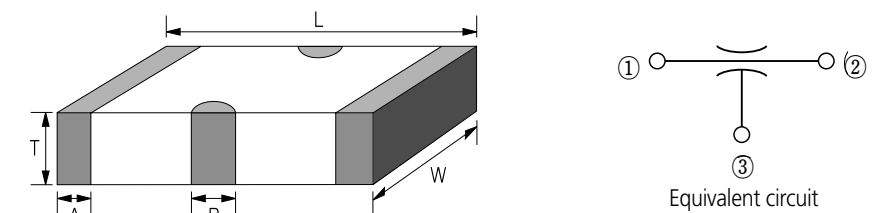

Unit : mm

SIZE CODE	L	W	T	A	B
10	1.6±0.15	0.8±0.1	0.6±0.1	0.25±0.15	0.4±0.1
21	2.0±0.2	1.25±0.2	0.8±0.2	0.3±0.2	0.6±0.2
31	3.2±0.2	1.6±0.2	1.1max	0.4±0.3	1.0±0.3

Part Numbering

EMI C 10 B 473 S A N C
(1) (2) (3) (4) (5) (6) (7) (8) (9)

- Chip EMI Filter of SAMSUNG
- Series
C : For signal line
P : For Power line
- Dimensions
- Capacitance temperature characteristics
C : 0±30ppm/°C
A : ±15% (-55~85°C)
B : ±15% (-55~125°C)
F : -82~+22% (-30~+85°C)
- Nominal capacitance (101: 100pF, 102: 1000pF, 104: 100000pF)
- Capacitance tolerance (M: ±20%, S: +50%, -20%)
- Rated voltage (P: 10V, O: 16V, A: 25V, B: 50V)
- Thickness option (N: Standard, A: Thinner than standard, B: Thicker than standard)
- Packaging (C: Paper 7" Reel, D: Paper 13" Reel)

EMIP 1608(0603) Type

Part No.	Capacitance (pF)	Tolerance	Rated Voltage (V) Max.	Insulation Resistance (M Ω)	DC Resistance (Ω) Max.	Rated Current (mA) Max
EMIP10B104MONC	100000	+20~-20%	16	1000 min	0.1	2000

EMIC 2012(0805) Type

Part No.	Capacitance (pF)	Tolerance	Rated Voltage (V) Max.	Insulation Resistance (M Ω)	DC Resistance (Ω) Max.	Rated Current (mA) Max
EMIC21B471SBNC	470	+50~-20%	50	10000 min	0.3	300
EMIC21B223SBNC	22000	+50~-20%	50	10000 min	0.08	1000
EMIC21F104SANC	100000	+50~-20%	25	1000 min	0.1	1000

EMIP 2012(0805) Type

Part No.	Capacitance (pF)	Tolerance	Rated Voltage (V) Max.	Insulation Resistance (M Ω)	DC Resistance (Ω) Max.	Rated Current (mA) Max
EMIP21F104SANC	100000	+50~-20%	25	1000 min	0.05	2000
EMIP21F105ZOB	1000000	+80~-20%	16	500 min	0.04	3000

EMIC 3216(1206) Type

Part No.	Capacitance (pF)	Tolerance	Rated Voltage (V) Max.	Insulation Resistance (M Ω)	DC Resistance (Ω) Max.	Rated Current (mA) Max
EMIC31B222MANC	2200	+20~-20%	25	1000 min	0.3	300
EMIC31B104SANC	100000	+50~-20%	25	1000 min	0.1	1000

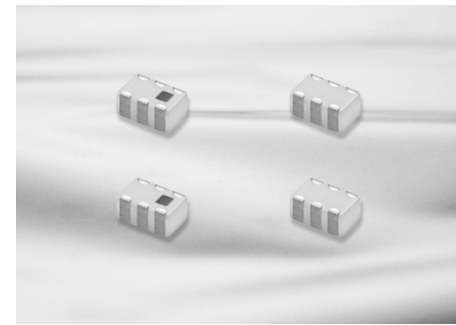

Feature

- Small and thin size
- Low Insertion Loss
- Lead free

Application

- Applying to mobile phones and wireless LAN Combo.
- AMPS/GPS, AMPS/PCS, CDMAWCDMA, CDMA5-DMB, PCS/S-DMB, T-DMB/CDMA,
- T-DMB/K-PCS, CDMAW-LAN, CDMAK-PCS, iDEN/GPS

Diplexer is used for separating specific frequency in mobile phones and wireless LAN 11a/b/g. Two kinds of pin assignment demanded on customers are lined up so that designing circuit regardless output direction is available.

Dimensions

■ F Type

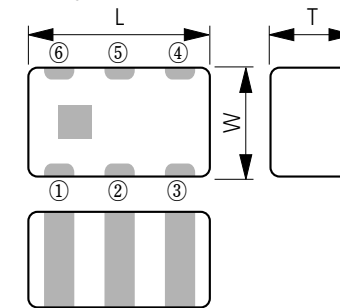

■ H Type

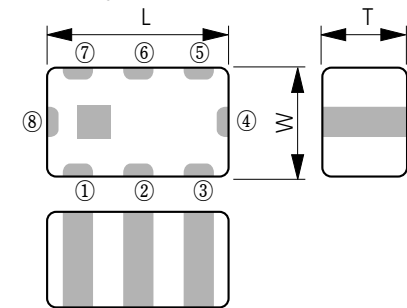

Dimension(mm)		Terminal	
L	2.00±0.15	Common	②
W	1.25±0.15	Low Band	⑥
T	0.95±0.15	High Band	④
		GND	① ③ ⑤

Dimension(mm)		Terminal	
L	2.00±0.15	Common	②
W	1.25±0.15	Low Band	⑧
T	0.95±0.15	High Band	④
		GND	① ③ ⑤ ⑥ ⑦

※ Pin assignment can be changeable

Part Numbering

DX 21 T F 3L 01
 (1) (2) (3) (4) (5) (6)

- (1) Diplexer
- (2) Dimension
- (3) Material code
- (4) Terminal number (F: 6, H: 8)
- (5) Low band: Band 3
High band: L Band
- (6) Serial number, pin assignment

HHP Diplexer

Part No.	Application	Thickness (mm)	Center Frequency	Insertion Loss (dB) Max.	Attenuation(dB) Min.
DX21TFAG01	AMPS / GPS	0.95	859MHz/1575MHz	0.5 at 859MHz	15 at 1575MHz
				0.7 at 1575MHz	20 at 859MHz
DX21TFAG02	AMPS / GPS	0.95	859MHz/1575MHz	0.5 at 859MHz	15 at 1575MHz
				0.7 at 1575MHz	20 at 859MHz
DX21TFAP02	AMPS / PCS	0.95	859MHz/1920MHz	0.5 at 859MHz	20 at 1920MHz
				0.55 at 1920MHz	20 at 859MHz
DX21TFAP03	AMPS / PCS	0.95	859MHz/1920MHz	0.5 at 859MHz	20 at 1920MHz
				0.55 at 1920MHz	20 at 859MHz
DX21TFEP01	EGSM / PCS	0.95	942.5MHz/1960MHz	0.5 at 942.5MHz	20 at 1960MHz
				0.55 at 1960MHz	20 at 942.5MHz
DX21TFGD03	GSM / DCS	0.95	881.5MHz/1842.5MHz	0.5 at 881.5MHz	20 at 1842.5MHz
				0.55 at 1842.5MHz	20 at 881.5MHz
DX21TFKW01	K-CDMA / W-CDMA	0.95	859MHz/2045MHz	0.5 at 859MHz	15 at 2045MHz
				0.6 at 2045MHz	20 at 859MHz
DX21DFIG01	iDEN / GPS	1.05	873.5MHz/1575.42MHz	0.65 at 873.5MHz	16 at 1575.42MHz
					16 at 1631MHz
					13 at 1798MHz
				0.70 at 1575.42MHz	17 at 873.5MHz
DX21TFCD01	CDMA / S-DMB	0.95	859MHz/2630MHz	0.5 at 859MHz	20 at 2630MHz
				0.6 at 2630MHz	20 at 859MHz
DX21TFCD02	CDMA / S-DMB	0.95	859MHz/2630MHz	0.5 at 859MHz	17 at 2630MHz
				0.6 at 2630MHz	20 at 859MHz
DX21TFKD01	K-PCS / S-DMB	0.95	1810MHz/2642.5MHz	0.8 at 1810MHz	15 at 2642.5MHz
				1.0 at 2642.5MHz	15 at 1810MHz
DX21TFGD01	CDMA+GPS / S-DMB	0.95	859MHz+1575.42MHz/2645MHz	0.6 at 859MHz	15 at 2642.5MHz
				0.8 at 1575.42MHz	
				0.8 at 2642.5MHz	15 at 859MHz
					15 at 1575.42MHz
DX21TFDK01	T-DMB / K-PCS	0.95	207MHz/1810MHz	0.5 at 207MHz	15 at 1810MHz
				0.7 at 1810MHz	20 at 207MHz
DX21TFCL01	CDMA / W-LAN	0.95	859MHz/2450MHz	0.5 at 859MHz	20 at 2450MHz
				0.6 at 2450MHz	20 at 859MHz

HHP Diplexer

Part No.	Application	Thickness (mm)	Center Frequency	Insertion Loss (dB) Max.	Attenuation(dB) Min.
DX21TFKL01	K-PCS / W-LAN	0.95	1810MHz/2450MHz	0.8 at 1810MHz	15 at 2450MHz
				1.0 at 2450MHz	15 at 1810MHz
DX21TFCK02	CDMA / K-PCS	0.95	859MHz/1810MHz	0.5 at 859MHz	15 at 2345MHz
				0.7 at 1810MHz	20 at 859MHz
DX21TFKO01	K-PCS / WiBro	0.95	1810MHz/235MHz	0.8 at 1810MHz	15 at 2345MHz
				1.0 at 2345MHz	15 at 1810MHz
DX21TF3L01	Band III / L-Band	0.95	207MHz/1472MHz	0.5 at 207MHz	15 at 1472MHz
				0.7 at 1472MHz	20 at 207MHz
DX21TFM01	Cellular / WiMAX	1.00	1368MHz/2592.5MHz	1.0 at 1368MHz	15 at 2592.5MHz
				1.2 at 2592.5MHz	20 at 1368MHz

WLAN 11a/b/g Diplexer

Part No.	Type	Thickness (mm)	Pass Band (MHz)	Insertion Loss (dB) Max.	Return Loss (dB) Min.	Attenuation(dB) Min. (at MHz)
DX21THWC01	LPF+HPF	1.00	2400~2500	0.50	10	17 (4900~5850)
			4900~5850	0.75	10	21(2400~2500)

Characteristics

Characteristics

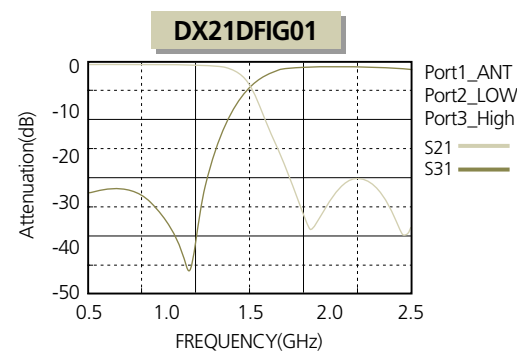
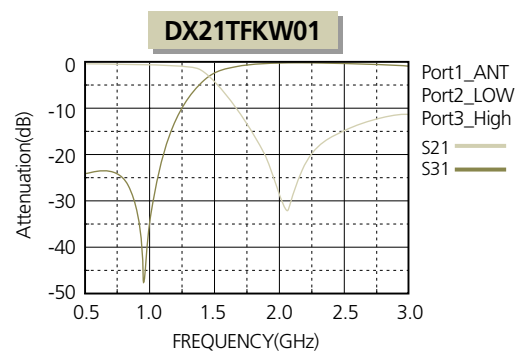
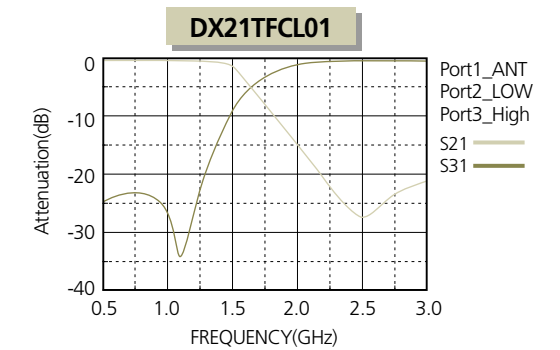
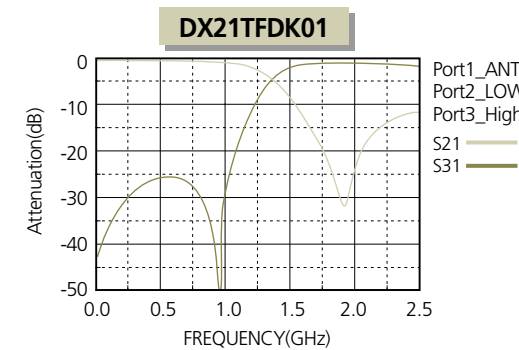
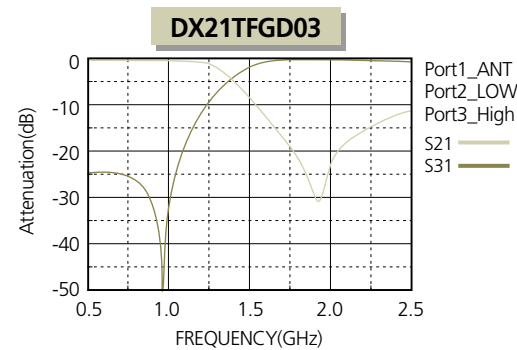
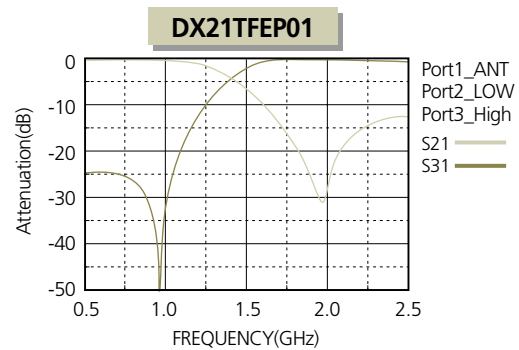
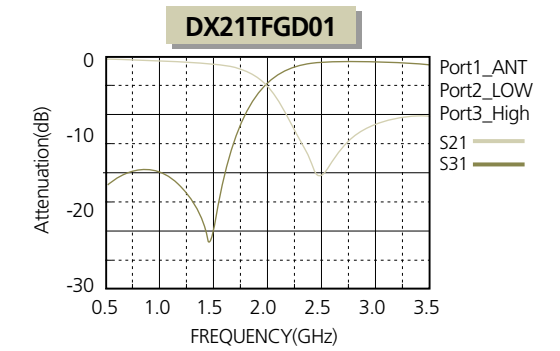
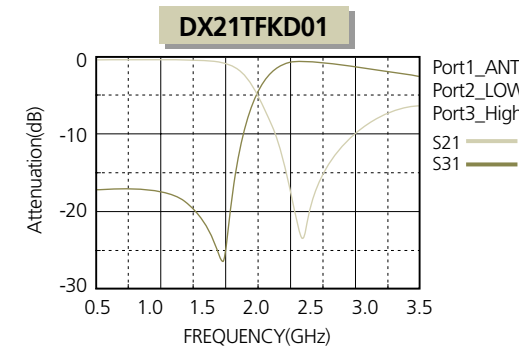
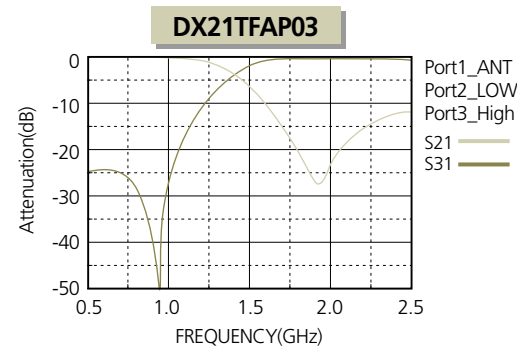
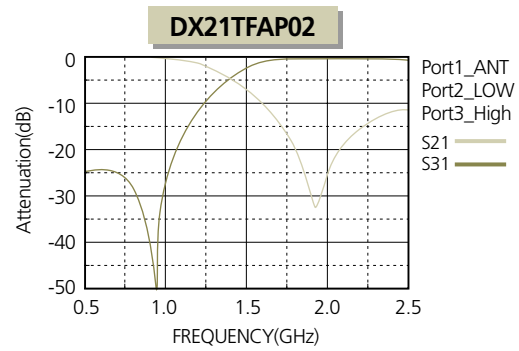
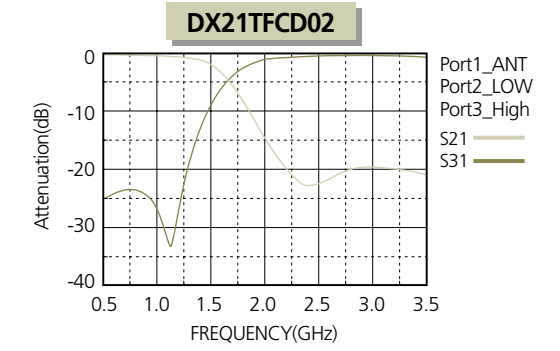
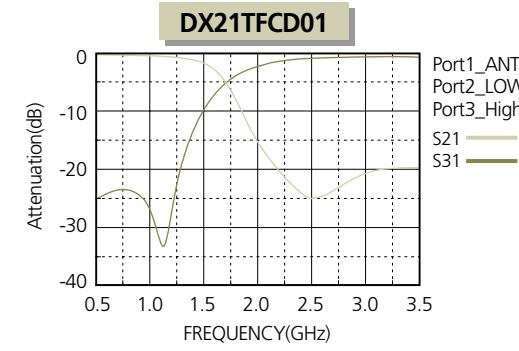
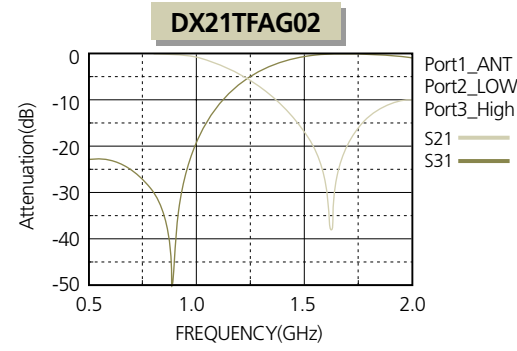
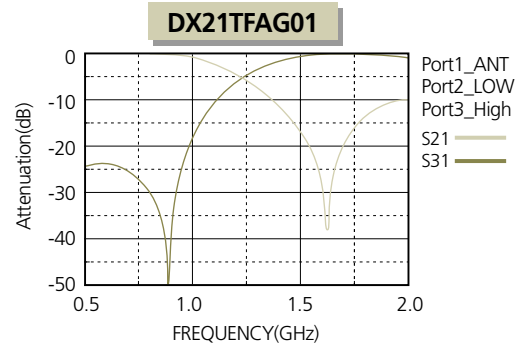

Diplexer

Characteristics

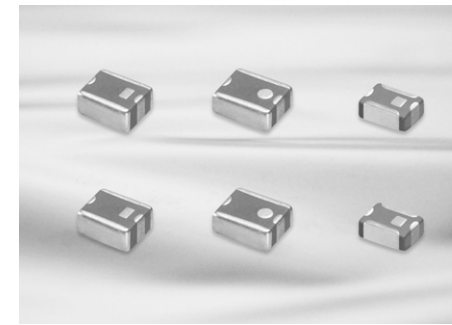
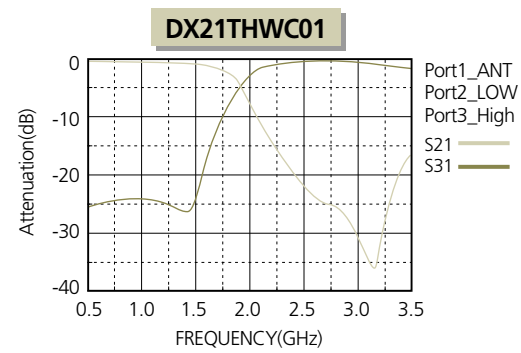
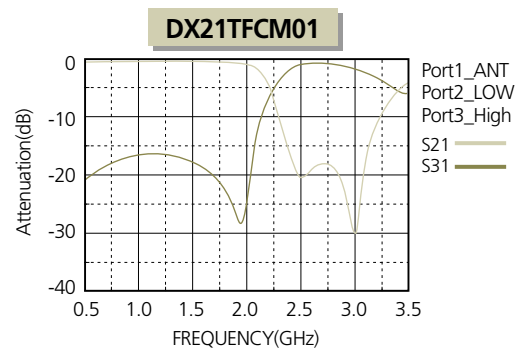
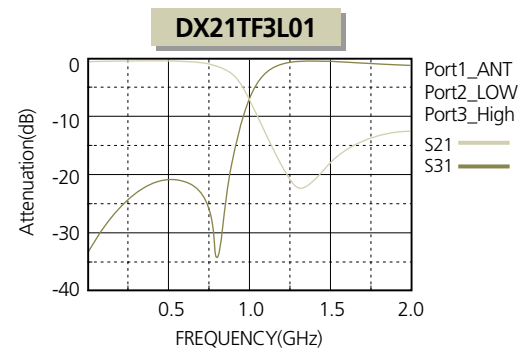
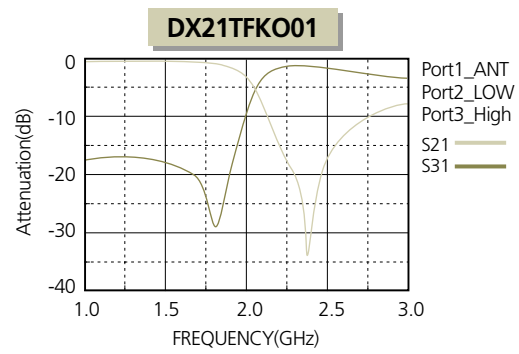
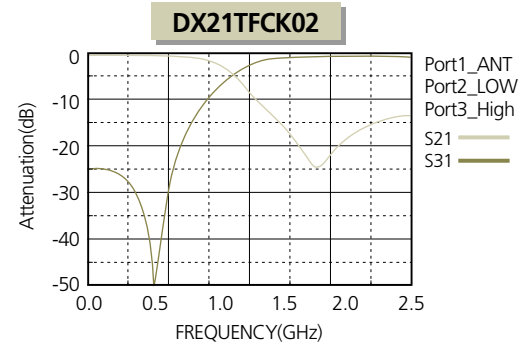
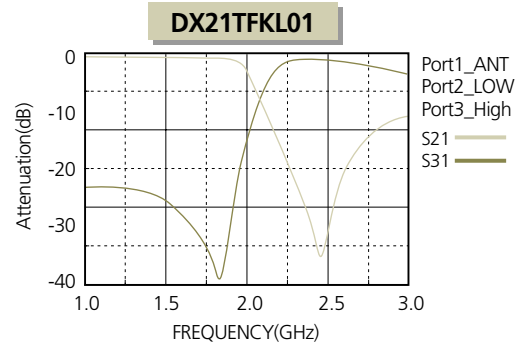

Feature

- High Attenuation, Low Insertion Loss
- Small and Thin size
- Lead free

Application

- Bluetooth Module
- W-LAN Module
- HHP-WiBro, WiMAX, DMB

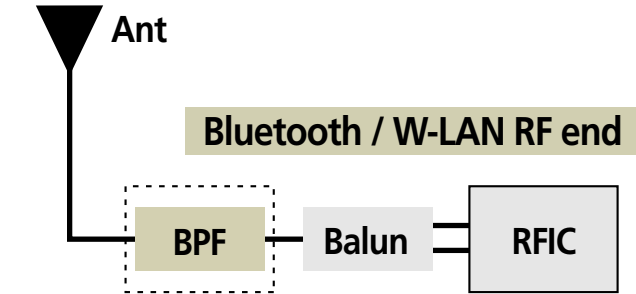

Chip LC filter made by our own RF design and LTCC fabrication technology has excellent products with low loss and good attenuation characteristics

Part Numbering

LC	B	10	C	2450	K1
(1)	(2)	(3)	(4)	(5)	(6)

- (1) Chip LC Filter
- (2) B: Band Pass Filter, L : Low Pass Filter
- (3) Dimension (10 : 1.6x0.8mm, 21 : 2.0x1.25mm)
- (4) Material code (C, M, T)
- (5) Center frequency [MHz]
- (6) Serial Number

Band Pass Filter

Application	Part No.	L×W×T (mm)	Pass Band (GHz)	IL (dB) Max.	VSWR (dB) Min.	Attenuation (dB) Min. (at MHz)			
11b/g BT	LCB32B2450A2	3.2×2.5×1.5	2.4~2.5	1.8	2.0	48 (902~928)	50 (1500~1550)	12 (2150~2200)	30 (2f0)
	LCB32B2450A3	3.2×2.5×1.25	2.4~2.5	1.8	2.0	48 (902~928)	50 (1500~1550)	12 (2150~2200)	30 (2f0)
	LCB22M2450B1	2.5×2.0×1.0	2.4~2.5	1.2	2.0	50 (1200)	30 (2f0)		
	LCB22B2450L1	2.5×2.0×1.0	2.4~2.5	2.2	2.0	40 (2100)	30 (2f0)		
	LCB22B2450S1	2.5×2.0×1.0	2.4~2.5	2.5	2.0	20 (1700~1900)	20 (2700)	30 (2f0)	15 (3f0)
	LCB21B2450F2	2.0×1.25×0.75	2.4~2.5	2.6	2.0	40 (880~960)	30 (1710~1990)	30 (2f0)	35 (2f0)
	LCB21B2450Q1	2.0×1.25×0.95	2.4~2.5	1.8	2.0	30 (1300)	10 (2000)	20 (3600)	30 (2f0)
	LCB21B2450Q3	2.0×1.25×0.75	2.4~2.5	1.8	2.0	30 (1300)	10 (2000)	15 (3600)	20 (3f0)
	LCB10C2450K1	1.6×0.8×0.6	2.4~2.5	2.5	2.0	35 (880~960)	12 (1710~1990)	16 (2f0)	20 (3f0)
LCB10B2450K3	1.6×0.8×0.6	2.4~2.5	2.2	2.0	25 (880~960)	16 (2f0)	20 (3f0)		
11a	LCB21M5425A1	2.0×1.25×0.95	4.90~5.95	1.8	2.2	30 (3900~4000)	5 (2f0)		
T-DMB	LCB22G0205A3	2.5×2.0×1.2	0.174~0.237	1.5	2.0	10 (100)	40 (1750~1870)		
	LCB22G0205B3	2.5×2.0×1.2	0.174~0.237	1.5	2.0	10 (100)	40 (824~894)		

Low Pass Filter

Application	Part No.	L×W×T (mm)	Pass Band (GHz)	IL (dB) Max.	VSWR (dB) Min.	Attenuation (dB) Min. (at MHz)		
11b/g BT	LCL21T2450B1	2.0×1.25×0.95	2.4~2.5	0.5	1.5	27 (2f0)	25 (3f0)	25 (4f0)
WiBro WiMAX	LCL10T2500A1	1.6×0.8×0.6	2.3~2.7	0.55	1.7	(2f0)	25 (3f0)	

Dimensions & Frequency Characteristics Band Pass Filter

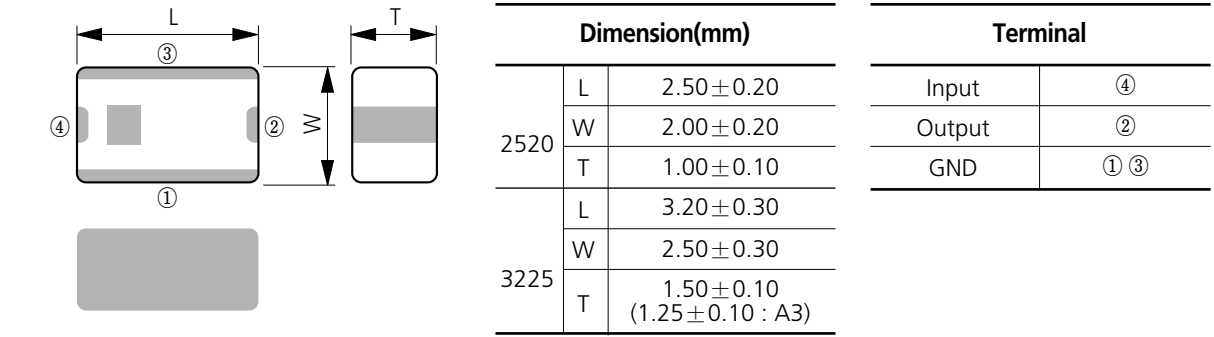

S11
S21

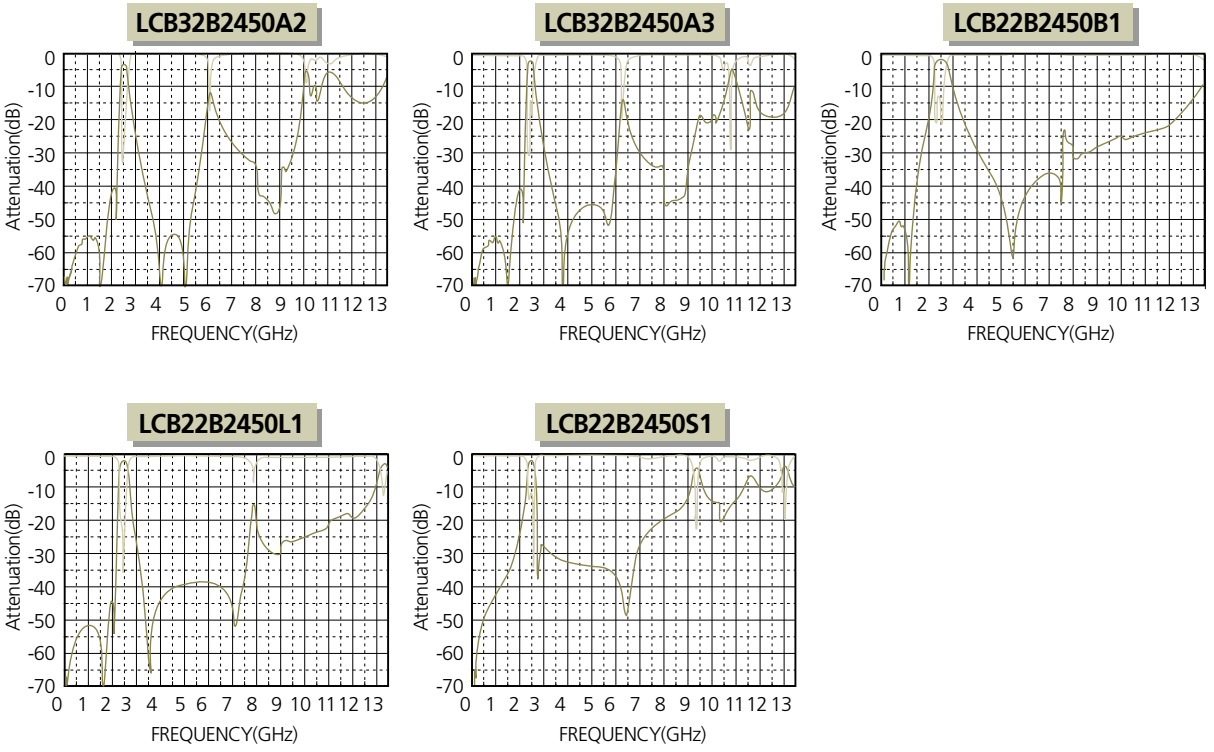

LC Filter

Dimensions & Frequency Characteristics Band Pass Filter

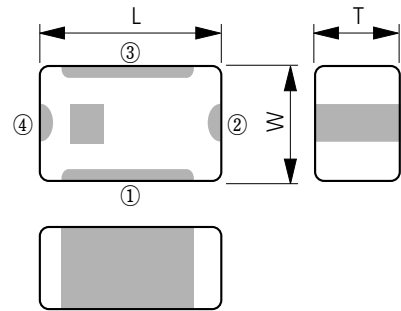

		Dimension(mm)		Terminal	
1608	L	1.60±0.2/-0.1		Input	④
	W	0.80±0.2/-0.1		Output	②
	T	0.60±0.10		GND	① ③
2012	L	2.00±0.15			
	W	1.25±0.10			
	T	0.95±0.10 (0.75max : Q3, Q5)			

S11
S21

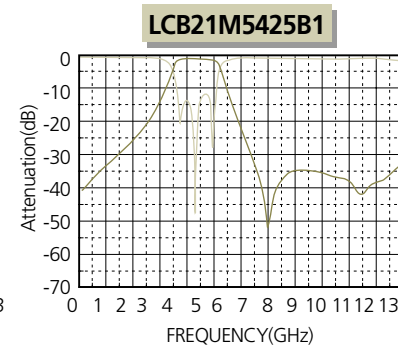
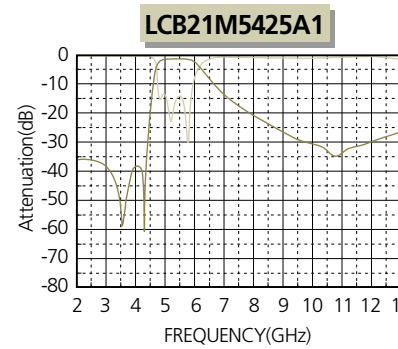
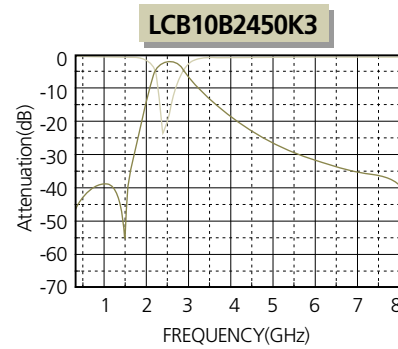
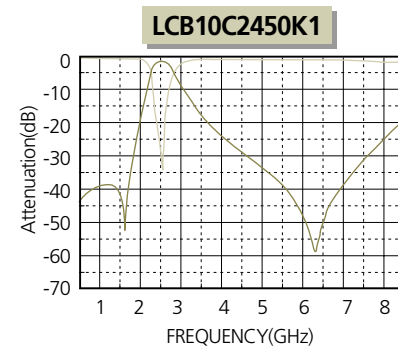
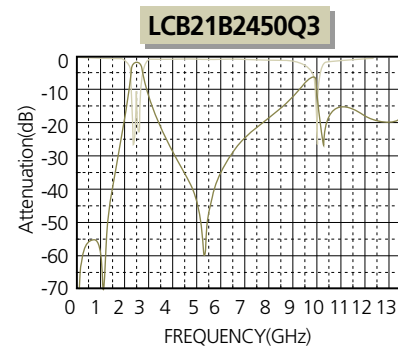
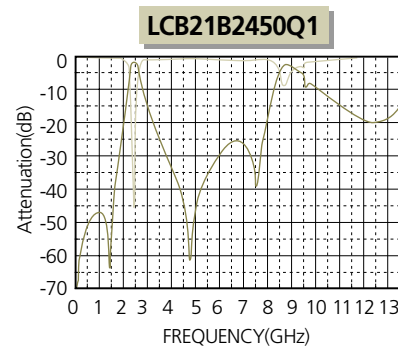

Dimensions & Frequency Characteristics Band Pass Filter

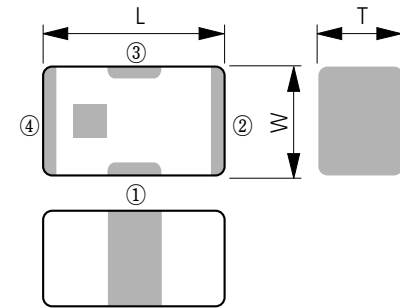

		Dimension(mm)		Terminal	
2012	L	2.00±0.15		Input	①
	W	1.25±0.10		Output	③
	T	0.75max		GND	② ④

S11
S21

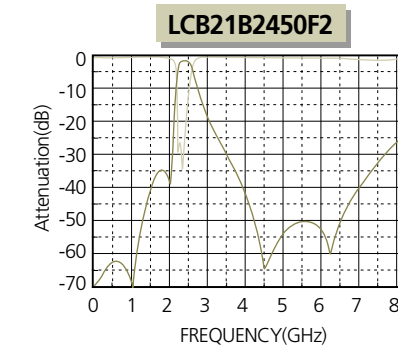

Dimensions & Frequency Characteristics Band Pass Filter

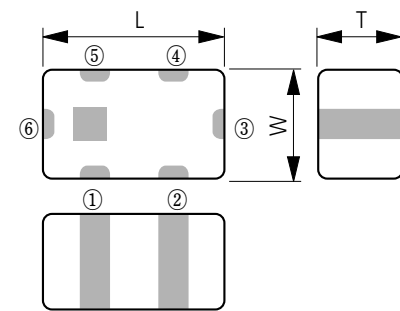

		Dimension(mm)		Terminal		
				A3	B3	
2520	L	2.50±0.20		Input	⑥	⑥
	W	2.00±0.20		Output	③	③
	T	1.20±0.15		GND	① ⑤	① ④
				N.C	② ④	② ⑤

S11
S21

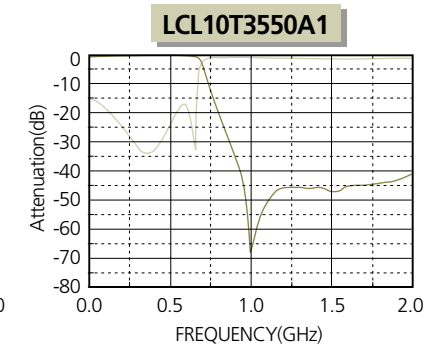
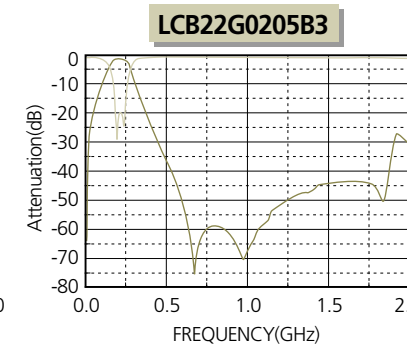
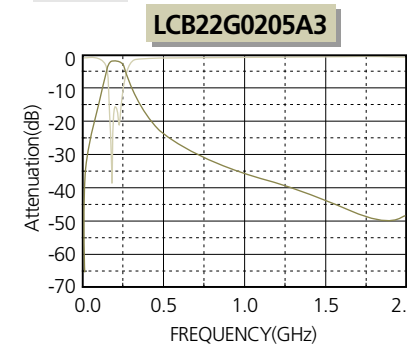

Dimensions & Frequency Characteristics Low Pass Filter

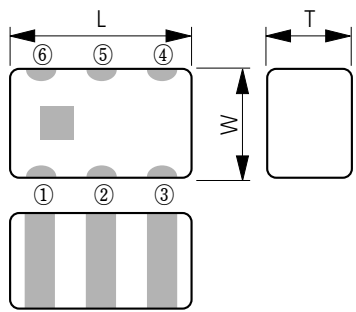

Dimension(mm)		Terminal		
1608	L	1.60±0.10	Input	②
	W	0.80±0.10	Output	⑤
	T	0.60±0.10	BND	① ③ ④ ⑥

S11
S21

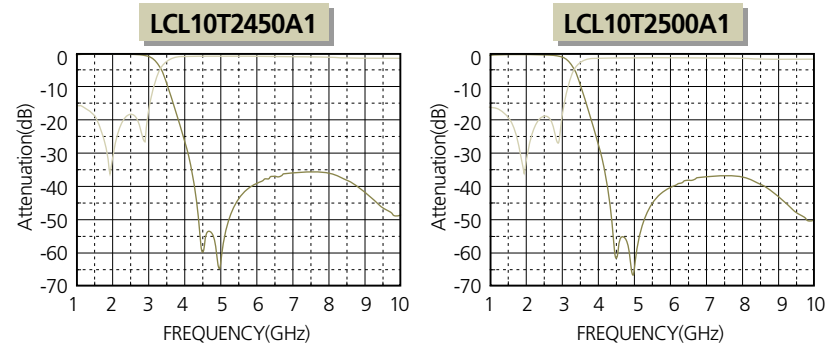

Dimensions & Frequency Characteristics Low Pass Filter

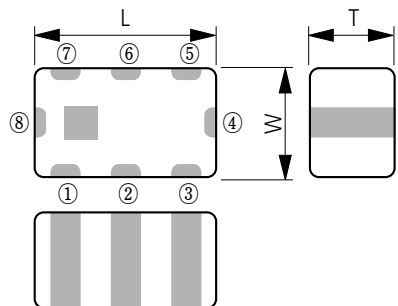

Dimension(mm)		Terminal		
2012	L	2.00±0.15	Input	⑧
	W	1.25±0.15	Output	④
	T	0.95±0.10	N.C	② ⑥
		GND	① ③ ⑤ ⑦	

S11
S21

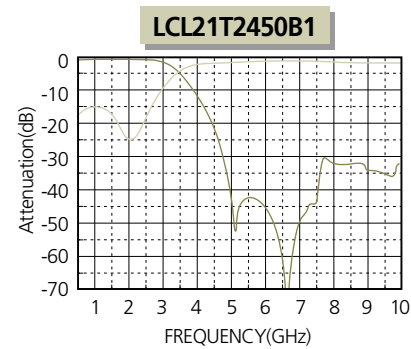

Soldering Condition

REFLOW SOLDERING

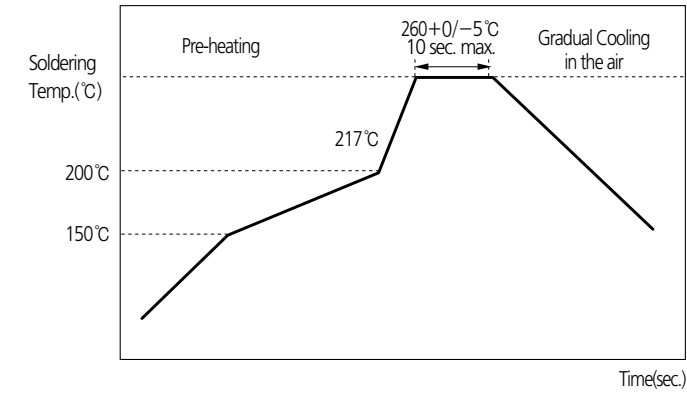

FLOW SOLDERING

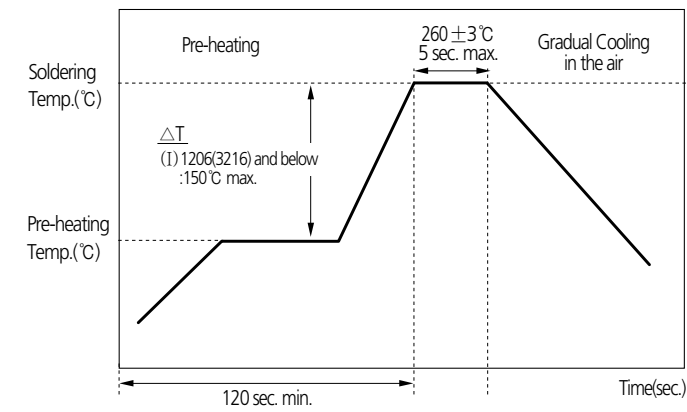

SOLDER IRON(Hand Soldering)

Variation of Temp.(°C)	Soldering Temp(°C)	Pre-heating Time(sec)	Soldering Time(sec)	Cooling Time(sec)	Condition of Iron Facilities		
					Wattage	Tip Diameter	Soldering Time
ΔT≤130	300±10°Cmax	≥ 60 sec.	≤ 4 sec.	-	20W max	3mm max	4 sec max

Packaging

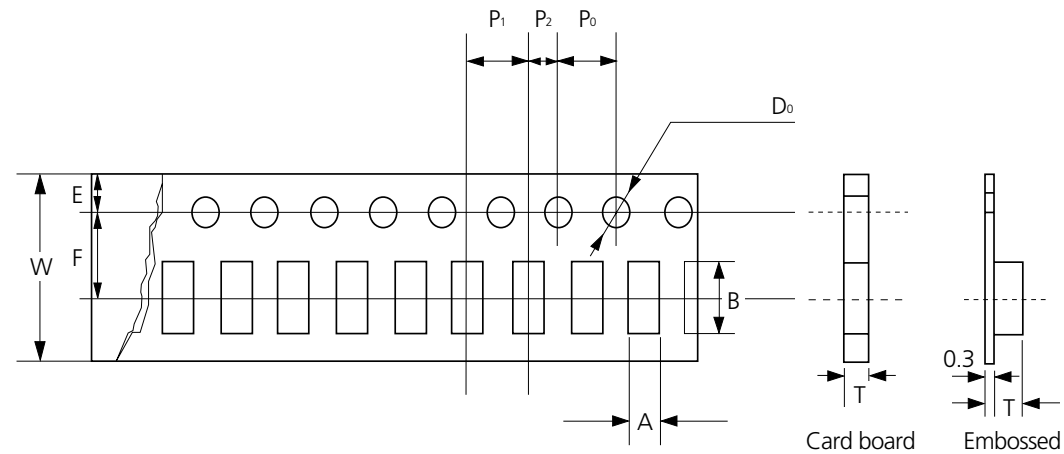

Unit: mm

Type	03	05	10	21			22	31			32	41	43		
Tape	Card	Card	Card	Embossed			Card	Embossed	Embossed			Card	Embossed	Embossed	
Chip Thickness	0.3	0.5	0.8	0.85	1.0	1.25	0.85	1.2	0.6	0.8	1.1	0.85	1.3	1.6 (1.2)	1.5
Chip Cavity	A	0.40 ±0.06	0.65 ±0.1	1.0 ±0.2	1.5 ±0.2	1.5 ±0.2	1.45 ±0.1	2.39 ±0.10	1.9 ±0.2	1.9 ±0.2	1.9 ±0.2	2.0 ±0.2	2.9 ±0.2	1.9 ±0.2	3.5 ±0.2
	B	0.70 ±0.06	1.15 ±0.1	1.8 ±0.2	2.3 ±0.2	2.3 ±0.2	2.3 ±0.2	2.4 ±0.2	2.79 ±0.10	3.6 ±0.2	3.6 ±0.2	3.6 ±0.2	3.6 ±0.2	3.6 ±0.2	4.9 ±0.2
t max	0.45	0.8	1.1	1.5	2.0	2.0	0.95 ±0.1	1.80 ±0.10	1.15	1.4	1.4	1.1	1.55	1.8	1.78
W	8 ±0.2	8 ±0.2	8 ±0.2	8 ±0.2	8 ±0.2	8 ±0.2	8.0 ±0.3	8.0 ±0.3	8 ±0.2	8 ±0.2	8 ±0.2	8 ±0.2	8 ±0.2	12 ±0.2	12 ±0.2
F	3.5 ±0.05	3.5 ±0.05	3.5 ±0.05	3.5 ±0.05	3.5 ±0.05	3.5 ±0.05	3.5 ±0.05	3.5 ±0.05	3.5 ±0.05	3.5 ±0.05	3.5 ±0.05	3.5 ±0.05	3.5 ±0.05	5.5 ±0.05	5.5 ±0.05
E	1.75 ±0.1	1.75 ±0.1	1.75 ±0.1	1.75 ±0.1	1.75 ±0.1	1.75 ±0.1	1.75 ±0.1	1.75 ±0.1	1.75 ±0.1	1.75 ±0.1	1.75 ±0.1	1.75 ±0.1	1.75 ±0.1	1.75 ±0.1	1.75 ±0.1
P ₁	2 ±0.05	2 ±0.05	4.0 ±0.1	4.0 ±0.1	4.0 ±0.1	4.0 ±0.1	4.0 ±0.1	4.0 ±0.1	4.0 ±0.1	4.0 ±0.1	4.0 ±0.1	4.0 ±0.1	4.0 ±0.1	8.0 ±0.1	8.0 ±0.1
P ₂	2 ±0.1	2 ±0.1	2 ±0.1	2 ±0.1	2 ±0.1	2 ±0.1	2.0 ±0.1	2.0 ±0.05	2 ±0.1	2 ±0.1	2 ±0.1	2 ±0.1	2 ±0.1	2 ±0.1	2 ±0.1
P ₀	4.0 ±0.1	4.0 ±0.1	4.0 ±0.1	4.0 ±0.1	4.0 ±0.1	4.0 ±0.1	4.0 ±0.1	4.0 ±0.1	4.0 ±0.1	4.0 ±0.1	4.0 ±0.1	4.0 ±0.1	4.0 ±0.1	4.0 ±0.1	4.0 ±0.1
D ₀	∅1.5 ±0.1	∅1.5 ±0.1	∅1.5 ±0.1	∅1.5 ±0.1	∅1.5 ±0.1	∅1.5 ±0.1	∅1.5 ±0.1 /0	∅1.5 ±0.1	∅1.5 ±0.1	∅1.5 ±0.1	∅1.5 ±0.1	∅1.5 ±0.1 /0	∅1.5 ±0.1	∅1.5 ±0.1	∅1.5 ±0.1
Quantity /Reel (PCS)	10,000	10,000	4,000	4,000	3,000	2,000	4,000	2,000	4,000	3,000	3,000	4,000	2,500	2,000 (3,000)	1,000

• Reel dimensions

Unit: mm

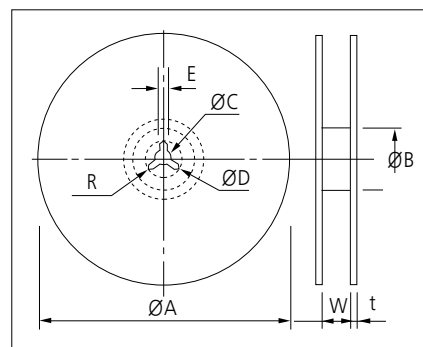

Symbol	A	B	C	D
7" Reel	∅180+0/-3	∅60+1/-0	∅13±0.3	25±0.5
13" Reel	∅330±2.0	∅80±1.0	∅13±0.3	25±0.5

Symbol	E	W	t	R
7" Reel	2.0±0.5	9±0.5	1.2±0.2	1.0
13" Reel	2.0±0.5	9±0.5	2.2±0.2	1.0

Products in this catalog are recommended using general purpose.
For using special purpose like Military, Medical, Aviation, Automobile device should be following a special specification.