

Socket

Header

Compliance with RoHS Directive

FEATURES

1. The world's slimmest* two-piece connectors having a 2.5 mm width

*Our company research in September 2008

The ultra-compact and slim body contributes to further miniaturization and functionality enhancement of target equipment.

<Compared with our existing model (F4S, 40 contacts, when mated)>

- Width: 30% down
- Footprint: 30% down

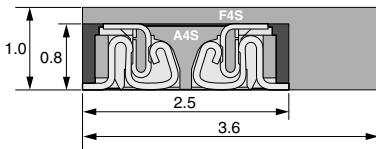

2. "TOUGH CONTACT ADVANCED" structure adopted to ensure high resistance to various environments in spite of the ultra-slim and low profile body
(See Page 6 for details of the structure)

3. The simple lock structure gives tactile feedback that ensures a superior mating/unmating operation feel.

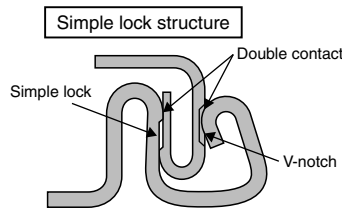

The connector gives the tactile feedback when inserted, allowing reliable mating.

4. Gull-wing terminal structure

The gull-wing terminals facilitate inspection of mounting results using an automatic recognition system.

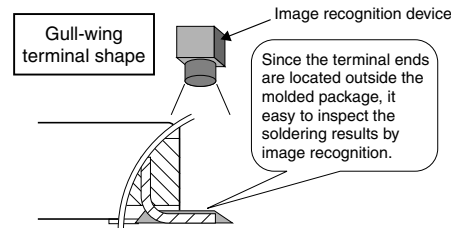

5. Connectors for inspection available

Connectors for inspection are available that are ideal for modular unit inspection and inspection in device assembly processes.

APPLICATIONS

Recommended for board-to-FPC connections of mobile equipment, such as cellular phones, smart phones, notebook PCs, and portable music players

Example of Board-to-FPC connections

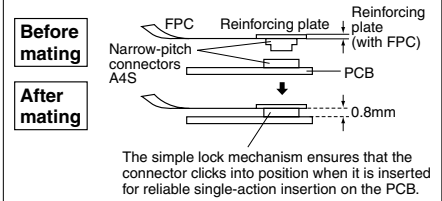

ORDERING INFORMATION

5: Narrow Pitch Connector A4S (0.4 mm pitch) Socket
6: Narrow Pitch Connector A4S (0.4 mm pitch) Header

Number of contacts (2 digits)

Mated height

<Socket>

1: For mated height 0.8 mm

<Header>

1: For mated height 0.8 mm

Functions

<Socket, Header>

2: Without positioning bosses

Surface treatment (Contact portion / Terminal portion)

<Socket>

4: Ni plating on base, Au plating on surface (for Ni barrier available)

<Header>

4: Ni plating on base, Au plating on surface

AXE

PRODUCT TYPES  **TOUGH CONTACT ADVANCED**

Mated height	Number of contacts	Part number		Packing	
		Socket	Header	Inner carton	Outer carton
0.8mm	10	AXE510124	AXE610124	5,000 pieces	10,000 pieces
	12	AXE512124	AXE612124		
	14	AXE514124	AXE614124		
	16	AXE516124	AXE616124		
	18	AXE518124	AXE618124		
	20	AXE520124	AXE620124		
	22	AXE522124	AXE622124		
	24	AXE524124	AXE624124		
	26	AXE526124	AXE626124		
	28	AXE528124	AXE628124		
	30	AXE530124	AXE630124		
	32	AXE532124	AXE632124		
	34	AXE534124	AXE634124		
	36	AXE536124	AXE636124		
	38	AXE538124	AXE638124		
	40	AXE540124	AXE640124		
	50	AXE550124	AXE650124		
60	AXE560124	AXE660124			
64	AXE564124	AXE664124			
70	AXE570124	AXE670124			
80	AXE580124	AXE680124			

- Notes: 1. Order unit: For mass production: in 1-inner-box (1-reel) units
 Samples for mounting check: in 50-connector units. Please contact our sales office.
 Samples: Small lot orders are possible. Please contact our sales office.
 2. The above part numbers are for connectors without positioning bosses, which are standard. When ordering connectors with positioning bosses, please contact our sales office.
 3. Please contact us for connectors having a number of contacts other than those listed above.

SPECIFICATIONS

1. Characteristics

	Item	Specifications	Conditions
Electrical characteristics	Rated current	0.3A/contact (Max. 5 A at total contacts)	
	Rated voltage	60V AC/DC	
	Breakdown voltage	150V AC for 1 min.	No short-circuiting or damage at a detection current of 1 mA when the specified voltage is applied for one minute.
	Insulation resistance	Min. 1,000MΩ (initial)	Using 250V DC megger (applied for 1 min.)
	Contact resistance	Max. 90mΩ	Based on the contact resistance measurement method specified by JIS C 5402.
Mechanical characteristics	Composite insertion force	Max. 1.200N/contacts × contacts (initial)	
	Composite removal force	Min. 0.165N/contacts × contacts	
Environmental characteristics	Contact holding force (Socket contact)	Min. 0.20N/contacts	Measuring the maximum force. As the contact is axially pull out.
	Ambient temperature	-55°C to +85°C	No freezing at low temperatures. No dew condensation.
	Soldering heat resistance	Peak temperature: 260°C or less (on the surface of the PC board around the connector terminals)	Infrared reflow soldering
		300°C within 5 sec. 350°C within 3 sec.	Soldering iron
	Storage temperature	-55°C to +85°C (product only) -40°C to +50°C (emboss packing)	No freezing at low temperatures. No dew condensation.
	Thermal shock resistance (header and socket mated)	5 cycles, insulation resistance min. 100MΩ, contact resistance max. 90mΩ	Sequence 1. -55 ³ / ₃ °C, 30 minutes 2. ~, Max. 5 minutes 3. 85 ³ / ₃ °C, 30 minutes 4. ~, Max. 5 minutes
	Humidity resistance (header and socket mated)	120 hours, insulation resistance min. 100MΩ, contact resistance max. 90mΩ	Bath temperature 40±2°C, humidity 90 to 95% R.H.
Saltwater spray resistance (header and socket mated)	24 hours, insulation resistance min. 100MΩ, contact resistance max. 90mΩ	Bath temperature 35±2°C, saltwater concentration 5±1%	
H ₂ S resistance (header and socket mated)	48 hours, contact resistance max. 90mΩ	Bath temperature 40±2°C, gas concentration 3±1 ppm, humidity 75 to 80% R.H.	
Lifetime characteristics	Insertion and removal life	30 times	Repeated insertion and removal speed of max. 200 times/hours
Unit weight		50-contact type: Socket: 0.03 g Header: 0.01 g	

AXE5, 6

2. Material and surface treatment

Part name	Material	Surface treatment
Molded portion	LCP resin (UL94V-0)	—
Contact and Post	Copper alloy	Contact portion: Base: Ni plating Surface: Au plating Terminal portion: Base: Ni plating Surface: Au plating (except the terminal tips) Metal clips: Sockets: Base: Ni plating Surface: Pd+Au flash plating (except the terminal tips) Headers: Base: Ni plating Surface: Au plating (except the terminal tips)

DIMENSIONS (Unit: mm)

The CAD data of the products with a **CAD Data** mark can be downloaded from: <http://panasonic-electric-works.net/ac>

Socket (Mated height: 0.8 mm)

CAD Data

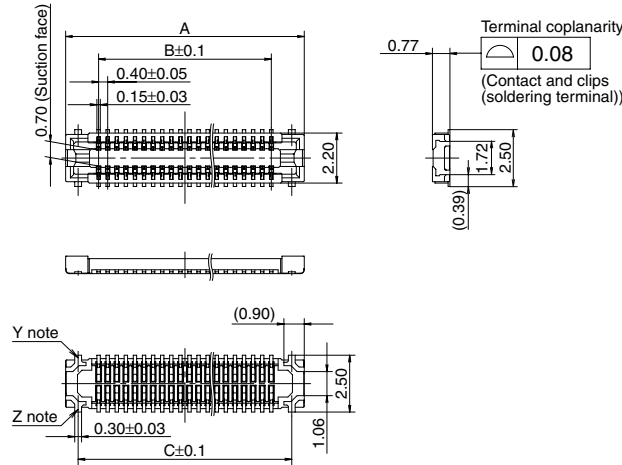

General tolerance: ±0.2

Note: Since the clip (soldering terminal) has a single-piece construction, sections Y and Z are electrically connected.

Dimension table (mm)

Number of contacts/ dimension	A	B	C
10	4.5	1.6	3.4
12	4.9	2.0	3.8
14	5.3	2.4	4.2
16	5.7	2.8	4.6
18	6.1	3.2	5.0
20	6.5	3.6	5.4
22	6.9	4.0	5.8
24	7.3	4.4	6.2
26	7.7	4.8	6.6
28	8.1	5.2	7.0
30	8.5	5.6	7.4
32	8.9	6.0	7.8
34	9.3	6.4	8.2
36	9.7	6.8	8.6
38	10.1	7.2	9.0
40	10.5	7.6	9.4
50	12.5	9.6	11.4
60	14.5	11.6	13.4
64	15.3	12.4	14.2
70	16.5	13.6	15.4
80	18.5	15.6	17.4

Header (Mated height: 0.8 mm)

CAD Data

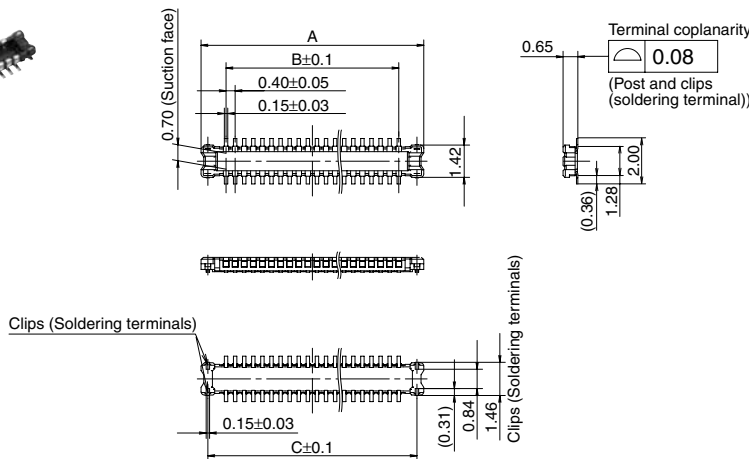

General tolerance: ±0.2

Dimension table (mm)

Number of contacts/ dimension	A	B	C
10	3.8	1.6	3.2
12	4.2	2.0	3.6
14	4.6	2.4	4.0
16	5.0	2.8	4.4
18	5.4	3.2	4.8
20	5.8	3.6	5.2
22	6.2	4.0	5.6
24	6.6	4.4	6.0
26	7.0	4.8	6.4
28	7.4	5.2	6.8
30	7.8	5.6	7.2
32	8.2	6.0	7.6
34	8.6	6.4	8.0
36	9.0	6.8	8.4
38	9.4	7.2	8.8
40	9.8	7.6	9.2
50	11.8	9.6	11.2
60	13.8	11.6	13.2
64	14.6	12.4	14.0
70	15.8	13.6	15.2
80	17.8	15.6	17.2

• Socket and Header are mated

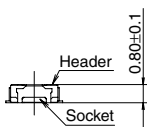

EMBOSSED TAPE DIMENSIONS (Unit: mm) (Common to all sockets and headers)

• Specifications for taping

(In accordance with JIS C 0806-1990. However, not applied to the mounting-hole pitch of some connectors.)

• Specifications for the plastic reel

(In accordance with EIAJ ET-7200B.)

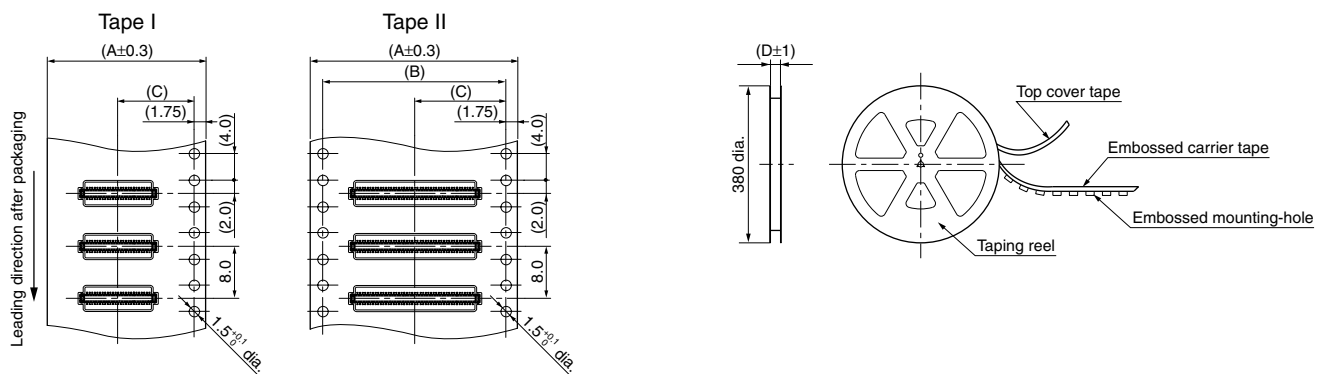

• Dimension table (Unit: mm)

Type/Mated height	Number of contacts	Type of taping	A	B	C	D	Quantity per reel
Common for sockets and headers/ 0.8 mm	24 or less	Tape I	16.0	—	7.5	17.4	5,000
	26 to 70	Tape I	24.0	—	11.5	25.4	5,000
	80	Tape II	32.0	28.4	14.2	33.4	5,000

• Connector orientation with respect to embossed tape feeding direction

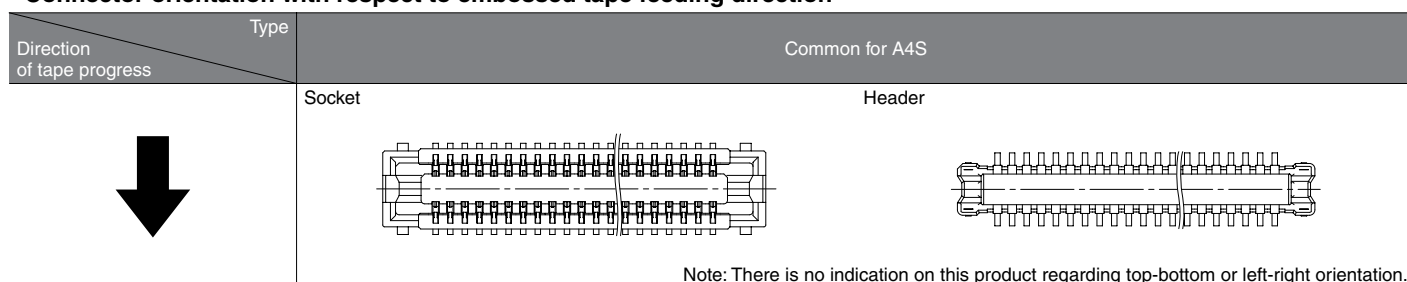

Note: There is no indication on this product regarding top-bottom or left-right orientation.

TABLE OF PRODUCT TYPES

☆: Available for sale

Product name	A4S for inspection
10	☆
12	☆
14	☆
16	☆
18	☆
20	☆
22	☆
24	☆
26	☆
28	☆
30	☆
32	☆
34	☆
36	☆
38	☆
40	☆
50	☆
60	☆
64	☆
70	☆
80	☆

Notes:

1. Please inquire about numbers of contacts other than those given above.
2. Please inquire with us regarding delivery times.
3. Please keep the minimum unit for ordering no less than 50 pieces per lot.
4. Please inquire for further information.

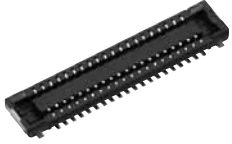

Socket



Header

Compliance with RoHS Directive

FEATURES

1. 3,000 insertion and removals (when as recommended)

From the 30 insertion and removals of standard type, up to 3,000 insertion and removals (with recommended insertion and removal) are possible for use in inspection.

Ideal for inspection of module units and inspection during the device assembly process

2. Same external dimensions and foot pattern as standard type.

Since shape is the same as standard type, inspection is possible without interfering with devices in the vicinity of standard connectors.

3. Improved mating

Insertion and removal have become easier due to a reduction in the mating retention force required by the simple locking structure and also in the amount of force needed for insertion and removal. (We cannot warrant anything regarding mating retention.)

PRODUCT TYPES

Specifications		Part No.	Specifications		Part No.
Socket	Without positioning bosses	AXE5E**26	Header	Without positioning bosses	AXE6E**26

Note: When placing an order, substitute the "*" (asterisk) in the above part number with the number of contacts for the required connector.

NOTES

1. If extra resistance to drop impact is required for ultra-low profile type connectors, we recommend using our F4 or F4S series.

2. Recommended PC board and metal mask patterns

Appropriate control of solder amount is required to minimize solder bridges and other defects for connectors with 0.4-mm or 0.5-mm pitch terminals, which require high-density mounting. Refer to the right-hand drawing for recommended patterns.

• Socket

Recommended PC board pattern (TOP VIEW)

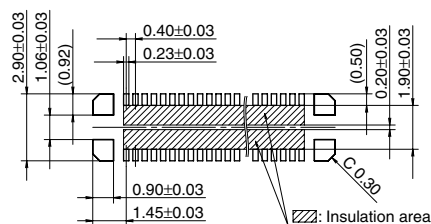

Recommended metal mask opening pattern

Metal mask thickness: When 120 μ m
(Terminal opening ratio: 70%)
(Metal-part opening ratio: 100%)

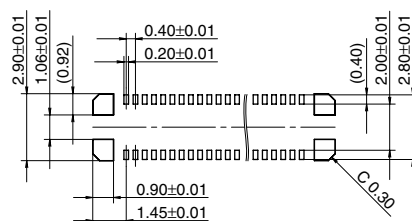

• Header

Recommended PC board pattern (TOP VIEW)

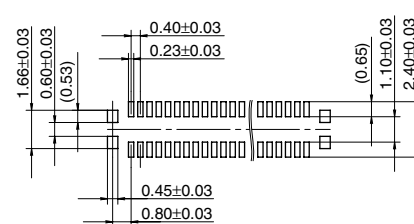

Recommended metal mask opening pattern

Metal mask thickness: When 120 μ m
(Terminal opening ratio: 70%)
(Metal-part opening ratio: 100%)

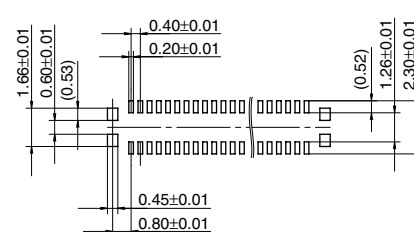

For other details, please verify with the product specification sheets.