

160-2100 Solder terminal, turreted, thru hole

Recommended mounting hole .067 (1,70), #51 drill

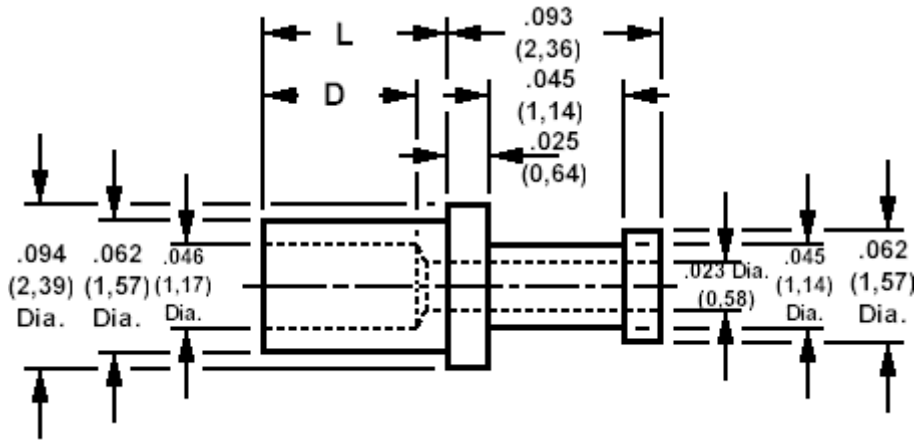

How to order code

160-2100-XX-YY-00

Basic Part No XX = L dimension YY = Plating Finish

DIMENSIONS (XX)				
Basic Part No	(XX)	L	Board Thickness	D
160-2100	-11	.025 (0,64)	.016 (0,40)	.020 (0,51)
	-01	.045 (1,14)	.031 (0,79)	.040 (1,02)
	-02	.094 (2,39)	.062 (1,59)	.089 (2,26)
	-03	.125 (3,18)	.094 (2,38)	.089 (2,26)

MATERIALS			
Component	Material	Finish (YY)	
Terminal	Brass	-01	-05
		Silver	Electro Solder

SWAGE TOOLING		
Recommended Swaging Tools:-		Notes
Anvil	435-6411-01-00-00	
Roll punch	435-6611-01-00-00	
Flare Punch	435-6657-01-00-00	For 160-2100-11/01
Flare Punch	435-6692-01-00-00	For 160-2100-02/03