

Surface Mount Ceramic Chip Antennas for 868 MHz



VJ5601M868MXBSR chip antenna product

Vishay VJ5601M868MXBSR chip antennas are covered by one or more of the following patents:

WO2008250262 (A1), US2008303720 (A1), US2008305750 (A1), WO2008154173 (A1)

Other patents are pending.

DESCRIPTION

The VJ5601M868MXBSR ceramic chip antenna is a small form-factor, high-performance, chip-antenna designed for operation at 868 MHz. It allows manufacturers to design high quality products that do not bear the penalty of a large external antenna, and is designed to be assembled onto a PC board using a standard reflow process.

The VJ5601M868 is the latest in a family of products developed by Vishay, a world leader in manufacturing of discrete and passive components.

The VJ5601M868 series are small form-factor, high-performance chip-antennas optimized for medical, remote sensing, industrial, security, and RFID applications. Utilizing unique Vishay materials and manufacturing technologies, these products when properly tuned also comply with the MBRAI standard for portable communication.

FEATURES

- Small outline (15.5 mm x 10.5 mm x 1.2 mm)
- 50 Ω unbalanced tuning interface (max. 1.73 dBi gain ⁽¹⁾)
- Assembled onto a PCB in the standard reflow process
- 140 MHz half-power tuned bandwidth (800 to 940 MHz)
- High-reliability ceramic-oxide body construction
- Low-RF loss, high-Q ceramic
- Lead (Pb)-free/wet build process
- Reliable Noble Metal Electrode (NME) system
- Wide operating temperature range (- 40 °C to + 85 °C)
- Material categorization: For definitions of compliance please see www.vishay.com/doc?99912



RoHS
COMPLIANT
HALOGEN
FREE

Note

⁽¹⁾ See figures 1 through 6 for more details on the radiation pattern (antenna gain) at 868 MHz; the PCB board ground is shorted to earth ground for tuning.

APPLICATIONS

- Medical telemetry (internal/external)
- Remote sensing and control
- Industrial automation and telemetry
- Security systems, home automation
- Long range RFID

ELECTRICAL SPECIFICATIONS

Operating temperature: - 40 °C to + 85 °C

Frequency range (transmission/reception): 800 MHz to 940 MHz

Note

• Electrical characteristics at + 25 °C unless otherwise specified. Antenna performance is measured at 868 MHz and 50 Ω impedance unless otherwise specified. The best results are obtained by mounting the chip following the layout guidelines application note for the evaluation kit.

QUICK REFERENCE DATA					
SERIES	FREQUENCY (MHz)	MAX. GAIN (dBi)	AVERAGE GAIN (dBi)	BANDWIDTH (- 10 dB) (MHz)	BANDWIDTH (- 3 dB) (MHz)
VJ5601M868MXBSR	868	3.2	0.2	38	140

CHIP ANTENNA PERFORMANCE									
NOMINAL FREQUENCY (MHz)	NOMINAL IMPEDANCE (Ω)	868 MHz AVERAGE GAIN (dBi)	868 MHz PEAK GAIN (dBi)	REFLECTED POWER COEFFICIENT S11	868 MHz REFLECTED POWER LOSS	- 3 dB BANDWIDTH 800 MHz to 940 MHz (MHz)	- 3 dB REFLECTED POWER LOSS	- 10 dB BANDWIDTH 849 MHz to 887 MHz (MHz)	- 10 dB REFLECTED POWER LOSS
868	50	0.2	3.2	< - 22 dB	0.6 %	140	50 %	38	10 %
				0.6 %	< 0.03 dB		3 dB		0.46 dB

VJ5601M868MXBSR TUNING

Final tuning configuration and component values for L1, L2, and C1 depend on customer PCB layout. Optimal tuning is possible with just a few standard components. The nominal values shown are for a tuned VJ5601M868MXBEK kit.

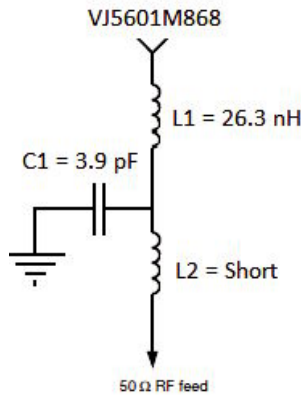

Fig. 1 - Tuning Example with Inductors L1, L2 and Capacitor C1

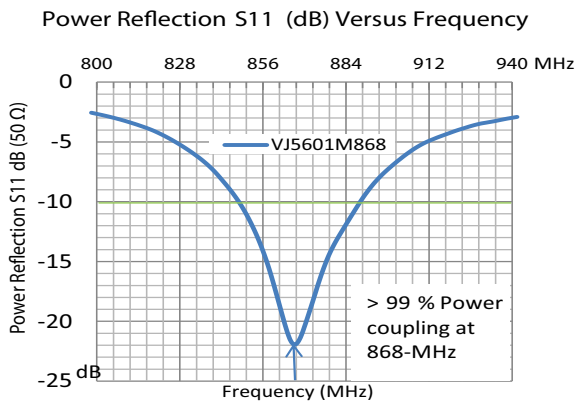

Fig. 2 - VJ5601M868 Tuned to 868 MHz with > 99 % Power Coupled

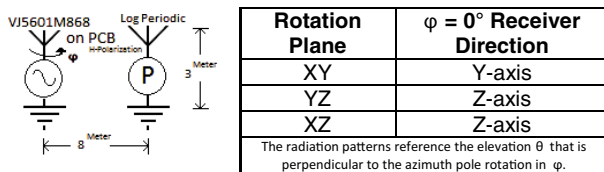

Fig. 3 - VJ5601M868 PCB Mounting and Coordinate Directions

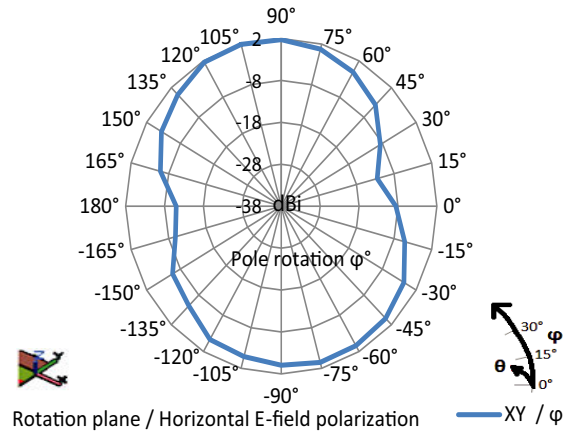

Fig. 4 - VJ5601M868MXBSR XY Radiation Pattern

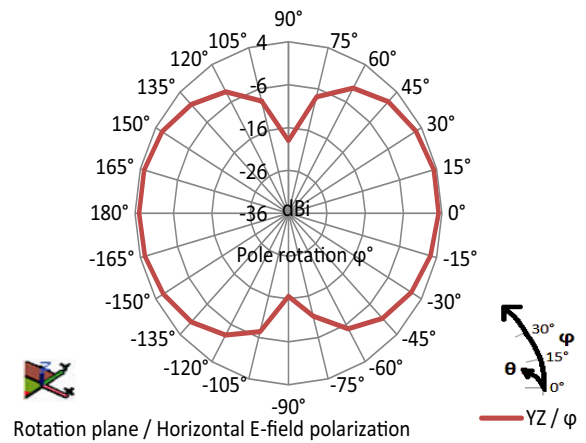

Fig. 5 - VJ5601M868MXBSR YZ Radiation Pattern

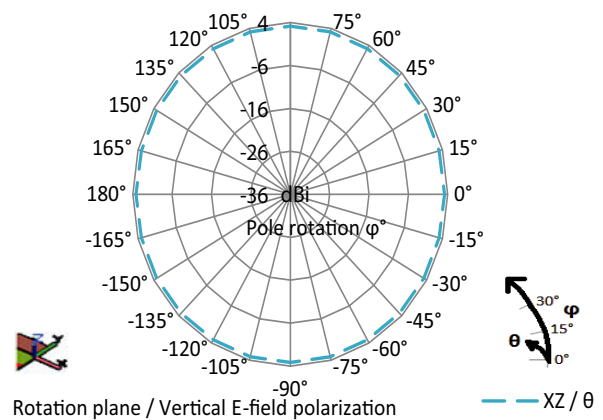

Fig. 6 - VJ5601M868MXBSR XZ Radiation Pattern

FOOTPRINT, MECHANICAL AND PCB DIMENSIONS

The antenna footprint and mechanical dimensions are presented in Figure 7. Optimal tuning is adjusted according to PCB layout.

For additional mechanical support, it is recommended to add one drop of heat curing epoxy glue.

- The glue dot should not overlap with any of the soldering pads
- Apply the glue dot at the center of the antenna.
- The glue dot area secures the chip firmly to the PCB

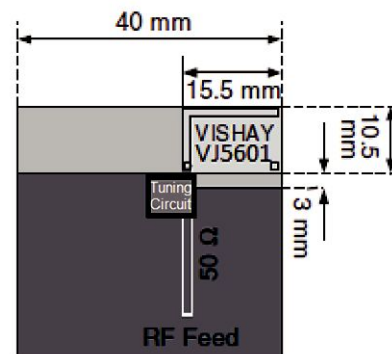
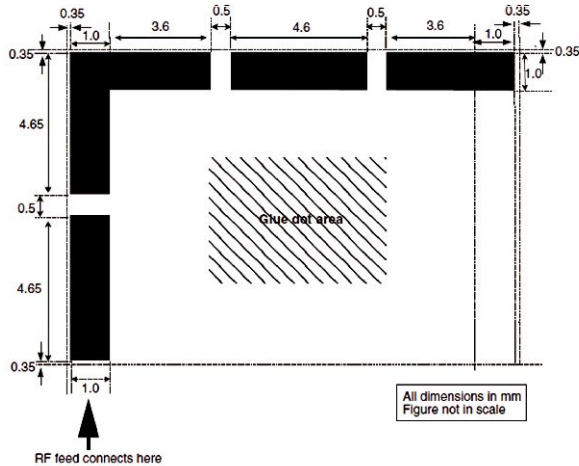

DIMENSIONS	(mm)
Length	15.5 +/- 0.5
Width	10.5 +/- 0.5
Height	1.2 +/- 0.1

Legend:

- Required ground plane on top, bottom layers
- Copper and component free area on all layers

Fig. 7 - Footprint, Chip Antenna Mechanical Dimensions, and PCB Layout Dimensions of VJ5601M868

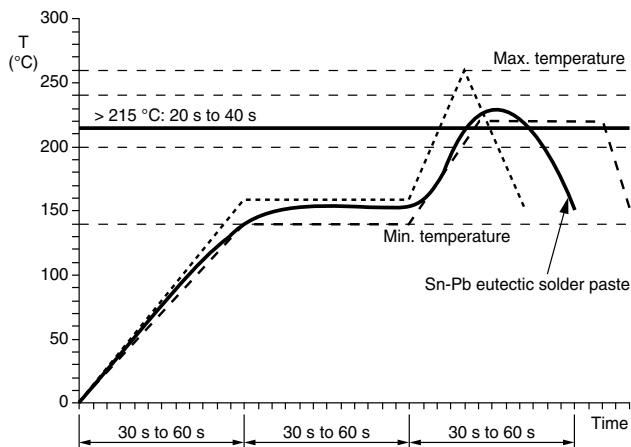

Fig. 8 - Soldering IR Reflow with SnPb Solder

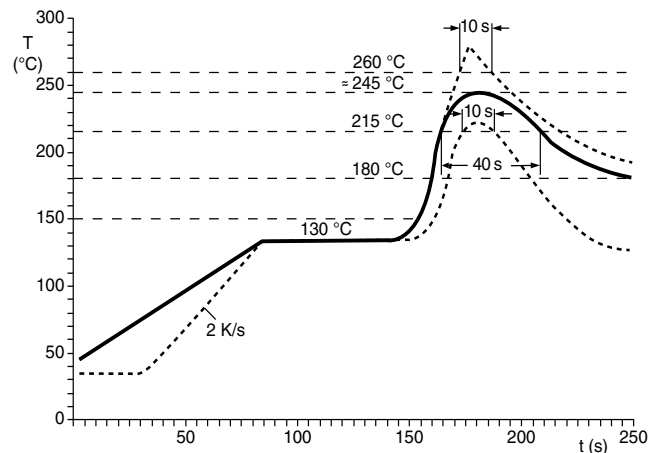

Fig. 9 - Soldering Reflow with Sn Solder

VJ5601M868 ASSEMBLY GUIDELINES

1. Mounting of antennas on a printed circuit board should be done by reflow soldering using the profiles shown (Figures 8, 9, and 10)
2. In order to provide the adequate strength between the antenna and the PCB apply a dot of heat cured epoxy glue in the center of the footprint of the antenna prior to soldering the antenna to the board. An example for such glue is Heraeus PD 860002 SA. The weight of the dot should be 5 mg to 10 mg.

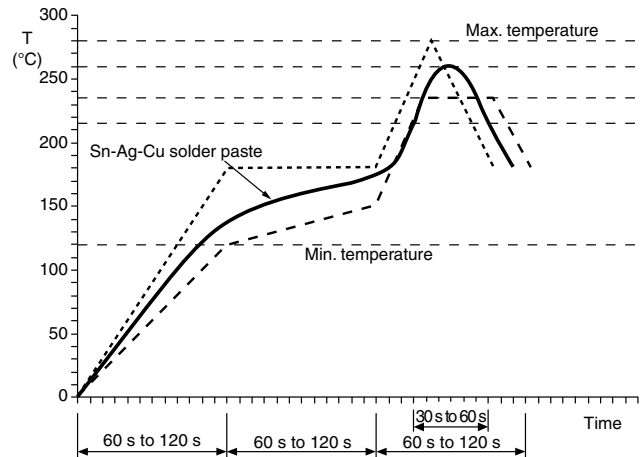

Fig. 10 - Soldering IR Reflow with SnAgCu Solder

ORDERING INFORMATION	VISHAY MATERIAL	PACKAGING QUANTITY
VJ5601M868 Chip Antenna	VJ5601M868MXBSR	1000 pieces
VJ5601M868 Evaluation Kit ⁽¹⁾	VJ5601M868MXBEK	1 kit

Note

⁽¹⁾ The VJ5601M868 kit is available for evaluation. For samples, please contact mlcc-samples@vishay.com.



Disclaimer

ALL PRODUCT, PRODUCT SPECIFICATIONS AND DATA ARE SUBJECT TO CHANGE WITHOUT NOTICE TO IMPROVE RELIABILITY, FUNCTION OR DESIGN OR OTHERWISE.

Vishay Intertechnology, Inc., its affiliates, agents, and employees, and all persons acting on its or their behalf (collectively, "Vishay"), disclaim any and all liability for any errors, inaccuracies or incompleteness contained in any datasheet or in any other disclosure relating to any product.

Vishay makes no warranty, representation or guarantee regarding the suitability of the products for any particular purpose or the continuing production of any product. To the maximum extent permitted by applicable law, Vishay disclaims (i) any and all liability arising out of the application or use of any product, (ii) any and all liability, including without limitation special, consequential or incidental damages, and (iii) any and all implied warranties, including warranties of fitness for particular purpose, non-infringement and merchantability.

Statements regarding the suitability of products for certain types of applications are based on Vishay's knowledge of typical requirements that are often placed on Vishay products in generic applications. Such statements are not binding statements about the suitability of products for a particular application. It is the customer's responsibility to validate that a particular product with the properties described in the product specification is suitable for use in a particular application. Parameters provided in datasheets and/or specifications may vary in different applications and performance may vary over time. All operating parameters, including typical parameters, must be validated for each customer application by the customer's technical experts. Product specifications do not expand or otherwise modify Vishay's terms and conditions of purchase, including but not limited to the warranty expressed therein.

Except as expressly indicated in writing, Vishay products are not designed for use in medical, life-saving, or life-sustaining applications or for any other application in which the failure of the Vishay product could result in personal injury or death. Customers using or selling Vishay products not expressly indicated for use in such applications do so at their own risk and agree to fully indemnify and hold Vishay and its distributors harmless from and against any and all claims, liabilities, expenses and damages arising or resulting in connection with such use or sale, including attorneys fees, even if such claim alleges that Vishay or its distributor was negligent regarding the design or manufacture of the part. Please contact authorized Vishay personnel to obtain written terms and conditions regarding products designed for such applications.

No license, express or implied, by estoppel or otherwise, to any intellectual property rights is granted by this document or by any conduct of Vishay. Product names and markings noted herein may be trademarks of their respective owners.

Material Category Policy

Vishay Intertechnology, Inc. hereby certifies that all its products that are identified as RoHS-Compliant fulfill the definitions and restrictions defined under Directive 2011/65/EU of The European Parliament and of the Council of June 8, 2011 on the restriction of the use of certain hazardous substances in electrical and electronic equipment (EEE) - recast, unless otherwise specified as non-compliant.

Please note that some Vishay documentation may still make reference to RoHS Directive 2002/95/EC. We confirm that all the products identified as being compliant to Directive 2002/95/EC conform to Directive 2011/65/EU.