

GENERAL DESCRIPTION

The SP6260 family is a series of CMOS positive low noise voltage regulators capable of delivering up to 200mA of continuous current.

Each of these devices consists of a voltage reference, an error amplifier, a resistor network for setting the output voltage, a current limit circuit for current protection and a chip enable circuit.

The SP6260 series feature high ripple rejection, low dropout voltage, low noise, high output voltage accuracy and low current consumption which make them ideal for use in various battery-powered and hand-held devices.

The SP6260 series is offered in the following fixed output voltage options: 1.2V, 1.5V, 1.8V, 2.5V, 2.8V, 3.0V, 3.2V and 3.3V.

The SP6260 family is available in standard lead free, RoHS compliant 5-pin SOT-23 package.

APPLICATIONS

- **Hand Held Equipments**
- **Wireless Communication Devices**
- **Battery Powered Equipments**
- **Industrial and Medical Equipments**

FEATURES

- **200mA Continuous Output Current**
 - 150mV Dropout Voltage @ $I_{OUT}=100mA$ (Except 1.2V and 1.5V Version)
 - 1.2V to 3.3V Fixed Output Voltages
 - $\pm 2\%$ Output Voltage Accuracy
- **2V Minimum Input Voltage**
- **30 μ Vrms Output Noise (10Hz-100KHz)**
- **70dB Power Supply Rejection Ratio**
- **4mV Line Regulation (typ)**
- **12mV Load Regulation (typ)**
- **Low Standby Current: 0.1 μ A Typical**
- **Low Quiescent Current: 25 μ A Typical**
- **Lead Free, RoHS Compliant 5-pin SOT-23 Package**

TYPICAL APPLICATION DIAGRAM

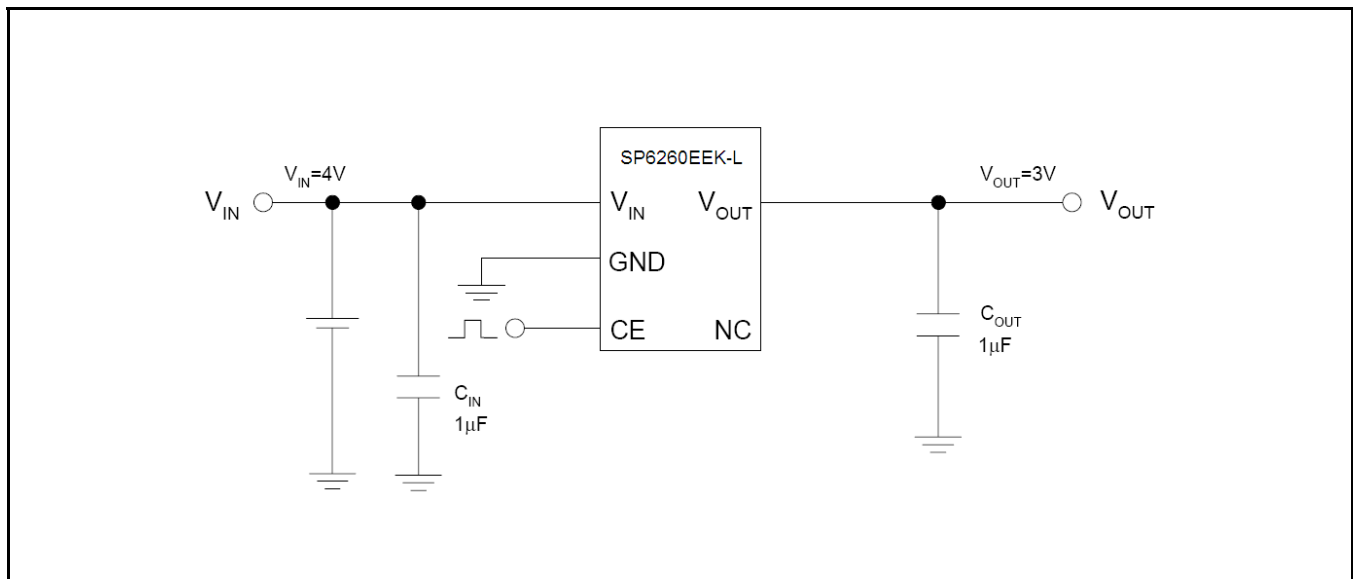

Fig. 1: SP6260 Application Diagram



ABSOLUTE MAXIMUM RATINGS

These are stress ratings only and functional operation of the device at these ratings or any other above those indicated in the operation sections of the specifications below is not implied. Exposure to absolute maximum rating conditions for extended periods of time may affect reliability.

Input Voltage V_{IN} 6.5V
 Enable Pin Input Voltage -0.3 to $V_{IN}+0.3V$
 Output Current..... 300mA
 Junction Temperature 150°C
 Storage Temperature Range -65°C to 150°C
 Lead Soldering (Sold. 10sec) 260°C
 ESD Rating (HBM - Human Body Model) 2kV
 ESD Rating (MM - Machine Model) 200V

OPERATING RATINGS

Input Voltage Range V_{IN}2.0 to 6.0V
 Junction Temperature Range T_J -40°C to 85°C
 Thermal Resistance θ_{JA} 250°C/W
 Thermal Resistance θ_{JC} 74°C/W

ELECTRICAL SPECIFICATIONS

Specifications with standard type are for an Operating Junction Temperature of $T_J = 25^\circ C$ only; limits applying over the full Operating Junction Temperature range of -40°C to 85°C are denoted by a “•”. Minimum and Maximum limits are guaranteed through test, design, or statistical correlation. Typical values represent the most likely parametric norm at $T_J = 25^\circ C$, and are provided for reference purposes only.

SP6260HEK (1.2V)

Unless otherwise indicated, $V_{IN} = 2.2V$, $C_{IN} = 1\mu F$, $C_{OUT} = 1\mu F$.

Parameter	Min.	Typ.	Max.	Units	Conditions
Output Voltage V_{OUT}	1.176	1.2	1.224	V	$V_{IN}=2.2V$ $1mA \leq I_{OUT} \leq 30mA$
Input Voltage V_{IN}			6	V	
Output Current I_{OUT}	200			mA	$V_{IN}-V_{OUT}=1V$
Load Regulation V_{RLOAD}		12	40	mV	$V_{IN}=2.2V$ $1mA \leq I_{OUT} \leq 80mA$
Line Regulation V_{RLINE}		4	16	mV	$2.2V \leq V_{IN} \leq 6V$ $I_{OUT}=30mA$
Dropout Voltage V_{DROP}		700	900	mV	$I_{OUT}=10mA$
		700	900		$I_{OUT}=100mA$
		700	900		$I_{OUT}=150mA$
		700	900		$I_{OUT}=200mA$
Quiescent Current I_Q		25	50	μA	$V_{IN}=2.2V, I_{OUT}=0mA$
Standby Current I_{STD}		0.1	1	μA	$V_{IN}=2.2V$ V_{CE} in OFF mode
Power Supply Rejection Ratio PSRR		70		dB	Ripple 0.5V _{p-p} , f=10kHz $V_{IN}=2.5V$
Output Voltage Temperature Coefficient		± 120		$\mu V/^\circ C$	• $\Delta V_{OUT}/\Delta T$
		± 100		ppm/ $^\circ C$	• $(\Delta V_{OUT}/V_{OUT})/\Delta T$
Short Current Limit I_{LIMIT}		50		mA	$V_{OUT}=0V$
RMS Output Noise V_{NOISE}		30		μV_{rms}	$T_A=25^\circ C$ $10Hz \leq f \leq 100kHz$
CE “High” Voltage	1.5			V	CE input voltage “High”
CE “Low” Voltage			0.25	V	CE input voltage “Low”
CE Pull-down Resistance R_{PD}	2.5	5	10	M Ω	



SP6260AEK (1.5V)

Unless otherwise indicated, $V_{IN} = 2.5V$, $C_{IN} = 1\mu F$, $C_{OUT} = 1\mu F$.

Parameter	Min.	Typ.	Max.	Units	Conditions
Output Voltage V_{OUT}	1.47	1.5	1.53	V	$V_{IN}=2.5V$ $1mA \leq I_{OUT} \leq 30mA$
Input Voltage V_{IN}			6	V	
Output Current I_{OUT}	200			mA	$V_{IN}-V_{OUT}=1V$
Load Regulation V_{RLOAD}		12	40	mV	$V_{IN}=2.5V$ $1mA \leq I_{OUT} \leq 80mA$
Line Regulation V_{RLINE}		4	16	mV	$2.3V \leq V_{IN} \leq 6V$ $I_{OUT}=30mA$
Dropout Voltage V_{DROP}		400	600	mV	$I_{OUT}=10mA$
		400	600		$I_{OUT}=100mA$
		400	600		$I_{OUT}=150mA$
		400	600		$I_{OUT}=200mA$
Quiescent Current I_Q		25	50	μA	$V_{IN}=2.5V, I_{OUT}=0mA$
Standby Current I_{STD}		0.1	1	μA	$V_{IN}=2.5V$ V_{CE} in OFF mode
Power Supply Rejection Ratio PSRR		70		dB	Ripple 0.5V _{p-p} , f=10kHz $V_{IN}=2.5V$
Output Voltage Temperature Coefficient		± 150		$\mu V/^\circ C$	$\bullet \Delta V_{OUT}/\Delta T$
		± 100		ppm/ $^\circ C$	$\bullet (\Delta V_{OUT}/V_{OUT})/\Delta T$
Short Current Limit I_{LIMIT}		50		mA	$V_{OUT}=0V$
RMS Output Noise V_{NOISE}		30		μV_{rms}	$T_A=25^\circ C$ $10Hz \leq f \leq 100kHz$
CE "High" Voltage	1.5			V	CE input voltage "High"
CE "Low" Voltage			0.25	V	CE input voltage "Low"
CE Pull-down Resistance R_{PD}	2.5	5	10	M Ω	

SP6260BEK (1.8V)

Unless otherwise indicated, $V_{IN} = 2.8V$, $C_{IN} = 1\mu F$, $C_{OUT} = 1\mu F$.

Parameter	Min.	Typ.	Max.	Units	Conditions
Output Voltage V_{OUT}	1.764	1.8	1.836	V	$V_{IN}=2.8V$ $1mA \leq I_{OUT} \leq 30mA$
Input Voltage V_{IN}			6	V	
Output Current I_{OUT}	200			mA	$V_{IN}-V_{OUT}=1V$
Load Regulation V_{RLOAD}		12	40	mV	$V_{IN}=2.8V$ $1mA \leq I_{OUT} \leq 80mA$
Line Regulation V_{RLINE}		4	16	mV	$2.3V \leq V_{IN} \leq 6V$ $I_{OUT}=30mA$
Dropout Voltage V_{DROP}		20	40	mV	$I_{OUT}=10mA$
		150	300		$I_{OUT}=100mA$
		200	400		$I_{OUT}=150mA$
		250	500		$I_{OUT}=200mA$
Quiescent Current I_Q		25	50	μA	$V_{IN}=2.8V, I_{OUT}=0mA$
Standby Current I_{STD}		0.1	1	μA	$V_{IN}=2.8V$ V_{CE} in OFF mode
Power Supply Rejection Ratio PSRR		70		dB	Ripple 0.5V _{p-p} , f=10kHz $V_{IN}=2.5V$
Output Voltage Temperature Coefficient		± 180		$\mu V/^\circ C$	$\bullet \Delta V_{OUT}/\Delta T$
		± 100		ppm/ $^\circ C$	$\bullet (\Delta V_{OUT}/V_{OUT})/\Delta T$



200mA RF Low Noise LDO Regulator

Short Current Limit I_{LIMIT}		50		mA	$V_{OUT}=0V$
RMS Output Noise V_{NOISE}		30		μV_{rms}	$T_A=25^{\circ}C$ $10Hz \leq f \leq 100kHz$
CE "High" Voltage	1.5			V	CE input voltage "High"
CE "Low" Voltage			0.25	V	CE input voltage "Low"
CE Pull-down Resistance R_{PD}	2.5	5	10	$M\Omega$	

SP6260CEK (2.5V)

Unless otherwise indicated, $V_{IN} = 3.5V$, $C_{IN} = 1\mu F$, $C_{OUT} = 1\mu F$.

Parameter	Min.	Typ.	Max.	Units	Conditions
Output Voltage V_{OUT}	2.45	2.5	2.55	V	$V_{IN}=3.5V$ $1mA \leq I_{OUT} \leq 30mA$
Input Voltage V_{IN}			6	V	
Output Current I_{OUT}	200			mA	$V_{IN}-V_{OUT}=1V$
Load Regulation V_{RLOAD}		12	40	mV	$V_{IN}=3.5V$ $1mA \leq I_{OUT} \leq 80mA$
Line Regulation V_{RLINE}		4	16	mV	$3.0V \leq V_{IN} \leq 6V$ $I_{OUT}=30mA$
Dropout Voltage V_{DROP}		20	40	mV	$I_{OUT}=10mA$
		150	300		$I_{OUT}=100mA$
		200	400		$I_{OUT}=150mA$
		250	500		$I_{OUT}=200mA$
Quiescent Current I_Q		25	50	μA	$V_{IN}=3.5V, I_{OUT}=0mA$
Standby Current I_{STD}		0.1	1	μA	$V_{IN}=3.5V$ V_{CE} in OFF mode
Power Supply Rejection Ratio PSRR		70		dB	Ripple 0.5V _{p-p} , $f=10kHz$ $V_{IN}=2.5V$
Output Voltage Temperature Coefficient		± 250		$\mu V/^{\circ}C$	$\Delta V_{OUT}/\Delta T$
		± 100		ppm/ $^{\circ}C$	$(\Delta V_{OUT}/V_{OUT})/\Delta T$
Short Current Limit I_{LIMIT}		50		mA	$V_{OUT}=0V$
RMS Output Noise V_{NOISE}		30		μV_{rms}	$T_A=25^{\circ}C$ $10Hz \leq f \leq 100kHz$
CE "High" Voltage	1.5			V	CE input voltage "High"
CE "Low" Voltage			0.25	V	CE input voltage "Low"
CE Pull-down Resistance R_{PD}	2.5	5	10	$M\Omega$	

SP6260DEK (2.8V)

Unless otherwise indicated, $V_{IN} = 3.8V$, $C_{IN} = 1\mu F$, $C_{OUT} = 1\mu F$.

Parameter	Min.	Typ.	Max.	Units	Conditions
Output Voltage V_{OUT}	2.744	2.8	2.856	V	$V_{IN}=3.8V$ $1mA \leq I_{OUT} \leq 30mA$
Input Voltage V_{IN}			6	V	
Output Current I_{OUT}	200			mA	$V_{IN}-V_{OUT}=1V$
Load Regulation V_{RLOAD}		12	40	mV	$V_{IN}=3.8V$ $1mA \leq I_{OUT} \leq 80mA$
Line Regulation V_{RLINE}		4	16	mV	$3.3V \leq V_{IN} \leq 6V$ $I_{OUT}=30mA$
Dropout Voltage V_{DROP}		20	40	mV	$I_{OUT}=10mA$
		150	300		$I_{OUT}=100mA$
		200	400		$I_{OUT}=150mA$
		250	500		$I_{OUT}=200mA$



Quiescent Current I_Q		25	50	μA	$V_{IN}=3.8\text{V}, I_{OUT}=0\text{mA}$
Standby Current I_{STD}		0.1	1	μA	$V_{IN}=3.8\text{V}$ V_{CE} in OFF mode
Power Supply Rejection Ratio PSRR		70		dB	Ripple 0.5V _{p-p} , f=10kHz $V_{IN}=2.5\text{V}$
Output Voltage Temperature Coefficient		± 280		$\mu\text{V}/^\circ\text{C}$	• $\Delta V_{OUT}/\Delta T$
		± 100		ppm/ $^\circ\text{C}$	• $(\Delta V_{OUT}/V_{OUT})/\Delta T$
Short Current Limit I_{LIMIT}		50		mA	$V_{OUT}=0\text{V}$
RMS Output Noise V_{NOISE}		30		μV_{rms}	$T_A=25^\circ\text{C}$ $10\text{Hz} \leq f \leq 100\text{kHz}$
CE "High" Voltage	1.5			V	CE input voltage "High"
CE "Low" Voltage			0.25	V	CE input voltage "Low"
CE Pull-down Resistance R_{PD}	2.5	5	10	M Ω	

SP6260EEK (3.0V)

Unless otherwise indicated, $V_{IN} = 4.0\text{V}$, $C_{IN} = 1\mu\text{F}$, $C_{OUT} = 1\mu\text{F}$.

Parameter	Min.	Typ.	Max.	Units	Conditions
Output Voltage V_{OUT}	2.940	3.0	3.060	V	$V_{IN}=4.0\text{V}$ $1\text{mA} \leq I_{OUT} \leq 30\text{mA}$
Input Voltage V_{IN}			6	V	
Output Current I_{OUT}	200			mA	$V_{IN}-V_{OUT}=1\text{V}$
Load Regulation V_{RLOAD}		12	40	mV	$V_{IN}=4.0\text{V}$ $1\text{mA} \leq I_{OUT} \leq 80\text{mA}$
Line Regulation V_{RLINE}		4	16	mV	$3.5\text{V} \leq V_{IN} \leq 6\text{V}$ $I_{OUT}=30\text{mA}$
Dropout Voltage V_{DROP}		20	40	mV	$I_{OUT}=10\text{mA}$
		150	300		$I_{OUT}=100\text{mA}$
		200	400		$I_{OUT}=150\text{mA}$
		250	500		$I_{OUT}=200\text{mA}$
Quiescent Current I_Q		25	50	μA	$V_{IN}=4.0\text{V}, I_{OUT}=0\text{mA}$
Standby Current I_{STD}		0.1	1	μA	$V_{IN}=4.0\text{V}$ V_{CE} in OFF mode
Power Supply Rejection Ratio PSRR		70		dB	Ripple 0.5V _{p-p} , f=10kHz $V_{IN}=2.5\text{V}$
Output Voltage Temperature Coefficient		± 300		$\mu\text{V}/^\circ\text{C}$	• $\Delta V_{OUT}/\Delta T$
		± 100		ppm/ $^\circ\text{C}$	• $(\Delta V_{OUT}/V_{OUT})/\Delta T$
Short Current Limit I_{LIMIT}		50		mA	$V_{OUT}=0\text{V}$
RMS Output Noise V_{NOISE}		30		μV_{rms}	$T_A=25^\circ\text{C}$ $10\text{Hz} \leq f \leq 100\text{kHz}$
CE "High" Voltage	1.5			V	CE input voltage "High"
CE "Low" Voltage			0.25	V	CE input voltage "Low"
CE Pull-down Resistance R_{PD}	2.5	5	10	M Ω	

SP6260FEK (3.2V)

Unless otherwise indicated, $V_{IN} = 4.2\text{V}$, $C_{IN} = 1\mu\text{F}$, $C_{OUT} = 1\mu\text{F}$.

Parameter	Min.	Typ.	Max.	Units	Conditions
Output Voltage V_{OUT}	3.136	3.2	3.264	V	$V_{IN}=4.2\text{V}$ $1\text{mA} \leq I_{OUT} \leq 30\text{mA}$
Input Voltage V_{IN}			6	V	
Output Current I_{OUT}	200			mA	$V_{IN}-V_{OUT}=1\text{V}$



200mA RF Low Noise LDO Regulator

Load Regulation V_{RLOAD}		12	40	mV	$V_{IN}=4.2V$ $1mA \leq I_{OUT} \leq 80mA$
Line Regulation V_{RLINE}		4	16	mV	$3.7V \leq V_{IN} \leq 6V$ $I_{OUT}=30mA$
Dropout Voltage V_{DROP}		20	40	mV	$I_{OUT}=10mA$
		150	300		$I_{OUT}=100mA$
		200	400		$I_{OUT}=150mA$
		250	500		$I_{OUT}=200mA$
Quiescent Current I_Q		25	50	μA	$V_{IN}=4.2V, I_{OUT}=0mA$
Standby Current I_{STD}		0.1	1	μA	$V_{IN}=4.2V$ V_{CE} in OFF mode
Power Supply Rejection Ratio PSRR		70		dB	Ripple 0.5V _{p-p} , f=10kHz $V_{IN}=2.5V$
Output Voltage Temperature Coefficient		± 320		$\mu V/^\circ C$	• $\Delta V_{OUT}/\Delta T$
		± 100		ppm/ $^\circ C$	• $(\Delta V_{OUT}/V_{OUT})/\Delta T$
Short Current Limit I_{LIMIT}		50		mA	$V_{OUT}=0V$
RMS Output Noise V_{NOISE}		30		μV_{rms}	$T_A=25^\circ C$ $10Hz \leq f \leq 100kHz$
CE "High" Voltage	1.5			V	CE input voltage "High"
CE "Low" Voltage			0.25	V	CE input voltage "Low"
CE Pull-down Resistance R_{PD}	2.5	5	10	M Ω	

SP6260GEK (3.3V)

Unless otherwise indicated, $V_{IN} = 4.3V$, $C_{IN} = 1\mu F$, $C_{OUT} = 1\mu F$.

Parameter	Min.	Typ.	Max.	Units	Conditions
Output Voltage V_{OUT}	3.234	3.3	3.366	V	$V_{IN}=4.3V$ $1mA \leq I_{OUT} \leq 30mA$
Input Voltage V_{IN}			6	V	
Output Current I_{OUT}	200			mA	$V_{IN}-V_{OUT}=1V$
Load Regulation V_{RLOAD}		12	40	mV	$V_{IN}=4.3V$ $1mA \leq I_{OUT} \leq 80mA$
Line Regulation V_{RLINE}		4	16	mV	$3.8V \leq V_{IN} \leq 6V$ $I_{OUT}=30mA$
Dropout Voltage V_{DROP}		20	40	mV	$I_{OUT}=10mA$
		150	300		$I_{OUT}=100mA$
		200	400		$I_{OUT}=150mA$
		250	500		$I_{OUT}=200mA$
Quiescent Current I_Q		25	50	μA	$V_{IN}=4.3V, I_{OUT}=0mA$
Standby Current I_{STD}		0.1	1	μA	$V_{IN}=4.3V$ V_{CE} in OFF mode
Power Supply Rejection Ratio PSRR		70		dB	Ripple 0.5V _{p-p} , f=10kHz $V_{IN}=2.5V$
Output Voltage Temperature Coefficient		± 330		$\mu V/^\circ C$	• $\Delta V_{OUT}/\Delta T$
		± 100		ppm/ $^\circ C$	• $(\Delta V_{OUT}/V_{OUT})/\Delta T$
Short Current Limit I_{LIMIT}		50		mA	$V_{OUT}=0V$
RMS Output Noise V_{NOISE}		30		μV_{rms}	$T_A=25^\circ C$ $10Hz \leq f \leq 100kHz$
CE "High" Voltage	1.5			V	CE input voltage "High"
CE "Low" Voltage			0.25	V	CE input voltage "Low"
CE Pull-down Resistance R_{PD}	2.5	5	10	M Ω	

BLOCK DIAGRAM

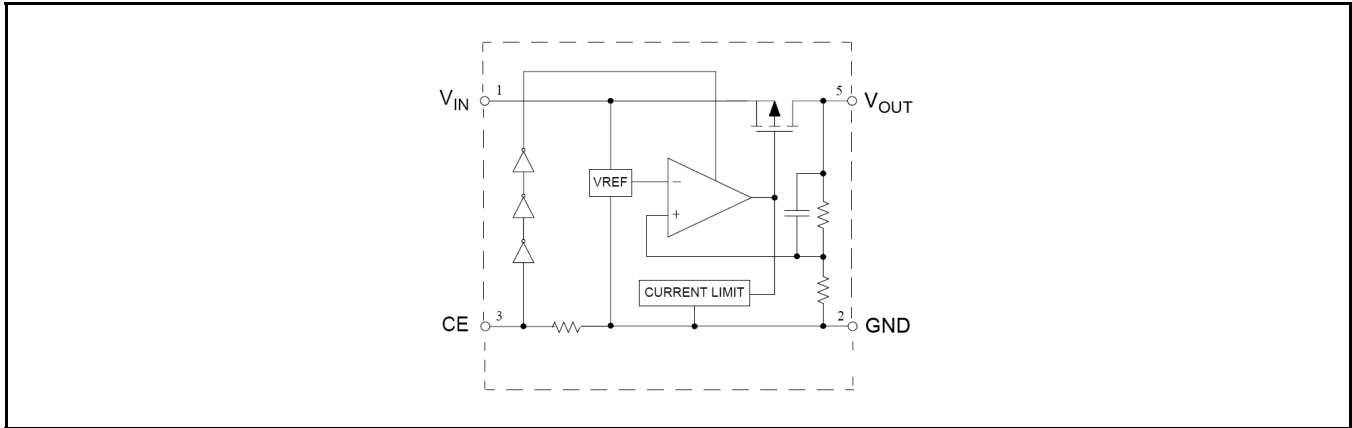

Fig. 2: SP6260 Block Diagram

PIN ASSIGNMENT

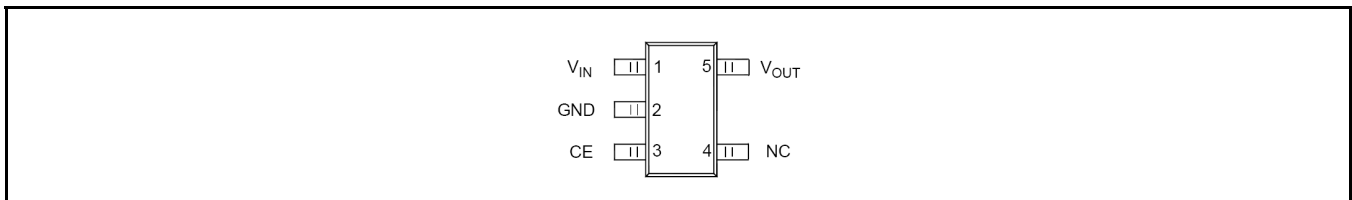

Fig. 3: SP6260 Pin Assignment

PIN DESCRIPTION

Name	Pin Number	Description
V_{IN}	1	Input voltage
GND	2	Ground
CE	3	Enable input pin. high=enable low=shutdown
NC	4	No connection
V_{OUT}	5	Regulated output voltage

ORDERING INFORMATION

Part Number	Junction Temperature Range	Marking	Package	Packing Quantity	Note 1	Note 2
SP6260HEK-L/TR	-40°C to +85°C	CCWW	SOT-23-5	3K/Tape & Reel	Lead Free	1.2V version
SP6260AEK-L/TR	-40°C to +85°C	DBWW	SOT-23-5	3K/Tape & Reel	Lead Free	1.5V version
SP6260BEK-L/TR	-40°C to +85°C	EBWW	SOT-23-5	3K/Tape & Reel	Lead Free	1.8V version
SP6260CEK-L/TR	-40°C to +85°C	FBWW	SOT-23-5	3K/Tape & Reel	Lead Free	2.5V version
SP6260DEK-L/TR	-40°C to +85°C	GBWW	SOT-23-5	3K/Tape & Reel	Lead Free	2.8V version
SP6260EEK-L/TR	-40°C to +85°C	HBWW	SOT-23-5	3K/Tape & Reel	Lead Free	3.0V version
SP6260FEK-L/TR	-40°C to +85°C	JBWW	SOT-23-5	3K/Tape & Reel	Lead Free	3.2V version
SP6260GEK-L/TR	-40°C to +85°C	KBWW	SOT-23-5	3K/Tape & Reel	Lead Free	3.3V version

"WW" = Work Week

TYPICAL PERFORMANCE CHARACTERISTICS

All data taken at $V_{IN} = 2.7V$ to $5.5V$, $T_J = T_A = 25^\circ C$, unless otherwise specified - Schematic and BOM from Application Information section of this datasheet.

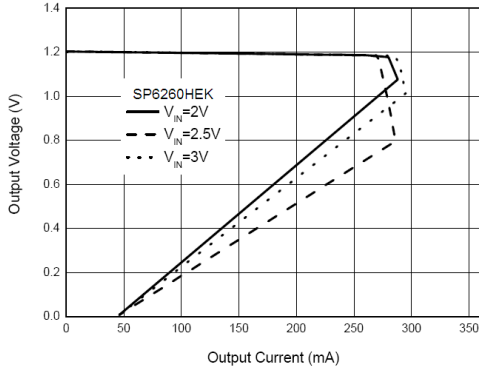

Fig. 4: Output Voltage vs. Output Current SP6260HEK (1.2V)

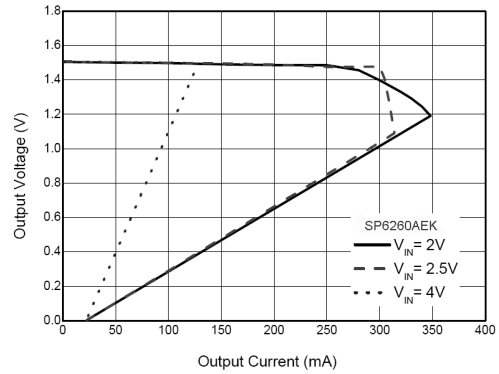

Fig. 5: Output Voltage vs. Output Current SP6260AEK (1.5V)

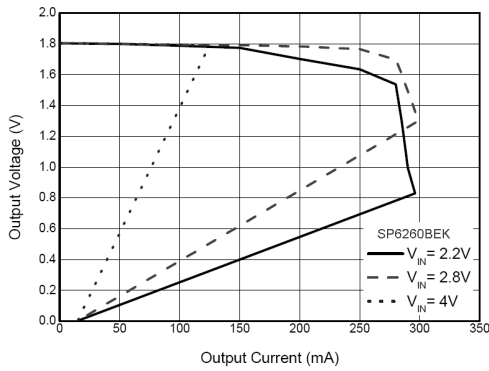

Fig. 6: Output Voltage vs. Output Current SP6260BEK (1.8V)

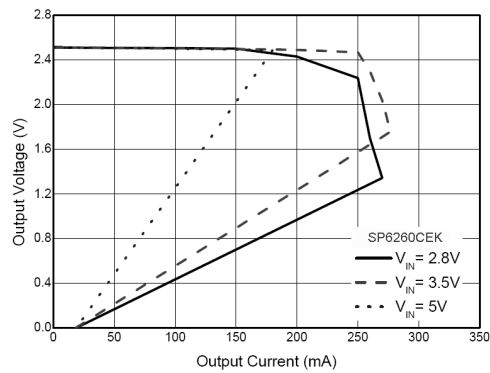

Fig. 7: Output Voltage vs. Output Current SP6260CEK (2.5V)

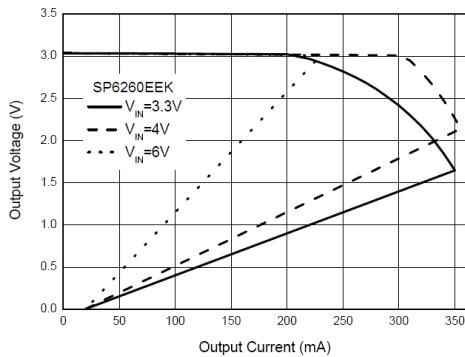

Fig. 8: Output Voltage vs. Output Current SP6260EEK (3.0V)

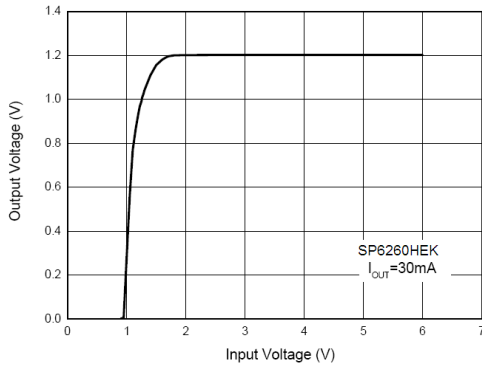

Fig. 9: Output Voltage vs. Input Voltage
SP6260HEK (1.2V)

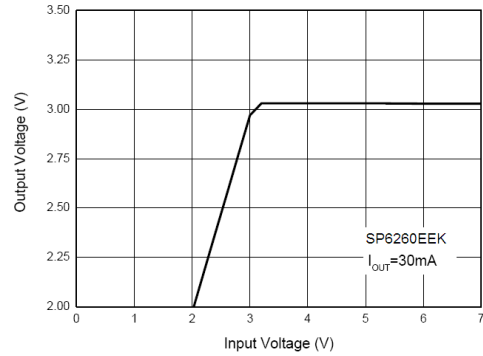

Fig. 10: Output Voltage vs. Input Voltage
SP6260EEK (3.0V)

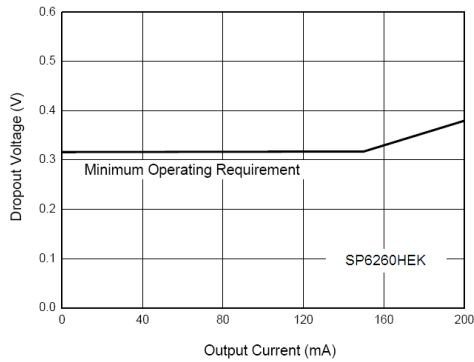

Fig. 11: Dropout Voltage vs. Output Current
SP6260HEK-L (1.2V)

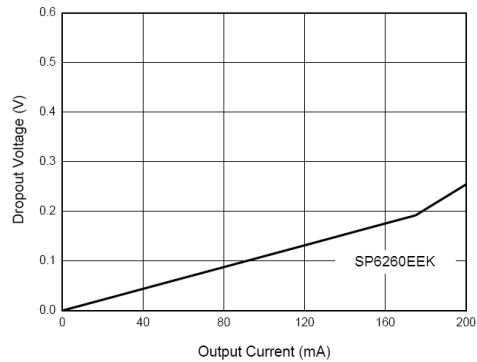

Fig. 12: Dropout Voltage vs. Output Current
SP6260EEK-L (3.0V)

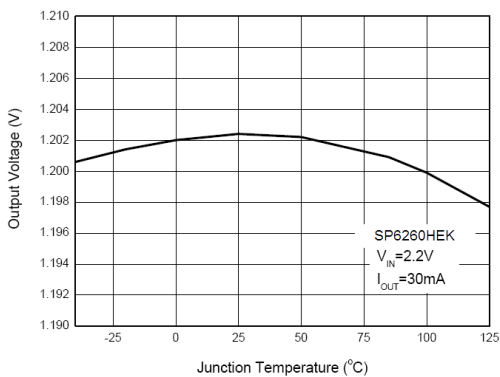

Fig. 13: Output Voltage vs. Junction Temperature
SP6260HEK-L (1.2V)

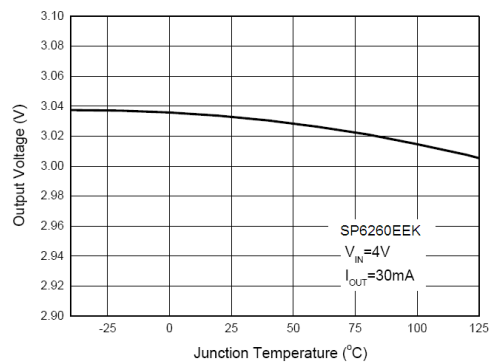

Fig. 14: Output Voltage vs. Junction Temperature
SP6260EEK-L (3.0V)

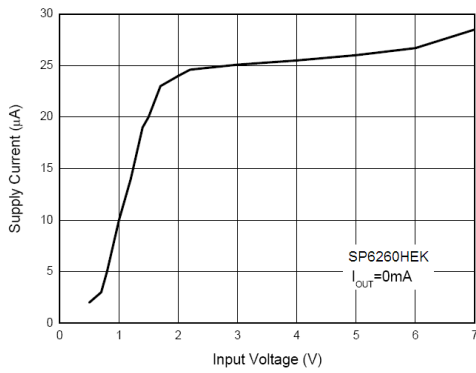

Fig. 15: Supply Current vs. Input Voltage SP6260HEK (1.2V)

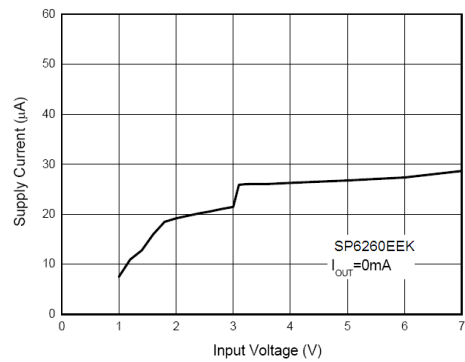

Fig. 16: Supply Current vs. Input Voltage SP6260EEK (3.0V)

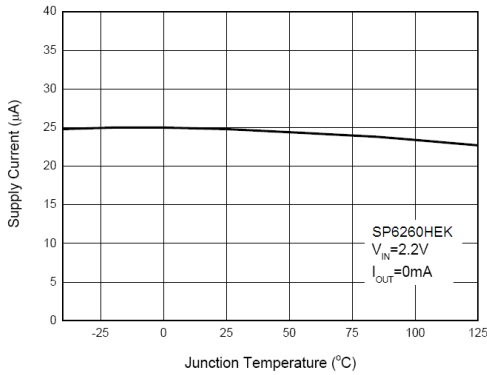

Fig. 17: Supply Current vs. Junction Temperature SP6260HEK (1.2V)

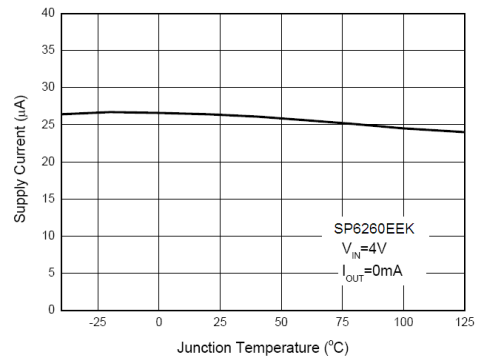

Fig. 18: Supply Current vs. Junction Temperature SP6260EEK (3.0V)

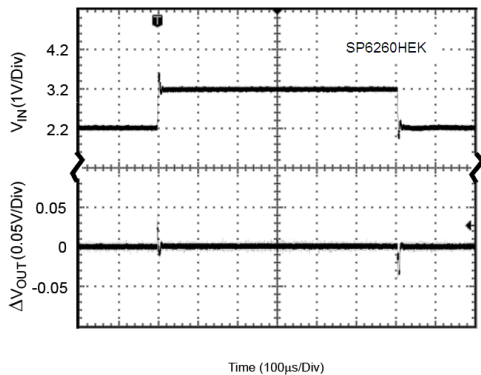

Fig. 19: Line Transient SP6260HEK (1.2V)
(Conditions: $I_{OUT}=30\text{mA}$, $C_{IN}=1\mu\text{F}$, $C_{OUT}=1\mu\text{F}$)

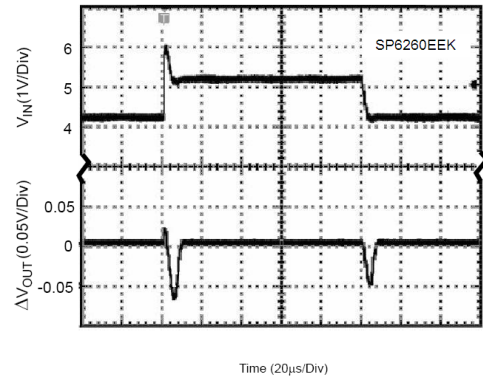

Fig. 20: Line Transient SP6260EEK (3.0V)
(Conditions: $I_{OUT}=30\text{mA}$, $C_{IN}=1\mu\text{F}$, $C_{OUT}=1\mu\text{F}$)

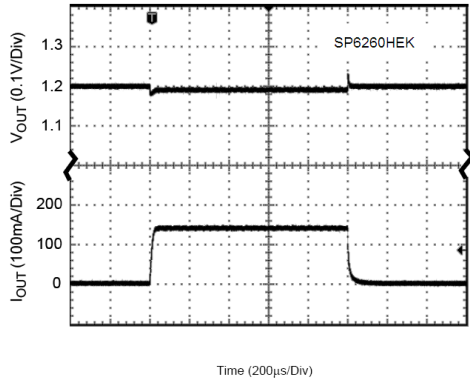

Fig. 21: Line Transient SP6260HEK (1.2V)
(Conditions: $V_{IN}=2.5V$, $C_{IN}=1\mu F$, $C_{OUT}=1\mu F$)

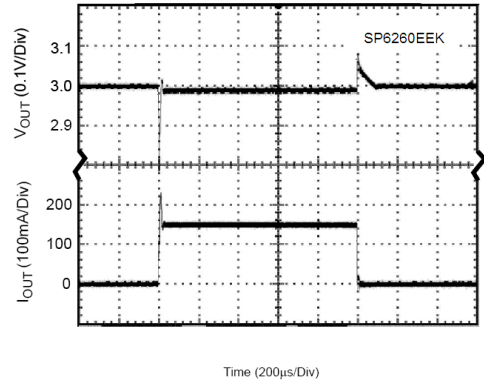

Fig. 22: Line Transient SP6260EEK (3.0V)
(Conditions: $V_{IN}=4V$, $C_{IN}=1\mu F$, $C_{OUT}=1\mu F$)

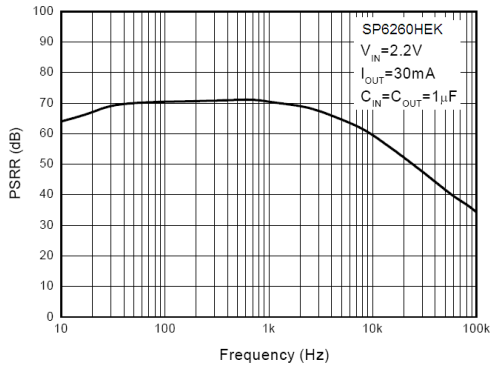

Fig. 23: PSRR vs. Frequency
SP6260HEK (1.2V)

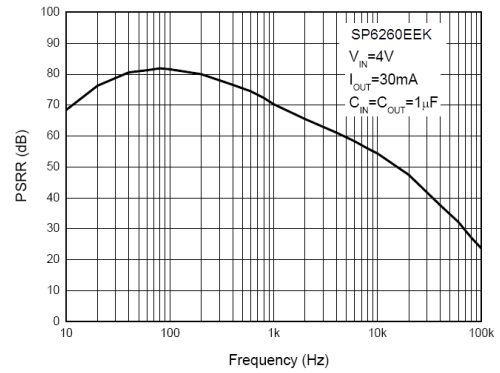
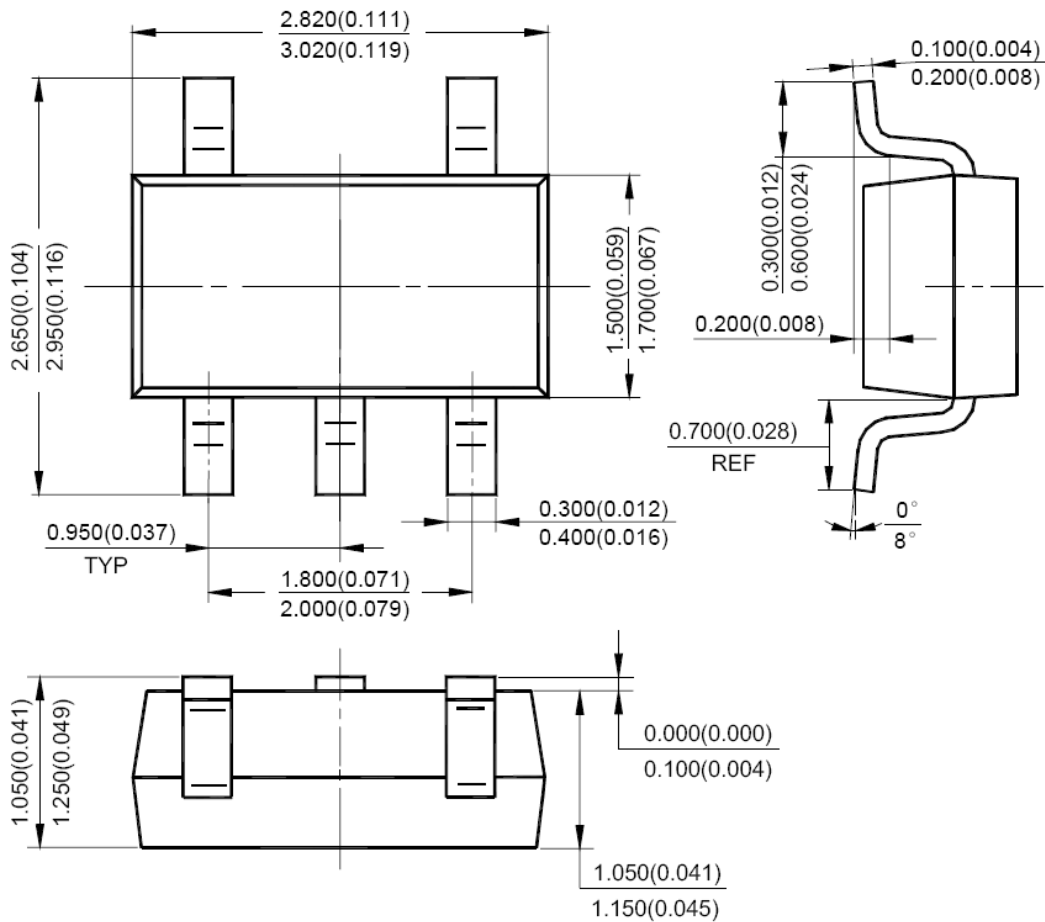

Fig. 21: PSRR vs. Frequency
SP6260EEK (3.0V)

PACKAGE SPECIFICATION

5-PIN SOT-23

Unit: mm (inch)





REVISION HISTORY

Revision	Date	Description
0.1		Initial Data Sheet
2.0.0	10/27/2010	Reformat of datasheet Increased output current capabilities to 200mA Removal of 1.5V version curves Addition of the 1.2V version data and curves
2.1.0	01/26/2011	Corrected Electrical tables V_{OUT} range for SP6260E, SP6260F and SP6260G Addition of "Output Current vs Output Voltage" curves figures 5, 6 and 7.

FOR FURTHER ASSISTANCE

Email:

customersupport@exar.com

Exar Technical Documentation:

<http://www.exar.com/TechDoc/default.aspx?>

EXAR CORPORATION

HEADQUARTERS AND SALES OFFICES

48720 Kato Road

Fremont, CA 94538 – USA

Tel.: +1 (510) 668-7000

Fax: +1 (510) 668-7030

www.exar.com



NOTICE

EXAR Corporation reserves the right to make changes to the products contained in this publication in order to improve design, performance or reliability. EXAR Corporation assumes no responsibility for the use of any circuits described herein, conveys no license under any patent or other right, and makes no representation that the circuits are free of patent infringement. Charts and schedules contained here in are only for illustration purposes and may vary depending upon a user's specific application. While the information in this publication has been carefully checked; no responsibility, however, is assumed for inaccuracies.

EXAR Corporation does not recommend the use of any of its products in life support applications where the failure or malfunction of the product can reasonably be expected to cause failure of the life support system or to significantly affect its safety or effectiveness. Products are not authorized for use in such applications unless EXAR Corporation receives, in writing, assurances to its satisfaction that: (a) the risk of injury or damage has been minimized; (b) the user assumes all such risks; (c) potential liability of EXAR Corporation is adequately protected under the circumstances.

Reproduction, in part or whole, without the prior written consent of EXAR Corporation is prohibited.