

CMOS LDO Regulator for Portable Equipments

Dual, Low-Dropout Linear Regulator



BD7003NUX, BD7004NUX

No.12020ECT09

●Descriptions

The BD7003NUX, BD7004NUX are dual channels, 300mA low-dropout voltage regulator output at each channel. The output voltage range is from 1.2V to 3.3V by operating range from 2.5V to 5.5V. The output voltages, VOUT1 and VOUT2, are determined at power up by the state of P1 and P2(see the table of "Output-Voltage Programming"). The BD7003NUX, BD7004NUX offer 1.8% accuracy and low-dropout. The shutdown current is near the zero current which is suitable for battery powered device. The BD7003NUX, BD7004NUX are mounted on VSON008X2020(2.0mmX2.0mmX0.6mm), which contributes to the space-saving design of set.

●Features

- 1) 2-channel 300mA, CMOS-type LDOs.
- 2) Pin-Programmable Output Voltage.
(9 steps adjustable VO ; See the Table of "Output-Voltage Programming".)
- 3) LDOs Power ON/OFF Enable Control.
- 4) 2.0mm × 2.0mm Package.
- 5) Small Ceramic Output Capacitors(1 μ F).
- 6) Equipped with Over Current Limiter and Thermal Shutdown Circuit(TSD) .

●Applications

Battery-powered portable equipment, etc.

●Absolute Maximum Ratings (Ta = 25°C)

Parameter	Symbol	Ratings	Unit
Maximum Supply Voltage (VIN)	VIN	-0.3 ~ 7	V
Maximum Input Voltage 1 (P1,P2,EN1,EN2)	VINMAX1	-0.3 ~ 7	V
Maximum Input Voltage 2 (Vout1,Vout2)	VINMAX2	-0.3~Vin+0.3	V
Power Dissipation	Pd	1360* ¹	mW
Operating Temperature Range	Topr	-40 ~ +85	°C
Storage Temperature Range	Tstg	-55 ~ +150	°C

*¹ This is the allowable loss of when it is mounted on a ROHM specification board 40mm × 40mm × 1.5mm
To use at temperature higher than 25°C , derate 10.9mW per 1°C

* This product is not especially designed to be protected from radioactivity.

●Recommended Operating Range (Ta=-40~+85°C)

Parameter	Symbol	Ratings	Unit
Input Power Supply Voltage Range	VIN	2.5~5.5	V

● Power Dissipation



As for power dissipation, an approximate estimate of the heat reduction characteristics and internal power consumption of IC are shown, so please use these for reference. Since power dissipation changes substantially depending on the implementation conditions (board size, board thickness, metal wiring rate, number of layers and through holes, etc.), it is recommended to measure Pd on a set board. Exceeding the power dissipation of IC may lead to deterioration of the original IC performance, such as causing operation of the thermal shutdown circuit or reduction in current capability. Therefore, be sure to prepare sufficient margin within power dissipation for usage.

Calculation of the maximum internal power consumption of IC (P_{MAX})

$$P_{MAX} = (V_{IN} - V_{OUT}) \times I_{OUT(MAX)}$$

(V_{IN}: Input voltage V_{OUT}: Output voltage I_{OUT(MAX)}: Maximum output current)

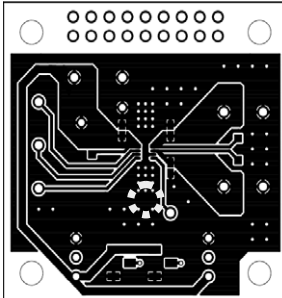
Measurement conditions

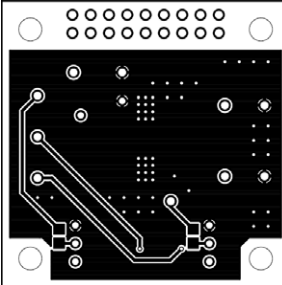
	Evaluation Board 1 (Double-side Board)
Layout of Board for Measurement (Unit: mm)	 <p>Top Layer (Top View)</p>
 IC Implementation Position	 <p>Bottom Layer (Top View)</p>
Power Dissipation	1.36W
Thermal Resistance	θ _{ja} =91.9°C/W

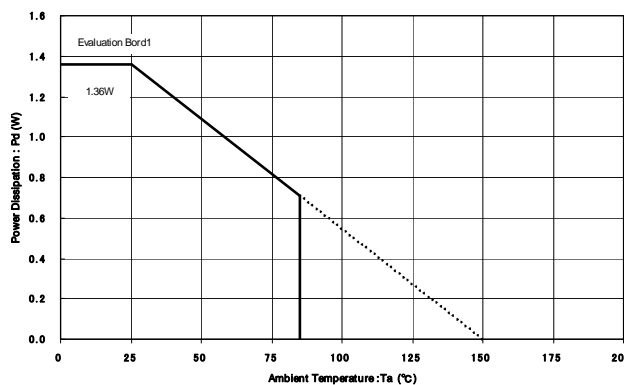

Fig.1. VSON008X2020 Power dissipation heat reduction characteristics (Reference)

* Please design the margin so that P_{MAX} becomes is than Pd (P_{MAX}<Pd) within the usage temperature range.

● **Electrical Characteristics** ($V_{in}=3.7V$, $EN1=EN2=V_{in}$, $T_a = +25^{\circ}C$, unless otherwise noted.)

Parameter	Symbol	Limits			Unit	Condition
		Min	Typ	Max		
Output Voltage range	VOUT	1.2	-	3.3	V	
Input Voltage range	VIN	2.5	-	5.5	V	
Output Voltage Accuracy	Δv_{outa}	-1.8	-	1.8	%	$I_{out}=1mA$, $V_{OUT} \geq 1.5V$
	Δv_{outb}	-30	-	+30	mV	$I_{out}=1mA$, $V_{OUT}=1.2V$
Maximum Output Current	I_{max}	300	-	-	mA	
Short Circuit Current	I_{sc}	-	150	-	mA	$V_{OUT} = 0V$
Ground Pin Current	I_q	-	55	95	μA	$I_{out}=0mA$
		-	35	65		One LDO shutdown, $I_{out}=0mA$
Dropout Voltage	Vdrop	-	120	170	mV	$V_{IN}=2.5V$, $V_{OUT}=2.6V$, $I_{out}=100mA$
		-	90	140		$V_{IN}=2.7V$, $V_{OUT}=2.8V$, $I_{out}=100mA$
		-	80	130		$V_{IN}=2.9V$, $V_{OUT}=3.0V$, $I_{out}=100mA$
		-	70	120		$V_{IN}=3.2V$, $V_{OUT}=3.3V$, $I_{out}=100mA$
		-	360	510		$V_{IN}=2.5V$, $V_{OUT}=2.6V$, $I_{out}=300mA$
		-	270	420		$V_{IN}=2.7V$, $V_{OUT}=2.8V$, $I_{out}=300mA$
		-	240	390		$V_{IN}=2.9V$, $V_{OUT}=3.0V$, $I_{out}=300mA$
		-	210	360		$V_{IN}=3.2V$, $V_{OUT}=3.3V$, $I_{out}=300mA$
Line Regulation	ΔV_{LNR}	-	0.02	0.2	%/V	$V_{IN}=V_{OUT}+1V$ to $V_{IN}=5.5V$, $I_{out}=10mA$
Load Regulation	ΔV_{LDR}	-	0.2	0.6	%	$I_{out}=1mA$ to $300mA$
Ripple Rejection	PSRR	-	66	-	dB	$f=100Hz$, $I_{out}=10mA$ @ $V_{OUT}=1.5V$
Output Noise	e_n	-	150	-	μV_{rms}	$f_{BW}=10Hz$ to $100kHz$; $I_{out}=10mA$
● EN1, EN2						
Enable Input Threshold	V_{iH}	1.2	-	-	V	Regulator enabled
	V_{iL}	-	-	0.5		Regulator shutdown
Enable Input Leakage Current	I_{en}	-	0.1	1	μA	$V_{en}=V_{IN}$, $T_a = +25^{\circ}C$
Shutdown Supply Current	I_{QSHDN}	-	0.1	1	μA	$V_{out}=0V$, $T_a = +25^{\circ}C$

*This product is not especially designed to be protected from radioactivity.

Output-Voltage Programming

PIN Name	P1	P2	BD7003NUX		BD7004NUX	
			VOUT1	VOUT2	VOUT1	VOUT2
Set up	OPEN	OPEN	1.50	2.80	1.20	1.50
	OPEN	GND	1.80	2.60	1.20	1.80
	OPEN	VIN	1.80	2.70	1.80	1.50
	GND	OPEN	1.80	2.80	1.80	1.80
	GND	GND	1.80	2.90	1.80	3.00
	GND	VIN	2.60	2.80	1.80	3.30
	VIN	OPEN	2.80	2.80	2.80	3.00
	VIN	GND	2.90	2.90	3.00	3.00
VIN	VIN	2.80	3.30	3.30	3.30	

Output Voltage Programming Input (P1, P2)

Output voltages, VOUT1 and VOUT2, are determined at power up by the state of P1 and P2 (see the table of "Output-Voltage Programming"). Subsequent changes to P1 and P2 do not change the output voltages unless the supply power is cycled, or all EN inputs are simultaneously driven low to shutdown the device.

Shutdown (EN1, EN2)

The BD7003NUX, BD7004NUX have independent shutdown control inputs, EN1 and EN2. Driving both EN1 and EN2 low will shut down the entire device, reducing supply current to $1 \mu A$ max. Connecting EN1 and EN2 to a logic-high or VIN will enable the corresponding output(s). It is prohibited to open EN1, EN2 switches.

● Typical Application Circuit

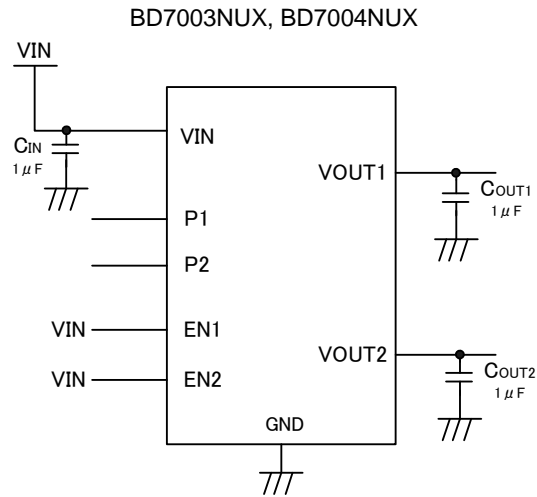
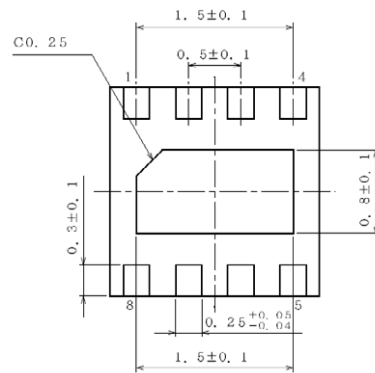
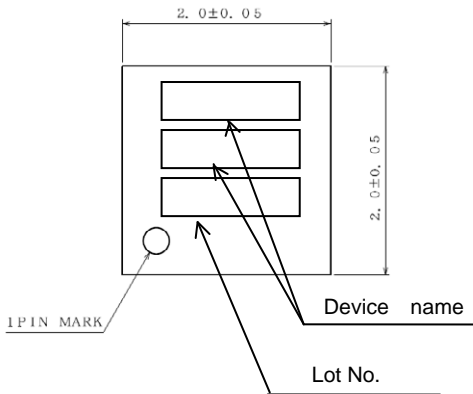

Figure2. Application Circuit

*It is prohibited to open EN1, EN2 switches.

● Package Dimensions (VSON008X2020)



[Unit: mm]

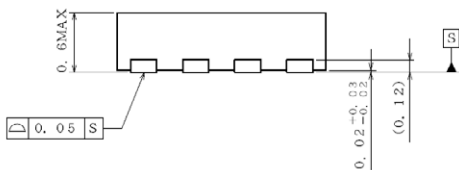

Device name	Marking
BD7003NUX	BD7003
BD7004NUX	BD7004

● Pin Descriptions

PIN description (Top View)

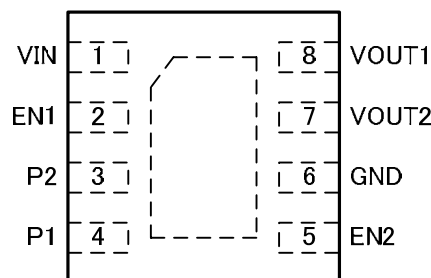

Note : Recommend connecting the Thermal Pad to the GND for excellent power dissipation.

PIN No.	Name	I/O	ESD Diode		Function
			IN	GND	
1	VIN	I	-	O	Voltage Supply
2	EN1	I	-	O	Enable Input1
3	P2	I	O	O	Control Output-Voltage PIN2
4	P1	I	O	O	Control Output-Voltage PIN1
5	EN2	I	-	O	Enable Input2
6	GND	-	O	-	GND PIN
7	VOUT2	O	-	O	LDO1 Output1
8	VOUT1	O	-	O	LDO2 Output2

●Equivalent Circuit

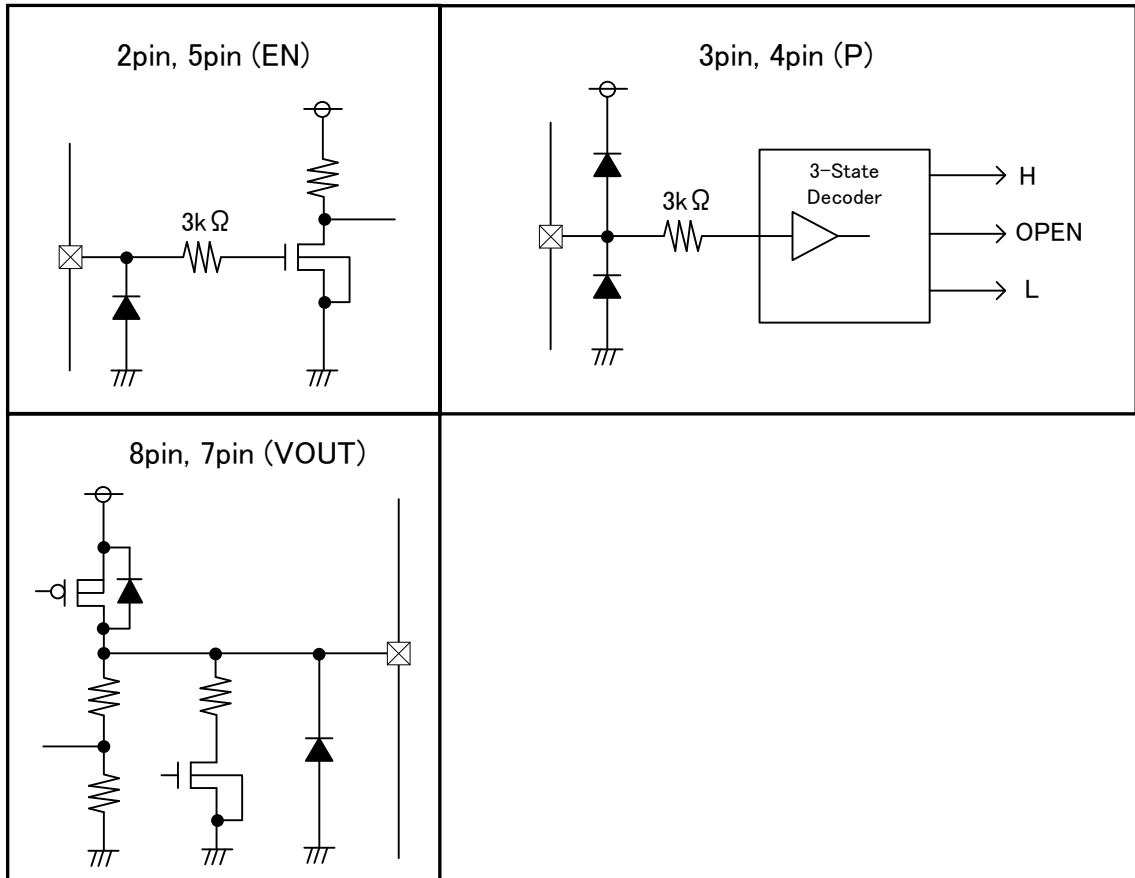

●Block Diagram

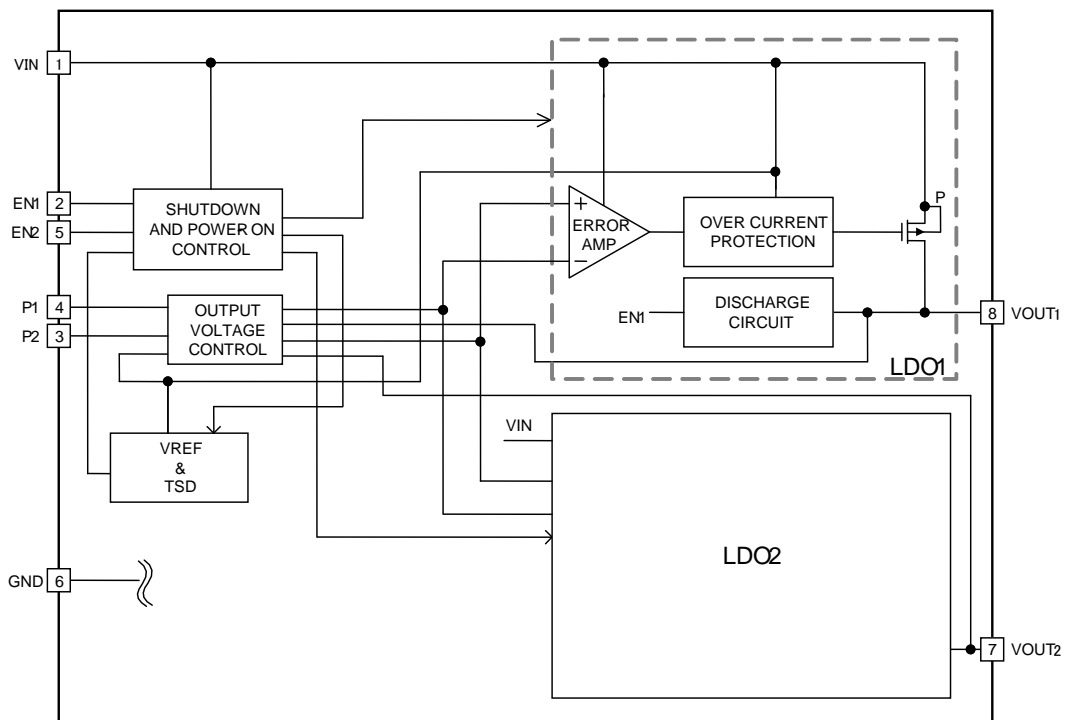

Fig.3. Block Diagram

● Typical Operating Characteristics

※The test conditions for the Typical Operating Characteristics are VIN=3.7V, CIN=1.0uF, COUT=1.0uF, Ta=25°C, Unless otherwise noted.

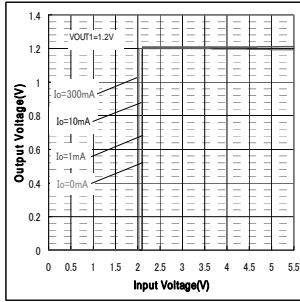

Fig.4. Output Voltage (VOUT1=1.2V)

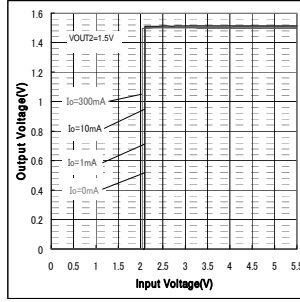

Fig.5. Output Voltage (VOUT2=1.5V)

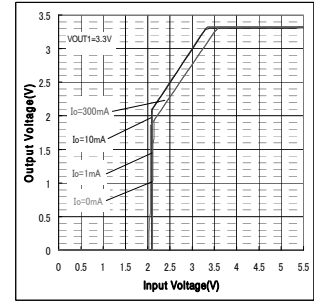

Fig.6. Output Voltage (VOUT1=3.3V)

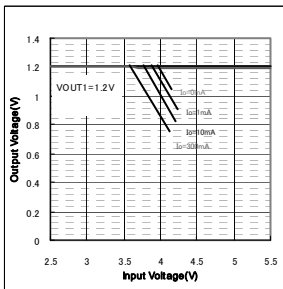

Fig.7. Line Regulation (VOUT1=1.2V)

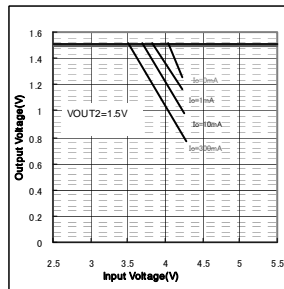

Fig.8. Line Regulation (VOUT2=1.5V)

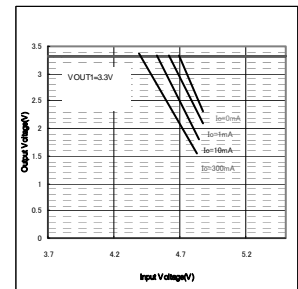

Fig.9. Line Regulation (VOUT1=3.3V)

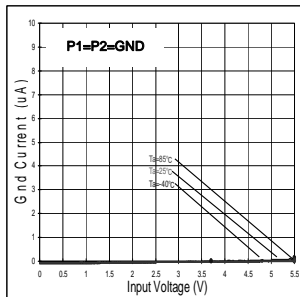

Fig.10. Circuit Current (VOUT1=1.8V, VOUT2=2.9V) EN1=EN2=GND

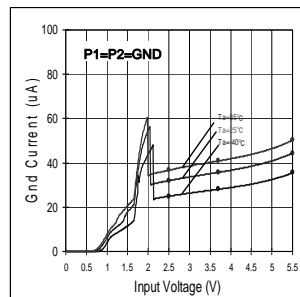

Fig.11. Circuit Current (VOUT1=1.8V, VOUT2=2.9V) EN1=VIN, EN2=GND

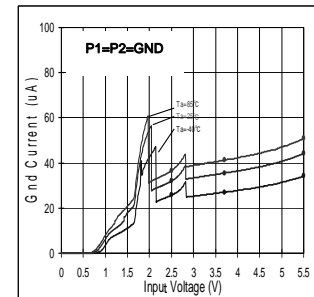

Fig.12. Circuit Current (VOUT1=1.8V, VOUT2=2.9V) EN1=GND, EN2=VIN

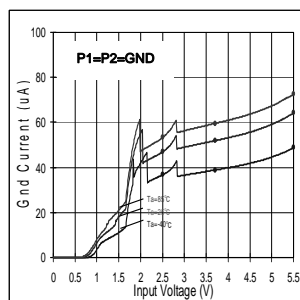

Fig.13. Circuit Current (VOUT1=1.8V, VOUT2=2.9V) EN1=EN2=VIN

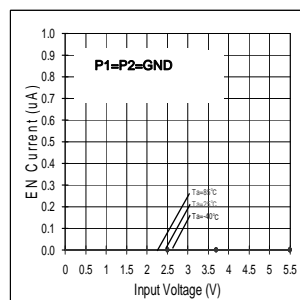

Fig.14. EN1 Input Current

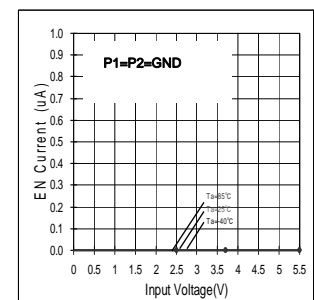

Fig.15. EN2 Input Current

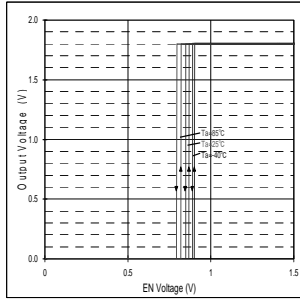

Fig.16. EN1 Threshold
(VOUT1=1.8V)

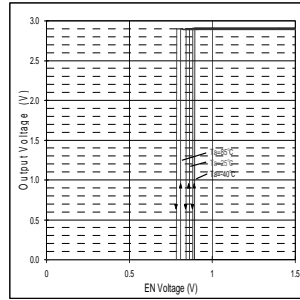

Fig.17. EN2 Threshold
(VOUT2=2.9V)

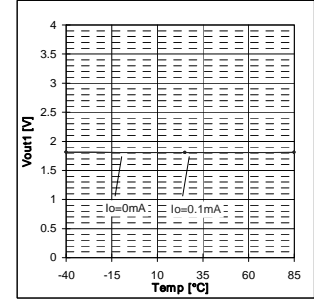

Fig.18. VOUT - Temp
(VOUT1=1.8V)

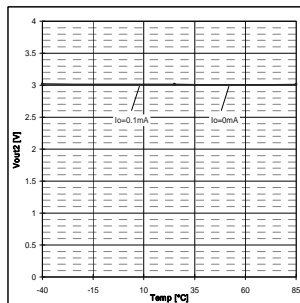

Fig.19. VOUT - Temp
(VOUT2=3.0V)

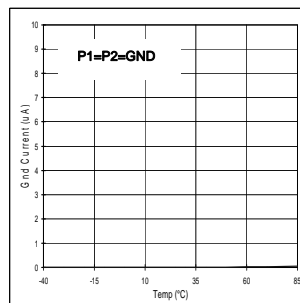

Fig.20. Icc - Temp
(VOUT1=1.8V, VOUT2=2.9V)
EN1=EN2=GND

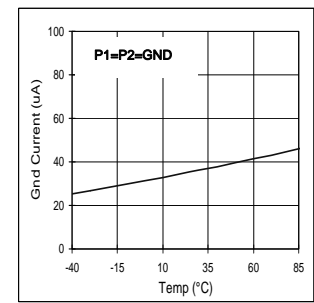

Fig.21. Icc - Temp
(VOUT1=1.8V, VOUT2=2.9V)
EN1=VIN, EN2=GND

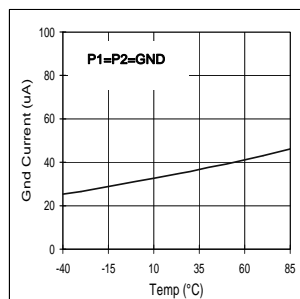

Fig.22. Icc - Temp
(VOUT1=1.8V, VOUT2=2.9V)
EN1=GND, EN2=VIN

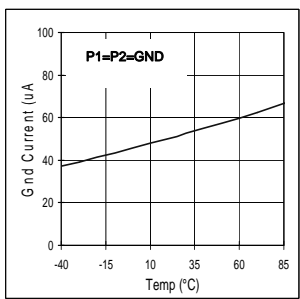

Fig.23. Icc - Temp
(VOUT1=1.8V, VOUT2=2.9V)
EN1=EN2=VIN

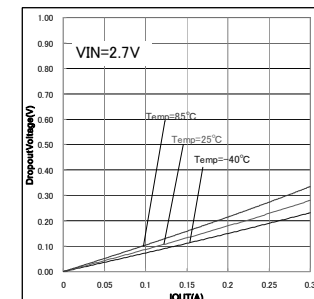

Fig.24. Drop Out Voltage
(VOUT1=2.8V)

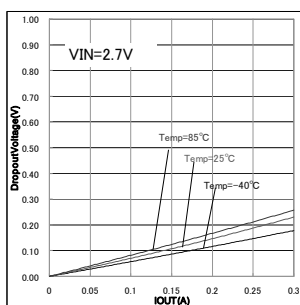

Fig.25. Drop Out Voltage
(VOUT2=2.8V)

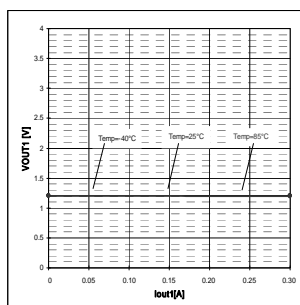

Fig.26. Load Regulation
(VOUT1=1.2V)

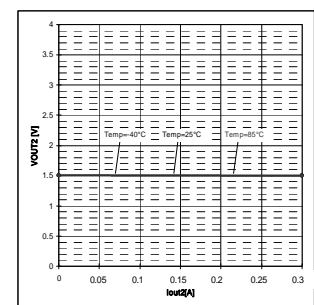

Fig.27. Load Regulation
(VOUT2=1.5V)

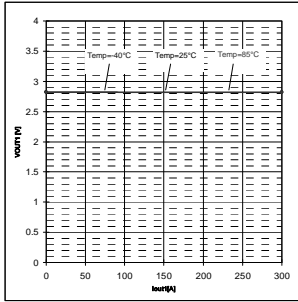

Fig.28. Load Regulation (VOUT1=2.8V)

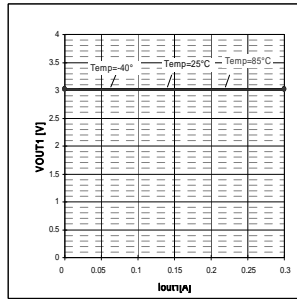

Fig.29. Load Regulation (VOUT2=3.0V)

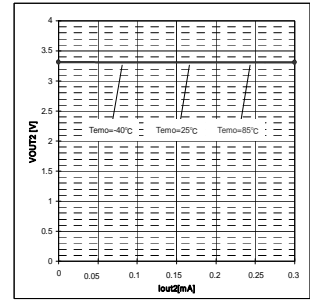

Fig.30. Load Regulation (VOUT2=3.3V)

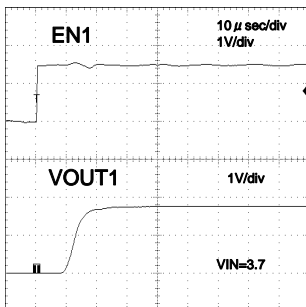

Fig.31. Start Up Time (VOUT1=1.8V) IOUT=0mA

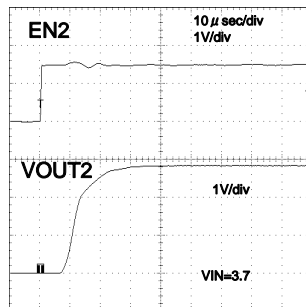

Fig.32. Start Up Time (VOUT2=2.9V) IOUT=0mA

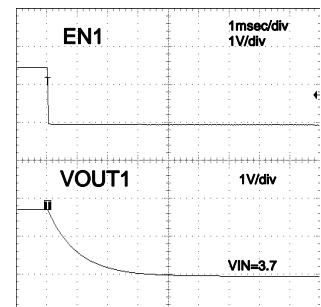

Fig.33. Discharge Time (VOUT1=1.8V) IOUT=0mA

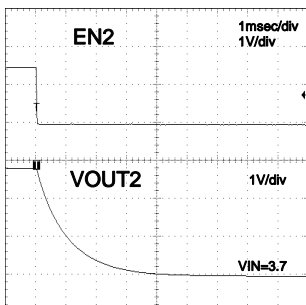

Fig.34. Discharge Time (VOUT2=2.9V) IOUT=0mA

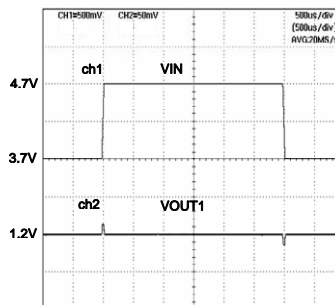

Fig.35. VIN Response (VOUT1=1.2V) IOUT=50mA

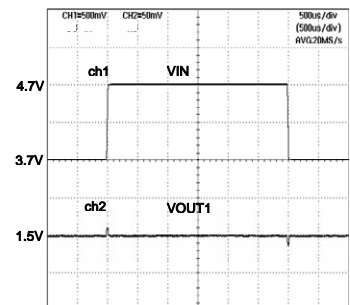

Fig.36. VIN Response (VOUT1=1.5V) IOUT=50mA

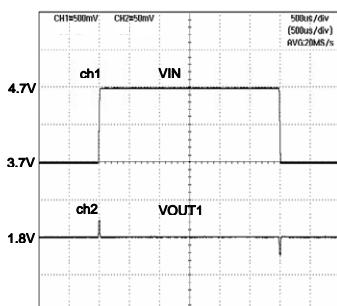

Fig.37. VIN Response (VOUT1=1.8V) IOUT=50mA

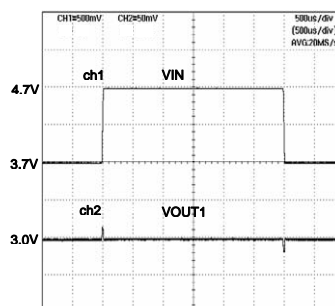

Fig.38. VIN Response (VOUT2=3.0V) IOUT=50mA

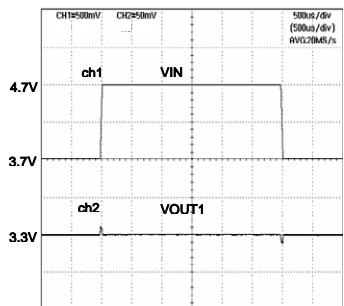

Fig.39. VIN Response (VOUT2=3.3V) IOUT=50mA

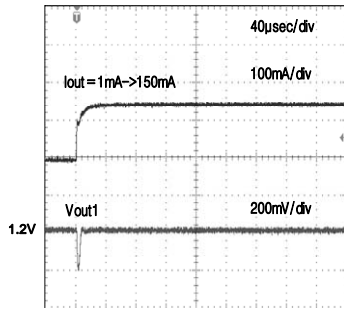

Fig.40. Load Response
(VOUT1=1.2V)
IOUT=1mA→150mA

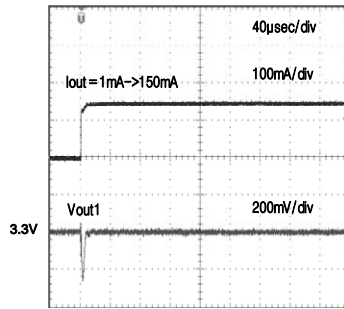

Fig.41. Load Response
(VOUT1=3.3V)
IOUT=1mA→150mA

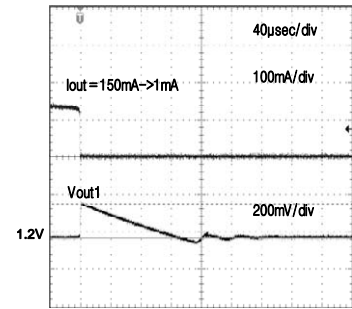

Fig.42. Load Response
(VOUT1=1.2V)
IOUT=150mA→1mA

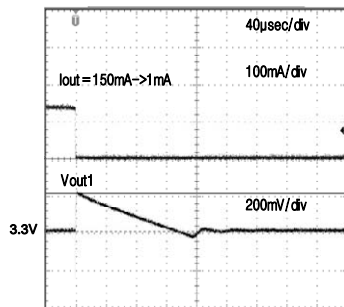

Fig.43. Load Response
(VOUT1=3.3V)
IOUT=150mA→1mA

●Example of EN1&EN2 used (P1=GND,P2=OPEN, VOUT1=1.8V, VOUT2=2.8V)

Output overshoot conditions

Whenever the LDO is turned ON, LDO1 output overshoot occurs in certain boot conditions.

In CASE2, the overshoot value is minimum, which boot order is EN1→EN2.

The maximum over shoot occurs in CASE3, which boot order is EN2→EN1.

The overshoot value differs between input voltages(VIN), output voltage setting and EN1, EN2 input timing interval.

CASE1: EN1 & EN2 Pins are shorted

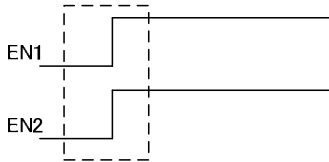

VIN=3.7V,EN2=EN1

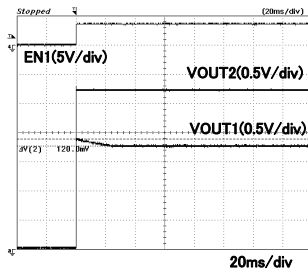

VIN=5.5V,EN2=EN1

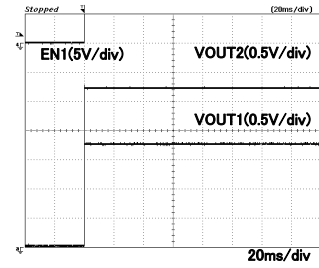

EN1 & EN2 Pins are independent

CASE2: EN1→EN2 operation(L→H)

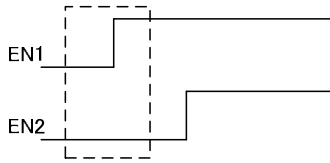

VIN=3.7V,EN2=L(OFF)

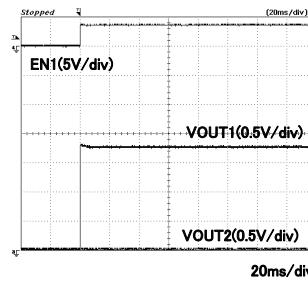

VIN=5.5V,EN2=L(OFF)

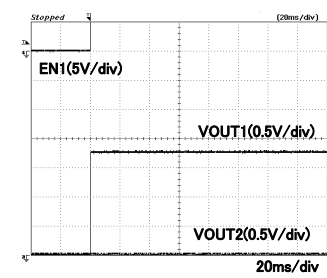

CASE3: EN2→EN1 operation(L→H)

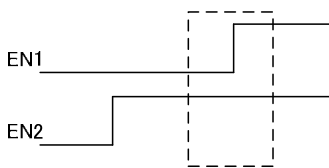

VIN=3.7V,EN2=H(ON)

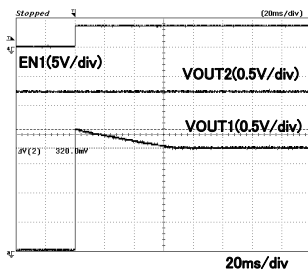

VIN=5.5V,EN2=H(ON)

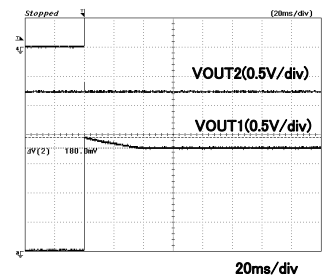

● Notes for use

- (1) Absolute maximum ratings
If applied voltage (VIN), operating temperature range (Topr), or other absolute maximum ratings are exceeded, there is a risk of damage. Since it is not possible to identify short, open, or other damage modes, if special modes in which absolute maximum ratings are exceeded are assumed, consider applying fuses or other physical safety measures.
- (2) Recommended operating range
This is the range within which it is possible to obtain roughly the expected characteristics. For electrical characteristics, it is those that are guaranteed under the conditions for each parameter. Even when these are within the recommended operating range, voltage and temperature characteristics are indicated.
- (3) Reverse connection of power supply connector
There is a risk of damaging the IC by reverse connection of the power supply connector. For protection from reverse connection, take measures such as externally placing a diode between the power supply and the power supply pin of the IC.
- (4) Power supply lines
In the design of the board pattern, make power supply and GND line wiring low impedance. When doing so, although the digital power supply and analog power supply are the same potential, separate the digital power supply pattern and analog power supply pattern to deter digital noise from entering the analog power supply due to the common impedance of the wiring patterns. Similarly take pattern design into account for GND lines as well. Furthermore, for all power supply pins of the IC, in conjunction with inserting capacitors between power supply and GND pins, when using electrolytic capacitors, determine constants upon adequately confirming that capacitance loss occurring at low temperatures is not a problem for various characteristics of the capacitors used.
- (5) GND voltage
Make the potential of a GND pin such that it will be the lowest potential even if operating below that. In addition, confirm that there are no pins for which the potential becomes less than a GND by actually including transition phenomena.
- (6) Shorts between pins and misinstallation
When installing in the set board, pay adequate attention to orientation and placement discrepancies of the IC. If it is installed erroneously, there is a risk of IC damage. There also is a risk of damage if it is shorted by a foreign substance getting between pins, between a pin and a power supply or GND.
- (7) Operation in strong magnetic fields
Be careful when using the IC in a strong magnetic field, since it may malfunction.
- (8) Inspection in set board
When inspecting the IC in the set board, since there is a risk of stress to the IC when capacitors are connected to low impedance IC pins, be sure to discharge for each process. Moreover, when getting it on and off of a jig in the inspection process, always connect it after turning off the power supply, perform the inspection, and remove it after turning off the power supply. Furthermore, as countermeasures against static electricity, use grounding in the assembly process and take appropriate care in transport and storage.
- (9) Input pins
Parasitic elements inevitably are formed on an IC structure due to potential relationships. Because parasitic elements operate, they give rise to interference with circuit operation and may be the cause of malfunctions as well as damage. Accordingly, take care not to apply a lower voltage than GND to an input pin or use the IC in other ways such that parasitic elements operate. Moreover, do not apply a voltage to an input pin when the power supply voltage is not being applied to the IC. Furthermore, when the power supply voltage is being applied, make each input pin a voltage less than the power supply voltage as well as within the guaranteed values of electrical characteristics.
- (10) Ground wiring pattern
When there is a small signal GND and a large current GND, it is recommended that you separate the large current GND pattern and small signal GND pattern and provide single point grounding at the reference point of the set so that voltage variation due to resistance components of the pattern wiring and large currents do not cause the small signal GND voltage to change. Take care that the GND wiring pattern of externally attached components also does not change.
- (11) Externally attached capacitors
When using ceramic capacitors for externally attached capacitors, determine constants upon taking into account a lowering of the rated capacitance due to DC bias and capacitance change due to factors such as temperature.
- (12) Thermal shutdown circuit (TSD)
When the junction temperature becomes 180°C (typ) or higher, the thermal shutdown circuit operates and turns the switch OFF. The thermal shutdown circuit, which is aimed at isolating the IC from thermal runaway as much as possible, is not aimed at the protection or guarantee of the IC. Therefore, do not continuously use the IC with this circuit operating or use the IC assuming its operation.
- (13) Thermal design
Perform thermal design in which there are adequate margins by taking into account the permissible dissipation (Pd) in actual states of use.

●Ordering part number

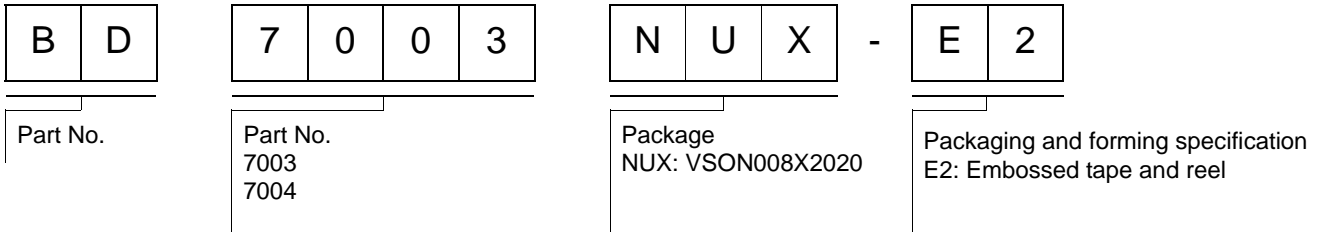

VSON008X2020

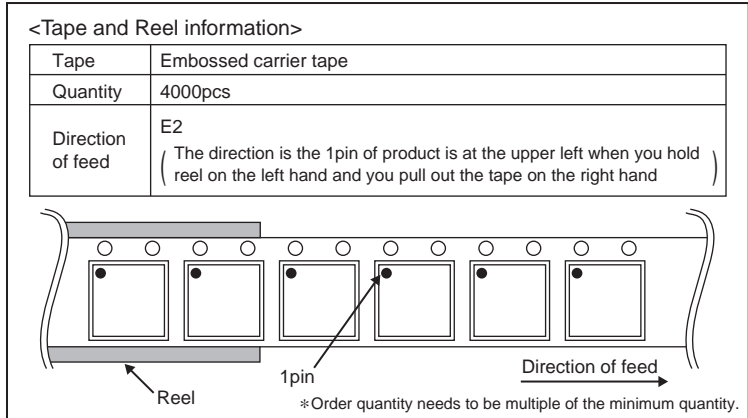
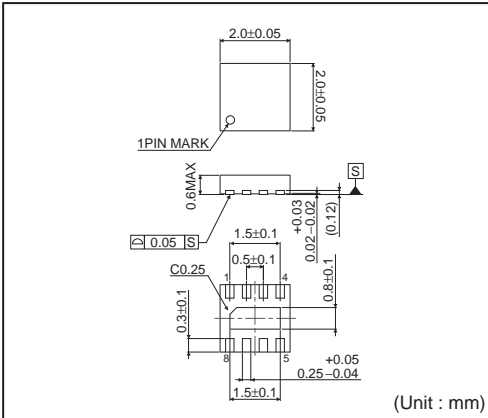

Notes

No copying or reproduction of this document, in part or in whole, is permitted without the consent of ROHM Co.,Ltd.

The content specified herein is subject to change for improvement without notice.

The content specified herein is for the purpose of introducing ROHM's products (hereinafter "Products"). If you wish to use any such Product, please be sure to refer to the specifications, which can be obtained from ROHM upon request.

Examples of application circuits, circuit constants and any other information contained herein illustrate the standard usage and operations of the Products. The peripheral conditions must be taken into account when designing circuits for mass production.

Great care was taken in ensuring the accuracy of the information specified in this document. However, should you incur any damage arising from any inaccuracy or misprint of such information, ROHM shall bear no responsibility for such damage.

The technical information specified herein is intended only to show the typical functions of and examples of application circuits for the Products. ROHM does not grant you, explicitly or implicitly, any license to use or exercise intellectual property or other rights held by ROHM and other parties. ROHM shall bear no responsibility whatsoever for any dispute arising from the use of such technical information.

The Products specified in this document are intended to be used with general-use electronic equipment or devices (such as audio visual equipment, office-automation equipment, communication devices, electronic appliances and amusement devices).

The Products specified in this document are not designed to be radiation tolerant.

While ROHM always makes efforts to enhance the quality and reliability of its Products, a Product may fail or malfunction for a variety of reasons.

Please be sure to implement in your equipment using the Products safety measures to guard against the possibility of physical injury, fire or any other damage caused in the event of the failure of any Product, such as derating, redundancy, fire control and fail-safe designs. ROHM shall bear no responsibility whatsoever for your use of any Product outside of the prescribed scope or not in accordance with the instruction manual.

The Products are not designed or manufactured to be used with any equipment, device or system which requires an extremely high level of reliability the failure or malfunction of which may result in a direct threat to human life or create a risk of human injury (such as a medical instrument, transportation equipment, aerospace machinery, nuclear-reactor controller, fuel-controller or other safety device). ROHM shall bear no responsibility in any way for use of any of the Products for the above special purposes. If a Product is intended to be used for any such special purpose, please contact a ROHM sales representative before purchasing.

If you intend to export or ship overseas any Product or technology specified herein that may be controlled under the Foreign Exchange and the Foreign Trade Law, you will be required to obtain a license or permit under the Law.



Thank you for your accessing to ROHM product informations.
More detail product informations and catalogs are available, please contact us.

ROHM Customer Support System

<http://www.rohm.com/contact/>