

Single Compression Contact: Board-to-Board (BTB)



Series 70-9155



Designers for ruggedized connectors to meet harsh environments continue to look for new products which will reduce size and cost without jeopardizing performance. The new Ultra-Low Profile (ULP) compression contact from AVX surface mounts to a PCB and provides a reliable compression connection to the mating board, even under extreme shock and vibration applications. With over 20 years of 1-Piece compression contact experience, this innovative contact offers full connector performance functionality at the individual contact level. Thus, allowing single contacts to be placed in any location or position on a PCB.

The high force beryllium copper contact is gold plated to maximize reliability and signal integrity. The current offering has two contacts with nominal heights of 1.0mm and 1.5mm. Add in the “Z” axis tolerance range and the compressed height covers 0.75mm up to 1.75mm. The contacts are supplied in tape and reel for easy SMT placement.

APPLICATIONS

- Industrial/Ruggedized handheld or portable devices
- BTB connection for any traditional power or signal application
- Ground connections between PCB's or housings

FEATURES AND BENEFITS

- Reliable gold plated Beryllium Copper contacts for high cycle life and signal integrity up to 1000 cycles
- Tape and reel packaged for automated SMT placement
- Sweeping beam design for pluggable/module applications
- Three gold plating options to match end product environmental or expected life requirements

ELECTRICAL

- Current Rating: 3 Amps
- Voltage Rating: Based on placement distance

ENVIRONMENTAL

- Operating Temperature: -40°C to +125°C

MECHANICAL

- Contact Material: Beryllium Copper
- Contact Plating: Gold over Nickel
- Durability: 50, 500 and 1000 cycles

HOW TO ORDER



6XX

Contact Description

Code	Nominal Operating Height	Contact Operating Height Range
610	1.00mm	0.75mm to 1.25mm
615	1.50mm	1.25mm to 1.75mm

00X

Contact Description

Code	Gold Thickness	Description	Availability
004	0.1µm	Nickel under Plate, Gold on Nose Tin on Remainder	Standard
006	0.4µm	Nickel under Plate, Gold on Nose Tin on Remainder	Special Order
008	0.8µm	Nickel under Plate, Gold on Nose Tin on Remainder	Special Order



Single Compression Contact: Board-to-Board (BTB)



Series 70-9155

70-9155-001-610-006
NOMINAL WORKING HEIGHT 1.00MM

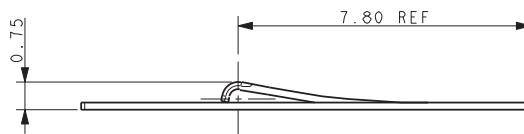
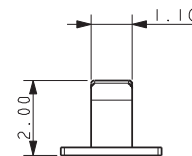
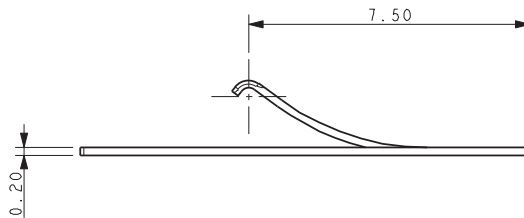
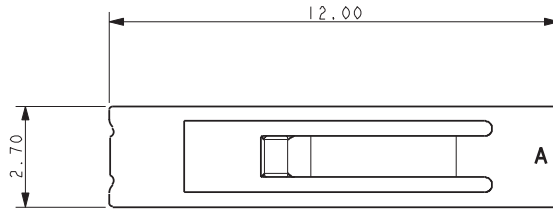

**FULLY DEFLECTED
CONTACT**

SUGGESTED MATING PCB LAYOUT

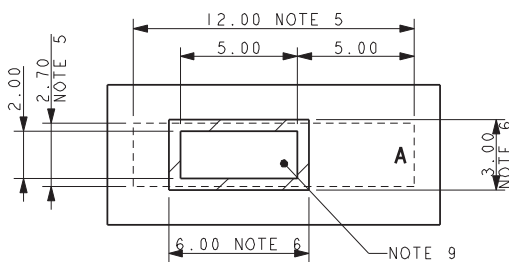

NOTES:

1. 9155 LOW PROFILE CONTACT, WORKING HEIGHT 0.75MM 5TO 1.25MM.
2. FOR FULL DETAILS REFER TO PRODUCT SPECIFICATION 201-01-153 AND APPLICATIONS NOTES 201-01-154.
3. MATERIAL: COPPER ALLOY 0.2MM THICK.
4. PLATING: NICKEL ALL OVER WITH GOLD ON CONTACT NOSE AND TIN ON THE REMAINDER. PARTS TO BE PACKED IN TAPE AND REEL. QTY PER REEL 3000.
5. OUTLINE OF CONNECTOR, ORIENTATION END "A".
6. AREA TO BE KEPT FREE OF SOLDER RESIST, FURTHER INFORMATION IN APPLICATION NOTES.
7. AREA BETWEEN PADS TO BE KEPT CLEAR OF TRACKS AND COMPONENTS.
8. SMT PADS PLATED TIN.
9. MATING PAD PLATED GOLD OVER NICKEL.

SUGGESTED SMT PCB LAYOUT

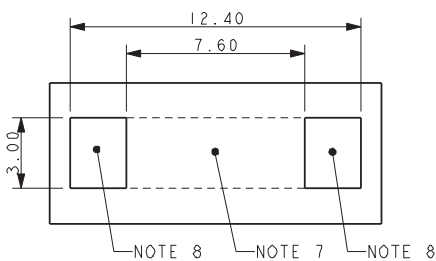

PACKING DETAILS

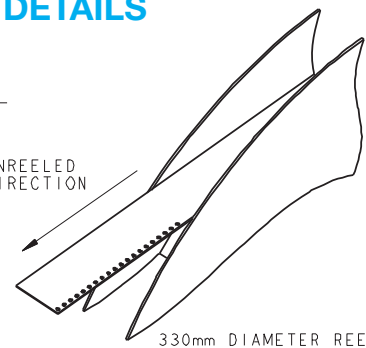
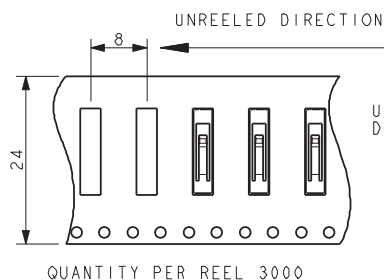

330mm DIAMETER REEL



Single Compression Contact: Board-to-Board (BTB)



Series 70-9155

70-9155-001-610-006 NOMINAL WORKING HEIGHT 1.50MM

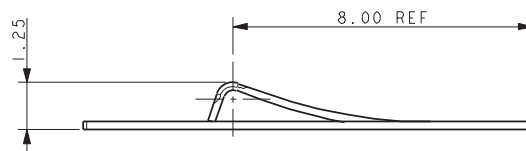
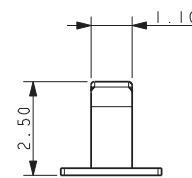
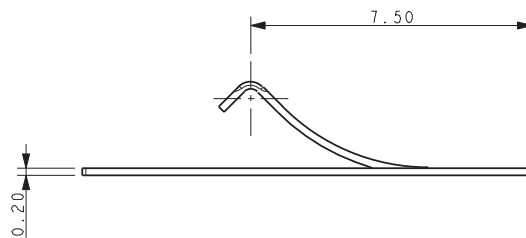
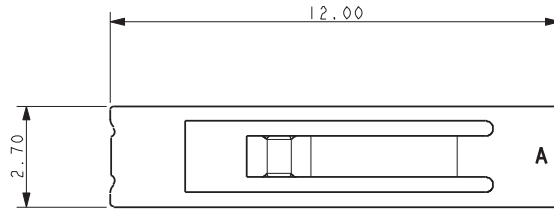

FULLY DEFLECTED CONTACT

SUGGESTED MATING PCB LAYOUT

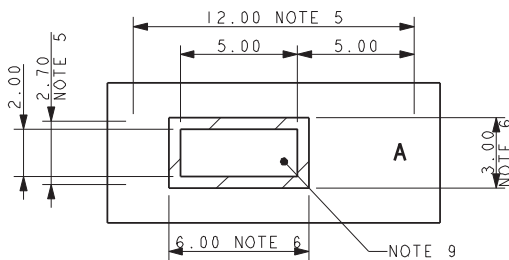

NOTES:

1. 9155 LOW PROFILE CONTACT, WORKING HEIGHT 0.75MM 5TO 1.25MM.
2. FOR FULL DETAILS REFER TO PRODUCT SPECIFICATION 201-01-153 AND APPLICATIONS NOTES 201-01-154.
3. MATERIAL: COPPER ALLOY 0.2MM THICK.
4. PLATING: NICKEL ALL OVER WITH GOLD ON CONTACT NOSE AND TIN ON THE REMAINDER. PARTS TO BE PACKED IN TAPE AND REEL. QTY PER REEL 3000.
5. OUTLINE OF CONNECTOR, ORIENTATION END "A".
6. AREA TO KEPT FREE OF SOLDER RESIST, FURTHER INFORMATION IN APPLICATION NOTES.
7. AREA BETWEEN PADS TO BE KEPT CLEAR OF TRACKS AND COMPONENTS.
8. SMT PADS PLATED TIN.
9. MATING PAD PLATED GOLD OVER NICKEL.

SUGGESTED SMT PCB LAYOUT

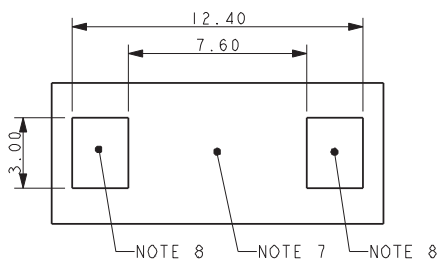

PACKING DETAILS

