

Right Angle Female

Style C 11 – 55 Contacts



- 55 signal contacts in 5 rows of 11 positions
- Daughter card applications
- Designed for gas tight press-fit installations
- Available with bottom pegs for secure P.C. board mounting
- This connector is designed for end positions only
- Supplied with or without upper ground return shield
- Reduced crosstalk version available

DIMENSIONS: millimeters (inches)

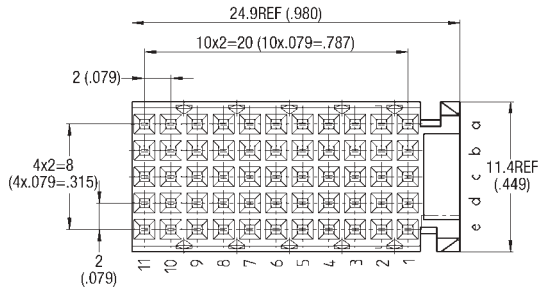
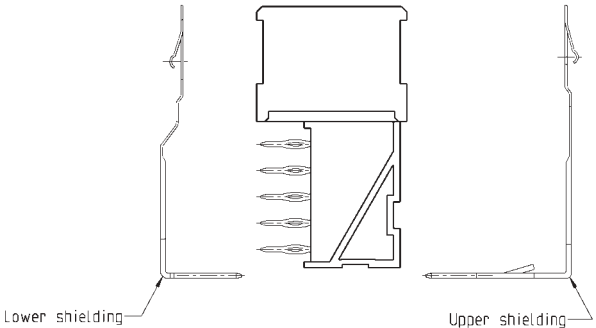
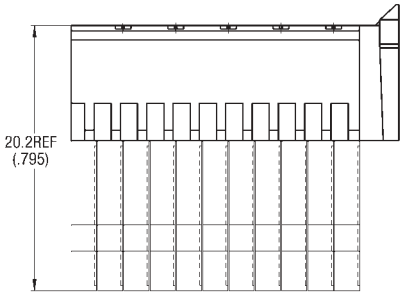



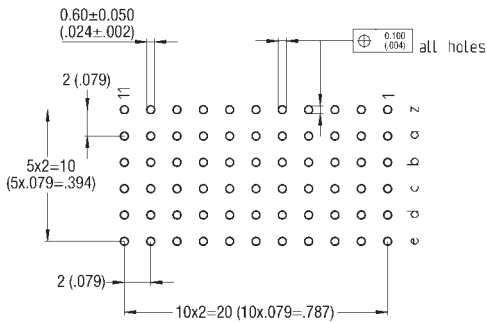

LAYOUT

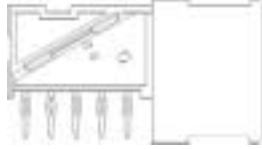
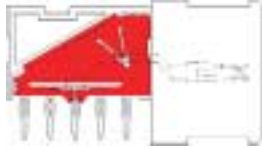

Right Angle Female

Style C 11 – 55 Contacts



Shielding Version	Cavity	Performance Class	Part Number
Without Shield 	55	1	27-7200-055-400-001
		2	27-7200-055-400-002
Reduced Crosstalk 	55	1	27-7200-055-401-001
		2	27-7200-055-401-002
Upper Shield 	55	1	27-7200-055-402-001
		2	27-7200-055-402-002
Upper Shield and Reduced Crosstalk 	55	1	27-7200-055-403-001
		2	27-7200-055-403-002
Lower Shield 		1	67-7200-2613-00-657
		2	67-7200-2613-00-675

Technical description and dimensions see page 20 and 29