

Features

- Carbon element
- 10-30 mm travel
- Center detent option
- Single or dual gang
- RoHS compliant*



The Model PDV Series is currently available, but not recommended for new designs.

PDV Series - Open Frame Slide Potentiometer

Electrical Characteristics

Taper..... Linear, audio
 Standard Resistance Range
 1 K ohms to 1 M ohms
 Standard Resistance Tolerance..... ±20 %
 Residual Resistance
 100 ohms or ±5 % max.

Environmental Characteristics

Operating Temperature... -10 °C to +50 °C
 Power Rating
 Linear 0.1 watt
 Audio 0.05 watt
 Maximum Operating Voltage - Linear
 10 mm Travel..... 100 VAC
 15 mm Travel..... 100 VAC
 20 mm Travel..... 200 VAC
 30 mm Travel..... 200 VAC
 Maximum Operating Voltage - Audio
 10 mm Travel..... 50 VAC
 15 mm Travel..... 50 VAC
 20 mm Travel..... 150 VAC
 30 mm Travel..... 150 VAC
 Sliding Noise 47 mV max.

Mechanical Characteristics

Operating Force 20 to 300 g-cm
 Detent Torque 50 to 400 g-cm
 Lever Stop Strength 3 kg-cm min.
 Sliding Life..... 10,000 cycles
 Std. Stroke Length 10, 15, 20, 30 mm
 Soldering Condition
 Wave 260 °C for 3 sec. max.
 Manual..... Not recommended

How To Order

PDV 10 - 2 1 P - 102 A

Model

Length of Travel
 • 10 = 10 mm
 • 15 = 15 mm
 • 20 = 20 mm
 • 30 = 30 mm

Detent Option
 • 2 = No Detent
 • 3 = Center Detent

Number of Gangs
 • 1 = Single Gang
 • 2 = Dual Gang

Mounting Type
 (refer to drawings)
 • P = Vertical Pins
 • M = Horizontal Pins

Resistance Code (See Table)

Resistance Taper
 • A = Audio Taper
 • B = Linear Taper

Other styles available.

Product Dimensions

PDVxx-x1P

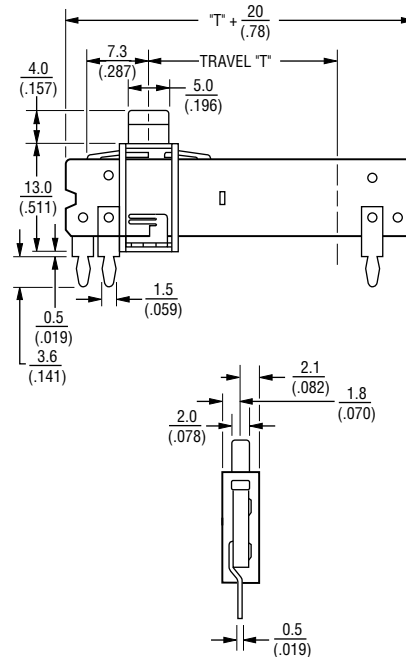

RECOMMENDED PCB LAYOUT

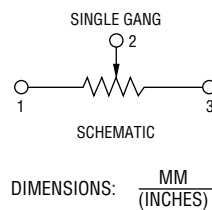
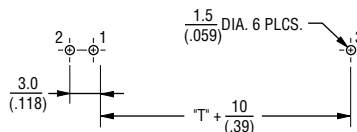

PDVxx-x2P

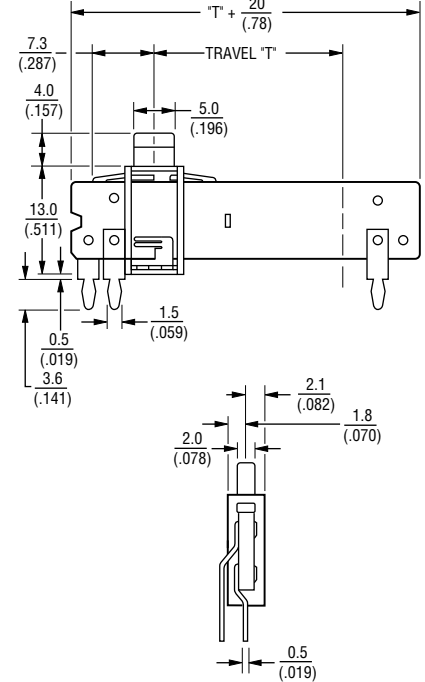

RECOMMENDED PCB LAYOUT

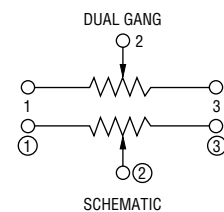
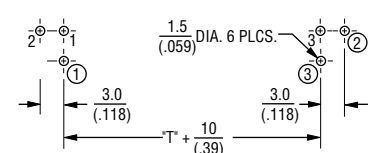

*RoHS Directive 2002/95/EC Jan. 27, 2003 including annex and RoHS Recast 2011/65/EU June 8, 2011. Specifications are subject to change without notice.

The device characteristics and parameters in this data sheet can and do vary in different applications and actual device performance may vary over time. Users should verify actual device performance in their specific applications.

Applications

- Audio/TV sets
- Car radio
- Amplifiers/mixers/drum machines/synthesizers
- PCs/monitors
- Appliances

PDV Series - Open Frame Slide Potentiometer BOURNS®

Product Dimensions

PDVxx-x1M

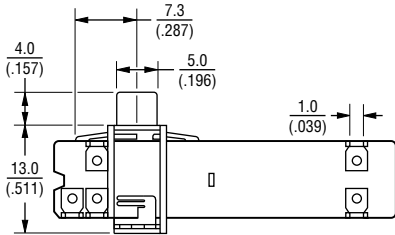

PDVxx-x2M

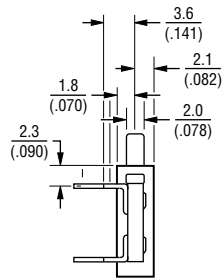
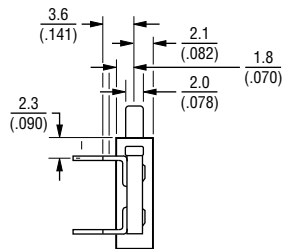
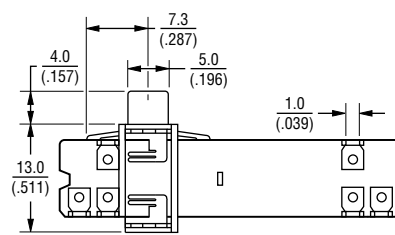

RECOMMENDED PCB LAYOUT

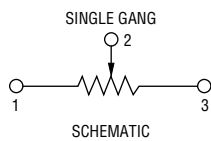
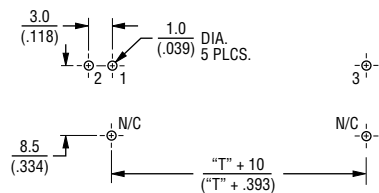

RECOMMENDED PCB LAYOUT

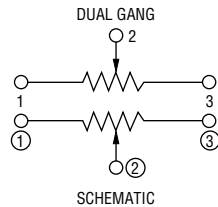
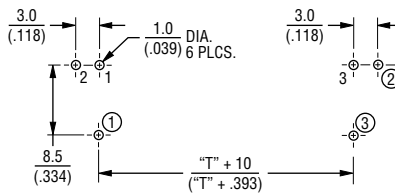

Standard Resistance Table

Resistance (Ohms)	Resistance Code
1,000	102
2,000	202
5,000	502
10,000	103
20,000	203
50,000	503
100,000	104
200,000	204
500,000	504
1,000,000	105

Derating Curve

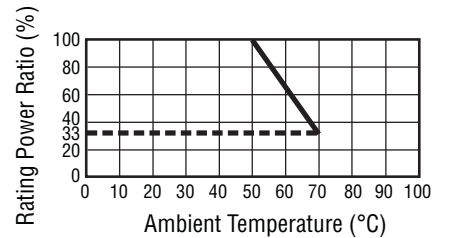

DIMENSIONS: $\frac{\text{MM}}{\text{(INCHES)}}$