

Notice for TAIYO YUDEN products

Please read this notice before using the TAIYO YUDEN products.

REMINDERS

- Product information in this catalog is as of October 2010. All of the contents specified herein are subject to change without notice due to technical improvements, etc. Therefore, please check for the latest information carefully before practical application or usage of the Products.

Please note that Taiyo Yuden Co., Ltd. shall not be responsible for any defects in products or equipment incorporating such products, which are caused under the conditions other than those specified in this catalog or individual specification.

- Please contact Taiyo Yuden Co., Ltd. for further details of product specifications as the individual specification is available.
- Please conduct validation and verification of products in actual condition of mounting and operating environment before commercial shipment of the equipment.
- All electronic components or functional modules listed in this catalog are developed, designed and intended for use in general electronics equipment.(for AV, office automation, household, office supply, information service, telecommunications, (such as mobile phone or PC) etc.). Before incorporating the components or devices into any equipment in the field such as transportation,(automotive control, train control, ship control), transportation signal, disaster prevention, medical, public information network (telephone exchange, base station) etc. which may have direct influence to harm or injure a human body, please contact Taiyo Yuden Co., Ltd. for more detail in advance. Do not incorporate the products into any equipment in fields such as aerospace, aviation, nuclear control, submarine system, military, etc. where higher safety and reliability are especially required.

In addition, even electronic components or functional modules that are used for the general electronic equipment, if the equipment or the electric circuit require high safety or reliability function or performances, a sufficient reliability evaluation check for safety shall be performed before commercial shipment and moreover, due consideration to install a protective circuit is strongly recommended at customer's design stage.

- The contents of this catalog are applicable to the products which are purchased from our sales offices or distributors (so called "TAIYO YUDEN' s official sales channel").
It is only applicable to the products purchased from any of TAIYO YUDEN' s official sales channel.
- Please note that Taiyo Yuden Co., Ltd. shall have no responsibility for any controversies or disputes that may occur in connection with a third party's intellectual property rights and other related rights arising from your usage of products in this catalog. Taiyo Yuden Co., Ltd. grants no license for such rights.

- Caution for export
Certain items in this catalog may require specific procedures for export according to "Foreign Exchange and Foreign Trade Control Law" of Japan, "U.S. Export Administration Regulations", and other applicable regulations. Should you have any question or inquiry on this matter, please contact our sales staff.

SMD INDUCTORS LARGE CURRENT TYPE



REFLOW

FEATURES

- SMD inductor.
- It corresponds to High current.
- Simple and original magnetic shield structure.

APPLICATIONS

- Power supply circuits / DC-DC converters in a variety of applications such as PDP TV, LCD TV, HDD, PC, etc.

OPERATING TEMPERATURE RANGE

- -25°C~105°C (Including self-generated heat)

ORDERING CODE

N R △ 1 0 0 5 0 T △ 1 0 0 M △

1 Type	2 External dimensions (W×H)	3 Packaging	4 Nominal inductance [μH]	5 Inductance tolerance	6 Internal code
NR△ Coating resin specification △=Blank Space	example 10050 10.0×5.0mm	T△ Tape & Reel △=Blank Space	example 1R3 1.3 100 10 101 100 ※R=decimal point	M ±20% N ±30%	△ Standard product △=Blank Space

EXTERNAL DIMENSIONS/STANDARD QUANTITY

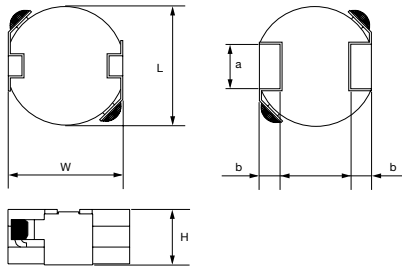

Recommended Land Patterns
Surface Mounting
• Mounting and soldering conditions should be checked beforehand.
• Applicable soldering process to these products is reflow soldering only.

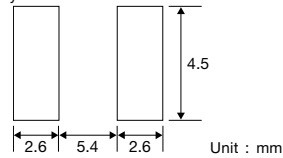

Type	L	W	H	a	b	Standard Quantity [pcs] Tape & Reel
NR 10050	10.0±0.3 (0.394±0.012)	9.8±0.5 (0.386±0.020)	5.0 max (0.197 max)	4.0 (0.16)	1.75 (0.07)	500

Unit : mm (inch)

AVAILABLE INDUCTANCE RANGE

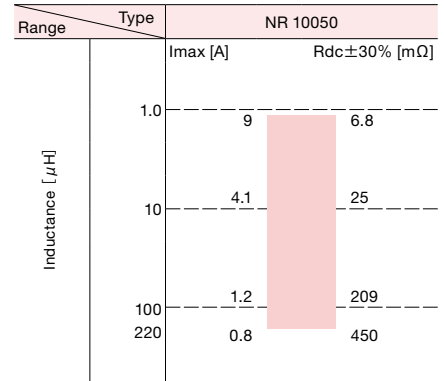

PART NUMBERS

NR 10050 type

Ordering code	EHS (Environmental Hazardous Substances)	Inductance [μH]	Inductance Tolerance	Self-resonant frequency [MHz] (min.)	DC Resistance [Ω] (±30%)	Rated current ※) [mA]		Measuring frequency [kHz]
						Saturation current Idc1	Temperature rise current Idc2	
NR10050T1R3N	RoHS	1.3	±30%	53	0.0068	11000	9000	100
NR10050T2R1N	RoHS	2.1		37	0.008	10000	8300	
NR10050T2R9N	RoHS	2.9		29	0.0093	8200	7300	
NR10050T3R8N	RoHS	3.8		26	0.013	7300	6800	
NR10050T4R9N	RoHS	4.9		23	0.015	6600	6000	
NR10050T6R5N	RoHS	6.5		19	0.018	6000	5200	
NR10050T100M	RoHS	10	±20%	15	0.025	4700	4100	
NR10050T150M	RoHS	15		11	0.035	3600	3200	
NR10050T220M	RoHS	22		10	0.045	2600	2500	
NR10050T330M	RoHS	33		8.2	0.066	2500	2100	
NR10050T470M	RoHS	47		7.0	0.092	2000	1800	
NR10050T680M	RoHS	68		5.6	0.144	1700	1500	
NR10050T101M	RoHS	100	±20%	4.6	0.209	1300	1200	
NR10050T221M	RoHS	220		3.0	0.450	1000	800	

※) The saturation current value (Idc1) is the DC current value having inductance decrease down to 30%. (at 20°C)

※) The temperature rise current value (Idc2) is the DC current value having temperature increase up to 40°C. (at 20°C)

※) The maximum rated current is the DC current value that satisfies both of current value Saturation current value and temperature rise current value. (at 20°C)

* This catalog contains the typical specification only due to the limitation of space. When you consider the purchase of our products, please check our specification. For details of each product (characteristics graph, reliability information, precautions for use, and so on), see our Web site (<http://www.ty-top.com/>) or CD catalogs.

DC Bias characteristics (Measured by HP4285A)

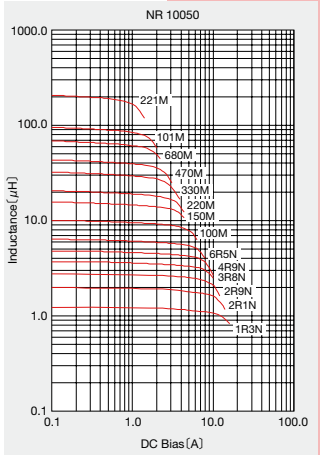

* This catalog contains the typical specification only due to the limitation of space. When you consider the purchase of our products, please check our specification. For details of each product (characteristics graph, reliability information, precautions for use, and so on), see our Web site (<http://www.ty-top.com/>) or CD catalogs.

PACKAGING

① Minimum Quantity

Type	Standard Quantity [pcs]
	Tape & Reel
NR 10050	500

② Tape Material

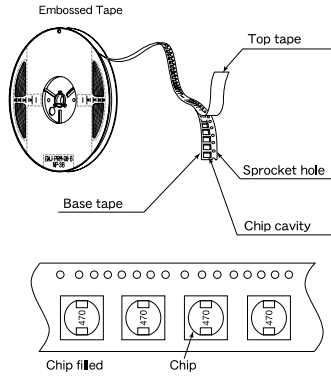

③ Taping dimensions

- Embossed tape 24mm wide (0.945 inches wide)

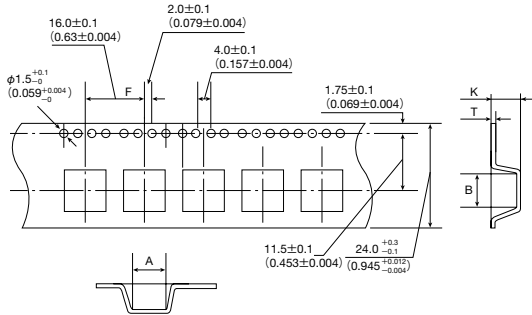

Type	Chip cavity		Insertion pitch	Tape thickness	
	A	B	F	T	K
NR 10050	10.4±0.1 (0.409±0.004)	9.9±0.1 (0.390±0.004)	16.0±0.1 (0.630±0.004)	0.5±0.05 (0.020±0.002)	5.7±0.1 (0.224±0.004)

Unit : mm (inch)

④ Leader and Blank portion

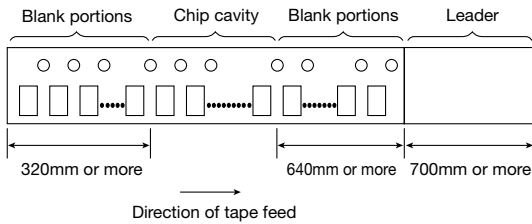

⑤ Reel size

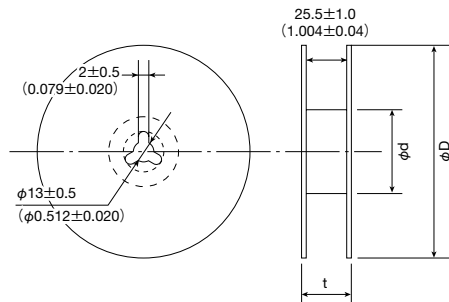

Type	Reel size (Reference values)		
	φD	φd	t (max.)
NR 10050	330±3 (12.99±0.118)	80±2 (3.15±0.078)	30.5 (1.201)

Unit : mm (inch)

⑥ Top Tape Strength

The top tape requires a peel-off force of 0.1 to 1.3N in the direction of the arrow as illustrated below.

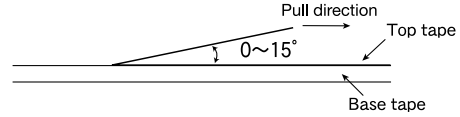

* This catalog contains the typical specification only due to the limitation of space. When you consider the purchase of our products, please check our specification. For details of each product (characteristics graph, reliability information, precautions for use, and so on), see our Web site (<http://www.ty-top.com/>) or CD catalogs.

RELIABILITY DATA

Wound Chip power inductor (NR, NS-series)

1. Operating Temperature Range						
NR30/40/50/60/80, NRV30, NRH24/30, NRS40/50/60/80 Type	-25~+120°C					
NR10050 Type	-25~+105°C					
NS12555, NS12565, NS12575Type	-40~+125°C					
[Test Method and Remarks] Including self-generated heat						
2. Storage Temperature Range						
NR30/40/50/60/80, NRV30, NRH24/30, NRS40/50/60/80 Type	-40~+85°C					
NR10050 Type						
NS12555, NS12565, NS12575Type						
[Test Method and Remarks] NR30/40/50/60/80, NRV30, NRH24/30, NRS40/50/60/80 Type, NR10050 Type, NS12555, NS12565, NS12575Type : -5 to 40°C for the product with taping.						
3. Rated current						
NR30/40/50/60/80, NRV30, NRH24/30, NRS40/50/60/80 Type	Within the specified tolerance					
NR10050 Type						
NS12555, NS12565, NS12575Type						
4. Inductance						
NR30/40/50/60/80, NRV30, NRH24/30, NRS40/50/60/80 Type	Within the specified tolerance					
NR10050 Type						
NS12555, NS12565, NS12575Type						
[Test Method and Remarks] LCR Meter : HP 4285A or equivalent, Measuring frequency : Specified frequency NR30/40/50/60/80, NRV30, NRH24/30, NRS40/50/60/80 Type, NS12555, NS12565, NS12575Type : LCR Meter : HP 4285A or equivalent, 100KHz, 1V NR10050 Type : LCR Meter : HP 4263A or equivalent, 100KHz, 1V						
5. DC Resistance						
NR30/40/50/60/80, NRV30, NRH24/30, NRS40/50/60/80 Type	Within the specified tolerance					
NR10050 Type						
NS12555, NS12565, NS12575Type						
[Test Method and Remarks] DC ohmmeter : HIOKI 3227 or equivalent						
6. Self resonance frequency						
NR30/40/50/60/80, NRV30, NRH24/30, NRS40/50/60/80 Type	Within the specification					
NR10050 Type						
NS12555, NS12565, NS12575Type						
[Test Method and Remarks] NR30/40/50/60/80, NRV30, NRH24/30, NRS40/50/60/80 Type, NR10050 Type, NS12555, NS12565, NS12575Type : Impedance analyzer/material analyzer : HP4291A or equivalent HP4191A, 4192A or equivalent						
7. Temperature characteristic						
NR30/40/50/60/80, NRV30, NRH24/30, NRS40/50/60/80 Type	Inductance change : Within ±20%					
NR10050 Type	Inductance change : Within ±15%					
NS12555, NS12565, NS12575Type						
[Test Method and Remarks] NR30/40/50/60/80, NRV30, NRH24/30, NRS40/50/60/80 Type, NR10050 Type : Measurement of inductance shall be taken at temperature range within -25°C~+85°C. With reference to inductance value at +20°C., change rate shall be calculated. NS12555, NS12565, NS12575Type : Measurement of inductance shall be taken at temperature range within -40°C~+125°C. With reference to inductance value at +20°C., change rate shall be calculated.						
Change of maximum inductance deviation in step 1 to 5						
Temperature at step 1	20°C					
Temperature at step 2	Minimum operating temperature					
Temperature at step 3	20°C (Standard temperature)					
Temperature at step 4	Maximum operating temperature					
Temperature at step 5	20°C					
8. Resistance to flexure of substrate						
NR30/40/50/60/80, NRV30, NRH24/30, NRS40/50/60/80 Type	No damage					
NR10050 Type	No damage					
NS12555, NS12565, NS12575Type						
[Test Method and Remarks] NR30/40/50/60/80, NRV30, NRH24/30, NRS40/50/60/80 Type, NS12555, NS12565, NS12575Type : The test samples shall be soldered to the test board by the reflow. As illustrated below, apply force in the direction of the arrow indicating until deflection of the test board reaches to 2 mm. Test board size : 100×40×1.0 Test board material : glass epoxy-resin Solder cream thickness : 0.10 (NR30/40, NRS40, NRH24/30, NRV30) 0.15 (NR50/60/80, NRS40/50/60, NS12555, NS12565, NS12575Type)						
Land dimension (NRH24)	Land dimension (NR30, NRH30, NRV30)	Land dimension (NR40, NRS40)	Land dimension (NR50, NRS50)	Land dimension (NR60, NRS60)	Land dimension (NR80)	Land dimension (NS12555/NS12565/NS12575)
0.7, 0.75, 0.7	0.8, 1.4, 0.8	1.2, 1.6, 1.2	1.5, 2.1, 1.5	1.6, 3.1, 1.6	1.8, 3.8, 1.8	2.5, 8.6, 2.5
2.0	2.7	3.7	4.0	5.7	7.5	3.2
Unit : mm						

* This catalog contains the typical specification only due to the limitation of space. When you consider the purchase of our products, please check our specification. For details of each product (characteristics graph, reliability information, precautions for use, and so on), see our Web site (<http://www.ty-top.com/>) or CD catalogs.

RELIABILITY DATA

Wound Chip power inductor (NR, NS-series)

9. Insulation resistance : between wires

NR30/40/50/60/80, NRV30, NRH24/30, NRS40/50/60/80 Type	
NR10050 Type	
NS12555, NS12565, NS12575Type	

10. Insulation resistance : between wire and core

NR30/40/50/60/80, NRV30, NRH24/30, NRS40/50/60/80 Type	
NR10050 Type	
NS12555, NS12565, NS12575Type	

11. Withstanding voltage : between wire and core

NR30/40/50/60/80, NRV30, NRH24/30, NRS40/50/60/80 Type	
NR10050 Type	
NS12555, NS12565, NS12575Type	

12. Adhesion of terminal electrode

NR30/40/50/60/80, NRV30, NRH24/30, NRS40/50/60/80 Type	Shall not come off PC board
NR10050 Type	
NS12555, NS12565, NS12575Type	

[Test Method and Remarks]

NR30/40/50/60/80, NRV30, NRH24/30, NRS40/50/60/80 Type, NS12555, NS12565, NS12575 Type :

The test samples shall be soldered to the test board by the reflow.

- Applied force : 10N to X and Y directions.
- Duration : 5s.
- Solder cream thickness : 0.15mm.

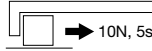

NR10050 Type :

- Applied force : 5N to X and Y directions.
- Duration : 5s.

13. Resistance to vibration

NR30/40/50/60/80, NRV30, NRH24/30, NRS40/50/60/80 Type	Inductance change : Within $\pm 10\%$ No significant abnormality in appearance.
NR10050 Type	
NS12555, NS12565, NS12575Type	

[Test Method and Remarks]

NR30/40/50/60/80, NRV30, NRH24/30, NRS40/50/60/80 Type, NR10050 Type, NS12555, NS12565, NS12575Type :

The test samples shall be soldered to the test board by the reflow.

Then it shall be submitted to below test conditions.

Frequency Range	10~55Hz	
Total Amplitude	1.5mm (May not exceed acceleration 196m/s ²)	
Sweeping Method	10Hz to 55Hz to 10Hz for 1min.	
Time	X	For 2 hours on each X, Y, and Z axis.
	Y	
	Z	

Recovery : At least 2hrs of recovery under the standard condition after the test, followed by the measurement within 48hrs.

14. Solderability

NR30/40/50/60/80, NRV30, NRH24/30, NRS40/50/60/80 Type	At least 90% of surface of terminal electrode is covered by new solder.
NR10050 Type	
NS12555, NS12565, NS12575Type	

[Test Method and Remarks]

The test samples shall be dipped in flux, and then immersed in molten solder as shown in below table.

Flux : Methanol solution containing rosin 25%.

NR30/40/50/60/80, NRV30, NRH24/30, NRS40/50/60/80 Type, NS12555, NS12565, NS12575 Type :

Solder Temperature	245 \pm 5 $^{\circ}$ C
Time	5 \pm 1.0 sec.

※Immersion depth : All sides of mounting terminal shall be immersed.

15. Resistance to soldering heat

NR30/40/50/60/80, NRV30, NRH24/30, NRS40/50/60/80 Type	Inductance change : Within $\pm 10\%$ No significant abnormality in appearance.
NR10050 Type	
NS12555, NS12565, NS12575Type	

[Test Method and Remarks]

NR30/40/50/60/80, NRV30, NRH24/30, NRS40/50/60/80 Type, NR10050 Type, NS12555, NS12565, NS12575 Type :

The test sample shall be exposed to reflow oven at 230 \pm 5 $^{\circ}$ C for 40 seconds, with peak temperature at 260 \pm 5 $^{\circ}$ C for 5 seconds, 2 times.

NR6020 Type :

The test sample shall be exposed to reflow oven at 230 \pm 5 $^{\circ}$ C for 40 seconds, with peak temperature at 250 \pm 5 $^{\circ}$ C for 5 seconds, 2 times.

Test board thickness : 1.0mm (NR30/40/50/60/80, NRV30, NRH24/30, NRS40/50/60/80 Type, NS12555, NS12565, NS12575 Type)
1.6mm (NR10050 Type)

Test board material : glass epoxy-resin

* This catalog contains the typical specification only due to the limitation of space. When you consider the purchase of our products, please check our specification. For details of each product (characteristics graph, reliability information, precautions for use, and so on), see our Web site (<http://www.ty-top.com/>) or CD catalogs.

RELIABILITY DATA

Wound Chip power inductor (NR, NS-series)

16. Thermal shock

NR30/40/50/60/80, NRV30, NRH24/30, NRS40/50/60/80 Type	Inductance change : Within $\pm 10\%$ No significant abnormality in appearance.
NR10050 Type	
NS12555, NS12565, NS12575Type	

[Test Method and Remarks]

NR30/40/50/60/80, NRV30, NRH24/30, NRS40/50/60/80 Type, NR10050 Type, NS12555, NS12565, NS12575Type :

The test samples shall be soldered to the test board by the reflow. The test samples shall be placed at specified temperature for specified time by step 1 to step 4 as shown in below table in sequence. The temperature cycle shall be repeated 100 cycles.

Conditions of 1 cycle		
Step	Temperature (°C)	Duration (min)
1	-40 \pm 3	30 \pm 3
2	Room temperature	Within 3
3	+85 \pm 2	30 \pm 3
4	Room temperature	Within 3

17. Damp heat

NR30/40/50/60/80, NRV30, NRH24/30, NRS40/50/60/80 Type	Inductance change : Within $\pm 10\%$ No significant abnormality in appearance.
NR10050 Type	
NS12555, NS12565, NS12575Type	Inductance change : Within $\pm 10\%$ No significant abnormality in appearance.

[Test Method and Remarks]

NR30/40/50/60/80, NRV30, NRH24/30, NRS40/50/60/80 Type, NS12555, NS12565, NS12575Type :

The test samples shall be soldered to the test board by the reflow.

The test samples shall be placed in thermostatic oven set at specified temperature and humidity as shown in below table.

Temperature	60 \pm 2°C
Humidity	90~95%RH
Time	500+24/-0 hour

18. Loading under damp heat

NR30/40/50/60/80, NRV30, NRH24/30, NRS40/50/60/80 Type	Inductance change : Within $\pm 10\%$ No significant abnormality in appearance.
NR10050 Type	
NS12555, NS12565, NS12575Type	

[Test Method and Remarks]

NR30/40/50/60/80, NRV30, NRH24/30, NRS40/50/60/80 Type, NR10050 Type, NS12555, NS12565, NS12575Type :

The test samples shall be soldered to the test board by the reflow.

The test samples shall be placed in thermostatic oven set at specified temperature and humidity and applied the rated current continuously as shown in below table.

Temperature	60 \pm 2°C
Humidity	90~95%RH
Applied current	Rated current
Time	500+24/-0 hour

19. Low temperature life test

NR30/40/50/60/80, NRV30, NRH24/30, NRS40/50/60/80 Type	Inductance change : Within $\pm 10\%$ No significant abnormality in appearance.
NR10050 Type	
NS12555, NS12565, NS12575Type	

[Test Method and Remarks]

NR30/40/50/60/80, NRV30, NRH24/30, NRS40/50/60/80 Type, NR10050 Type, NS12555, NS12565, NS12575Type :

The test samples shall be soldered to the test board by the reflow.

After that, the test samples shall be placed at test conditions as shown in below table.

Temperature	-40 \pm 2°C
Time	500+24/-0 hour

20. High temperature life test

NR30/40/50/60/80, NRV30, NRH24/30, NRS40/50/60/80 Type	Inductance change : Within $\pm 10\%$ No significant abnormality in appearance.
NR10050 Type	
NS12555, NS12565, NS12575Type	

[Test Method and Remarks]

NR10050 Type :

Temperature	105 \pm 3°C
Time	500+24/-0 hour

Recovery : At least 2hrs of recovery under the standard condition after the test, followed by the measurement within 48 hrs.

21. Loading at high temperature life test

NR30/40/50/60/80, NRV30, NRH24/30, NRS40/50/60/80 Type	Inductance change : Within $\pm 10\%$ No significant abnormality in appearance.
NR10050 Type	
NS12555, NS12565, NS12575Type	Inductance change : Within $\pm 10\%$ No significant abnormality in appearance.

[Test Method and Remarks]

NR30/40/50/60/80, NRV30, NRH24/30, NRS40/50/60/80 Type, NS12555, NS12565, NS12575Type :

The test samples shall be soldered to the test board by the reflow soldering.

Temperature	85 \pm 2°C
Applied current	Rated current
Time	500+24/-0 hour

* This catalog contains the typical specification only due to the limitation of space. When you consider the purchase of our products, please check our specification. For details of each product (characteristics graph, reliability information, precautions for use, and so on), see our Web site (<http://www.ty-top.com/>) or CD catalogs.

RELIABILITY DATA

Wound Chip power inductor (NR, NS-series)

22. Standard condition	
NR30/40/50/60/80, NRV30, NRH24/30, NRS40/50/60/80 Type	Standard test condition : Unless otherwise specified, temperature is $20 \pm 15^{\circ}\text{C}$ and $65 \pm 20\%$ of relative humidity. When there is any question concerning measurement result: In order to provide correlation data, the test shall be condition of $20 \pm 2^{\circ}\text{C}$ of temperature, $65 \pm 5\%$ relative humidity. Inductance is in accordance with our measured value.
NR10050 Type	
NS12555, NS12565, NS12575 Type	

* This catalog contains the typical specification only due to the limitation of space. When you consider the purchase of our products, please check our specification.
For details of each product (characteristics graph, reliability information, precautions for use, and so on), see our Web site (<http://www.ty-top.com/>) or CD catalogs.

PRECAUTIONS

Wound Chip power inductor (NR, NS-series)

1. Circuit Design	
Precautions	<ul style="list-style-type: none"> ◆ Operating environment <ol style="list-style-type: none"> 1. The products described in this specification are intended for use in general electronic equipment, (office supply equipment, telecommunications systems, measuring equipment, and household equipment). They are not intended for use in mission-critical equipment or systems requiring special quality and high reliability (traffic systems, safety equipment, aerospace systems, nuclear control systems and medical equipment including life-support systems,) where product failure might result in loss of life, injury or damage. For such uses, contact TAIYO YUDEN Sales Department in advance.
2. PCB Design	
Precautions	<ul style="list-style-type: none"> ◆ Land pattern design <ol style="list-style-type: none"> 1. Please refer to a recommended land pattern.
Technical considerations	<ul style="list-style-type: none"> ◆ Land pattern design <ul style="list-style-type: none"> Surface Mounting • Mounting and soldering conditions should be checked beforehand. • Applicable soldering process to this products is reflow soldering only.
3. Considerations for automatic placement	
Precautions	<ul style="list-style-type: none"> ◆ Adjustment of mounting machine <ol style="list-style-type: none"> 1. Excessive impact load should not be imposed on the products when mounting onto the PC boards. 2. Mounting and soldering conditions should be checked beforehand.
Technical considerations	<ul style="list-style-type: none"> ◆ Adjustment of mounting machine <ol style="list-style-type: none"> 1. When installing products, care should be taken not to apply distortion stress as it may deform the products.
4. Soldering	
Precautions	<ul style="list-style-type: none"> ◆ Reflow soldering <ol style="list-style-type: none"> 1. Please contact any of our offices for a reflow soldering, and refer to the recommended condition specified. 2. The product shall be used reflow soldering only. 3. Please do not add any stress to a product until it returns in normal temperature after reflow soldering. ◆ Lead free soldering <ol style="list-style-type: none"> 1. When using products with lead free soldering, we request to use them after confirming adhesion, temperature of resistance to soldering heat, soldering etc sufficiently. ◆ Recommended conditions for using a soldering iron (NR10050 Type) <ul style="list-style-type: none"> • Put the soldering iron on the land-pattern. • Soldering iron's temperature - Below 350°C • Duration - 3 seconds or less • The soldering iron should not directly touch the inductor.
Technical considerations	<ul style="list-style-type: none"> ◆ Reflow soldering <ol style="list-style-type: none"> 1. If products are used beyond the range of the recommended conditions, heat stresses may deform the products, and consequently degrade the reliability of the products. <ul style="list-style-type: none"> • NR30/40/50/60/80, NRV30, NRH24/30, NRS40/50/60/80 Type, NR10050, NS12555, NS12565, NS12575 Type Recommended reflow condition (Pb free solder)
5. Cleaning	
Precautions	<ul style="list-style-type: none"> ◆ Cleaning conditions <ol style="list-style-type: none"> 1. Washing by supersonic waves shall be avoided.
Technical considerations	<ul style="list-style-type: none"> ◆ Cleaning conditions <ol style="list-style-type: none"> 1. if washed by supersonic waves, the products might be broken.
6. Handling	
Precautions	<ul style="list-style-type: none"> ◆ Handling <ol style="list-style-type: none"> 1. Keep the product away from all magnets and magnetic objects. ◆ Breakaway PC boards (splitting along perforations) <ol style="list-style-type: none"> 1. When splitting the PC board after mounting product, care should be taken not to give any stresses of deflection or twisting to the board. 2. Board separation should not be done manually, but by using the appropriate devices. ◆ Mechanical considerations <ol style="list-style-type: none"> 1. Please do not give the product any excessive mechanical shocks. 2. Please do not add any shock and power to a product in transportation. ◆ Pick-up pressure <ol style="list-style-type: none"> 1. Please do not push to add any pressure to a winding part. Please do not give any shock and push into a ferrite core exposure part. ◆ Packing <ol style="list-style-type: none"> 1. Please avoid accumulation of a packing box as much as possible.
Technical considerations	<ul style="list-style-type: none"> ◆ Breakaway PC boards (splitting along perforations) <ol style="list-style-type: none"> 1. The position of the product on PCBs shall be carefully considered to minimize the stress caused from splitting of the PCBs. ◆ Mechanical considerations <ol style="list-style-type: none"> 1. There is a case to be damaged by a mechanical shock. 2. There is a case to be broken by the handling in transportation. ◆ Pick-up pressure <ol style="list-style-type: none"> 1. Damage and a characteristic can vary with an excessive shock or stress. ◆ Packing <ol style="list-style-type: none"> 1. If packing boxes are accumulated, that could cause a deformation on packing tapes or a damage on the products.
7. Storage conditions	
Precautions	<ul style="list-style-type: none"> ◆ Storage <ol style="list-style-type: none"> 1. To maintain the solderability of terminal electrodes and to keep the packing material in good condition, temperature and humidity in the storage area should be controlled. <ul style="list-style-type: none"> • Recommended conditions Ambient temperature: -5~40°C Humidity : Below 70% RH <p>The ambient temperature must be kept below 30°C. Even under ideal storage conditions, solderability of products electrodes may decrease as time passes. For this reason, product should be used within 6 months from the time of delivery. In case of storage over 6 months, solderability shall be checked before actual usage.</p>
Technical considerations	<ul style="list-style-type: none"> ◆ Storage <ol style="list-style-type: none"> 1. Under a high temperature and humidity environment, problems such as reduced solderability caused by oxidation of terminal electrodes and deterioration of taping/packaging materials may take place.

* This catalog contains the typical specification only due to the limitation of space. When you consider the purchase of our products, please check our specification. For details of each product (characteristics graph, reliability information, precautions for use, and so on), see our Web site (<http://www.ty-top.com/>) or CD catalogs.