

High Reliability Serial EEPROMs

WL-CSP EEPROM family

Microwire Bus



BU9891GUL-W

No.10001EAT10

●Description

BU9891GUL-W is serial EEPROM of serial 3-line interface method

●Features

- 1) 3-line communications of chip select, serial clock, serial data input / output (the case where input and output are shared)
- 2) Actions available at high speed 2MHz clock (2.5~5.5V)
- 3) Speed write available (write time 5ms max.)
- 4) 1.7~5.5V single power source action
- 5) Address auto increment function at read action
- 6) Write mistake prevention function
 - Write prohibition at power on
 - Write prohibition by command code
 - Write mistake prevention function at low voltage
- 7) Program cycle auto delete and auto end function
- 8) Program condition display by READY / BUSY
- 9) Low current consumption
 - At write action (at 5V): 1.2mA (Typ.)
 - At read action (at 5V): 0.3mA (Typ.)
 - At standby action (at 5V): 0.1μA (Typ.) (CMOS input)
- 10) Data retention for 40 years
- 11) Data rewrite up to 100,000 times
- 12) Data at shipment all addresses FFFFh

| Capacity | Bit format | Type | Power source voltage | Package type |
|----------|------------|-------------|----------------------|--------------|
| 4Kbit | 256 × 16 | BU9891GUL-W | 1.7~5.5V | VCSP50L1 |

●Absolute Maximum Ratings(Ta=25°C)

| Parameter | Symbol | Ratings | Unit |
|---------------------------|--------|-------------------|------|
| Impressed voltage | VCC | -0.3~+6.5 | V |
| Permissible dissipation | Pd | 220 (VCSP50L1) *1 | mW |
| Storage temperature range | Tstg | -65~+125 | °C |
| Action temperature range | Topr | -40~+85 | °C |
| Terminal voltage | - | -0.3~VCC+0.3 | V |

* When using at Ta=25°C or higher, 2.2mW (to be reduced per 1°C).

●Recommended action conditions

| Parameter | Symbol | Ratings | Unit |
|----------------------|-----------------|---------|------|
| Power source voltage | VCC | 1.7~5.5 | V |
| Input voltage | V _{IN} | 0~VCC | |

●Memory cell characteristics (VCC=1.7~5.5V)

| Parameter | Limit | | | Unit | Condition |
|---------------------------------|---------|------|------|-------|-----------|
| | Min. | Typ. | Max. | | |
| Number of data rewrite times *1 | 100,000 | - | - | Times | Ta=25°C |
| Data hold years *1 | 40 | - | - | Years | Ta=25°C |

○Shipment data all address FFFFh

*1 Not 100% TESTED

●Electrical characteristics

(Unless otherwise specified, VCC=1.7~5.5V, Ta=-40~+85°C)

| Parameter | Symbol | Limits | | | Unit | Condition |
|-------------------------------|------------------|-----------|------|-----------|------|---|
| | | Min. | Typ. | Max. | | |
| "L" input voltage 1 | V _{IL1} | -0.3 | - | 0.2 × VCC | V | |
| "H" input voltage 1 | V _{IH1} | 0.8 × VCC | - | VCC+0.3 | V | |
| "L" output voltage 1 | V _{OL1} | 0 | - | 0.4 | V | I _{OL} =2.1mA, 4.0V ≤ VCC ≤ 5.5V |
| "L" output voltage 2 | V _{OL2} | 0 | - | 0.2 | V | I _{OL} =100μA |
| "H" output voltage 1 | V _{OH1} | 2.4 | - | VCC | V | I _{OH} =-0.4mA, 4.0V ≤ VCC ≤ 5.5V |
| "H" output voltage 2 | V _{OH2} | VCC-0.2 | - | VCC | V | I _{OH} =-100μA |
| Input leak current | I _{LI} | -1 | - | +1 | μA | V _{IN} =0V~VCC |
| Output leak current | I _{LO} | -1 | - | +1 | μA | V _{OUT} =0V~VCC, CS=0V |
| Current consumption at action | I _{CC1} | - | - | 3.0 | mA | f _{SK} =2MHz, t _{EW} =5ms (WRITE) |
| | I _{CC2} | - | - | 1.5 | mA | f _{SK} =2MHz (READ) |
| Standby current | I _{SB} | - | - | 2 | μA | CS=0V, DO=OPEN |

©Radiation resistance design is not made.

●Action timing characteristics

(Ta=-40~+85°C, VCC=2.5~5.5V)

| Parameter | Symbol | 2.5V ≤ VCC ≤ 5.5V | | | Unit |
|--------------------------------------|------------------|-------------------|------|------|------|
| | | Min. | Typ. | Max. | |
| SK frequency | f _{SK} | - | - | 2 | MHz |
| SK "H" time | t _{SKH} | 230 | - | - | ns |
| SK "L" time | t _{SKL} | 230 | - | - | ns |
| CS "L" time | t _{CS} | 200 | - | - | ns |
| CS setup time | t _{CSS} | 200 | - | - | ns |
| DI setup time | t _{DIS} | 100 | - | - | ns |
| CS hold time | t _{CSH} | 0 | - | - | ns |
| DI hold time | t _{DIH} | 100 | - | - | ns |
| Data "1" output delay time | t _{PD1} | - | - | 200 | ns |
| Data "0" output delay time | t _{PD0} | - | - | 200 | ns |
| Time from CS to output establishment | t _{SV} | - | - | 150 | ns |
| Time from CS to High-Z | t _{DF} | - | - | 150 | ns |
| Write cycle time | t _{EW} | - | - | 5 | ms |

(Ta=-40~+85°C, VCC=1.7~2.5V)

| Parameter | Symbol | 1.7V ≤ VCC ≤ 2.5V | | | Unit |
|--------------------------------------|------------------|-------------------|------|------|------|
| | | Min. | Typ. | Max. | |
| SK frequency | f _{SK} | - | - | 500 | kHz |
| SK "H" time | t _{SKH} | 0.8 | - | - | us |
| SK "L" time | t _{SKL} | 0.8 | - | - | us |
| CS "L" time | t _{CS} | 1 | - | - | us |
| CS setup time | t _{CSS} | 200 | - | - | ns |
| DI setup time | t _{DIS} | 100 | - | - | ns |
| CS hold time | t _{CSH} | 0 | - | - | ns |
| DI hold time | t _{DIH} | 100 | - | - | ns |
| Data "1" output delay time | t _{PD1} | - | - | 0.7 | us |
| Data "0" output delay time | t _{PD0} | - | - | 0.7 | us |
| Time from CS to output establishment | t _{SV} | - | - | 0.7 | us |
| Time from CS to High-Z | t _{DF} | - | - | 200 | ns |
| Write cycle time | t _{EW} | - | - | 5 | ms |

●Sync data input / output timing

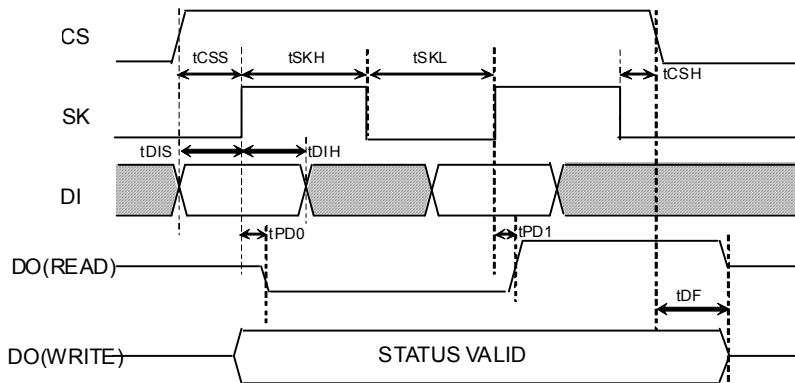

Fig.1 Sync data input / output timing

○Data is taken by DI sync with the rise of SK.

○At read action, data is output from DO in sync with the rise of SK.

○The status signal at write (READY / BUSY) is output after t_{CS} from the fall of CS after write command input, at the area DO where CS is "H", and valid until the next command start bit is input. And, while CS is "L", DO becomes High-Z.

○After completion of each mode execution, set CS "L" once for internal circuit reset, and execute the following action mode.

●BU9891GUL-W Characteristic data (The following characteristic data are Typ. values.)

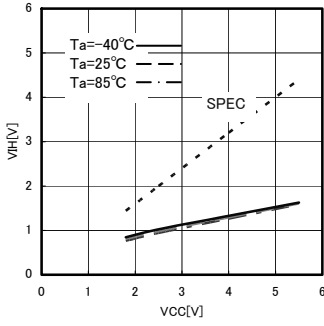

Fig.2 H input voltage VIL(CS,SK,DI)

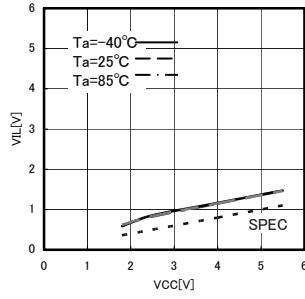

Fig.3 L input voltage VIL(CS,SK,DI)

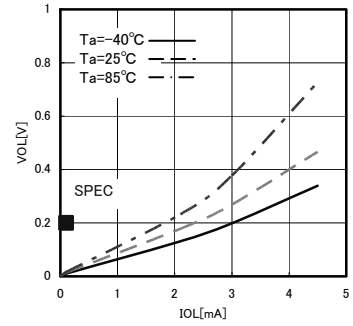

Fig.4 L output voltage VOL-IOL(VCC=1.8V)

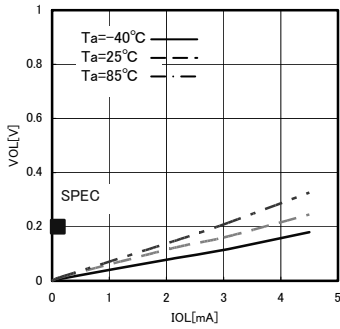

Fig.5 L output voltage VOL-IOL(VCC=2.5V)

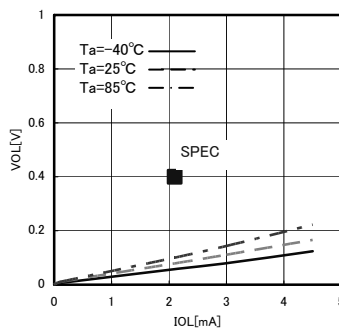

Fig.6 L output voltage VOL-IOL(VCC=4.0V)

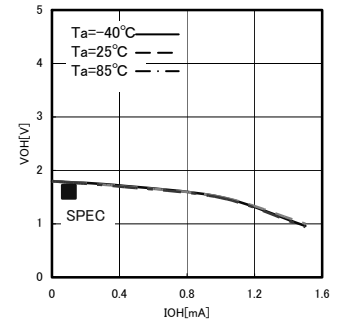

Fig.7 H output voltage VOH-IOH(VCC=1.8V)

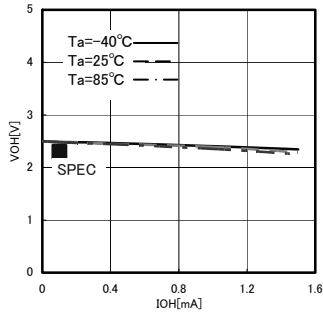

Fig.8 H output voltage VOH-IOH(VCC=2.5V)

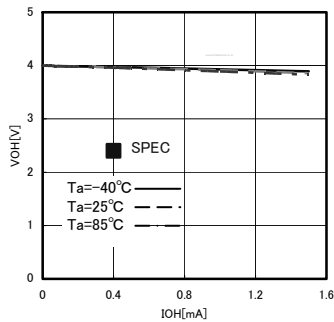

Fig.9 H output voltage VOH-IOH(VCC=4.0V)

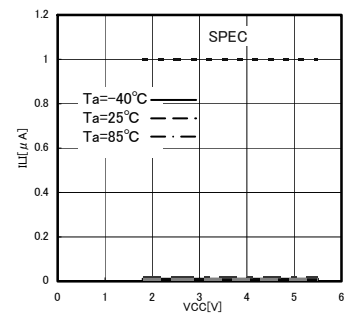

Fig.10 Input leak current ILI(CS,SK,DI)

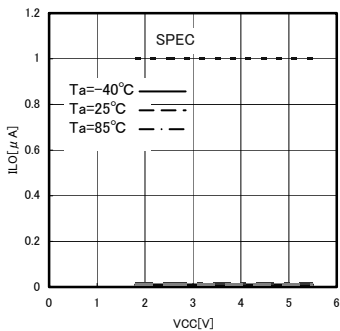

Fig.11 Output leak current ILO(DO)

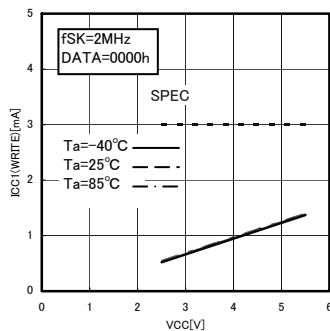

Fig.12 Current consumption at WRITE action ICC1(WRITE, fSK=2MHz)

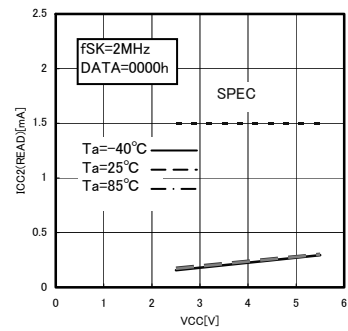

Fig.13 Consumption current at READ action ICC2(READ, fSK=2MHz)

● BU9891GUL-W Characteristic data (The following characteristic data are Typ. values.)

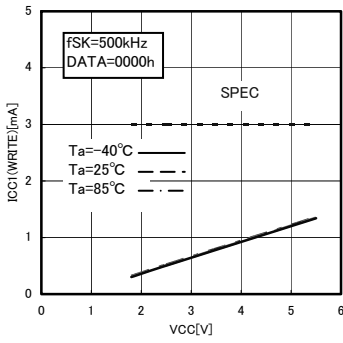

Fig.14 Current consumption at WRITE action

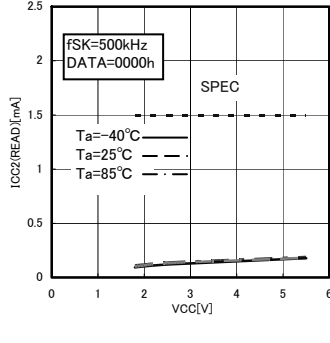

Fig.15 Consumption current at READ action ICC2 (READ, fSK=500kHz)

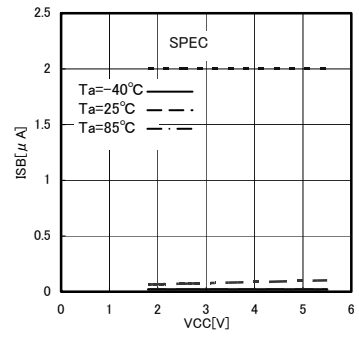

Fig.16 Consumption current at standby action ISB

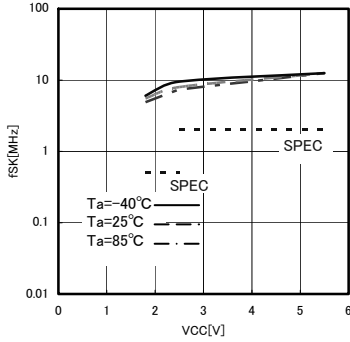

Fig.17 SK frequency fSK

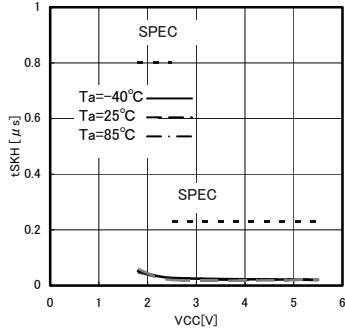

Fig.18 SK high time tSKH

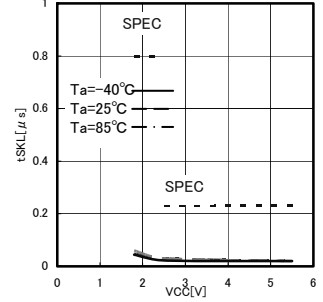

Fig.19 SK low time tSKL

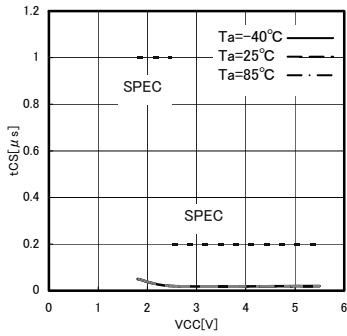

Fig.20 CS low time tCS

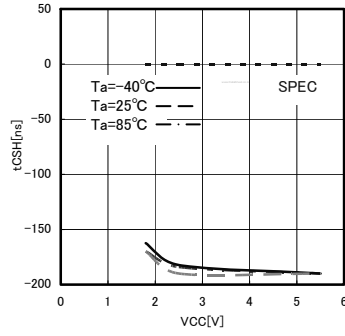

Fig.21 CS hold time tCSH

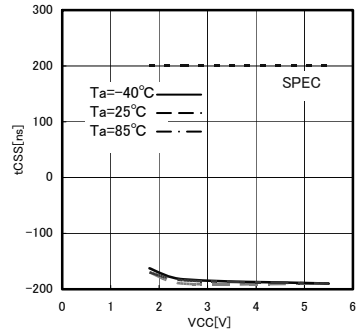

Fig.22 CS setup time tCSS

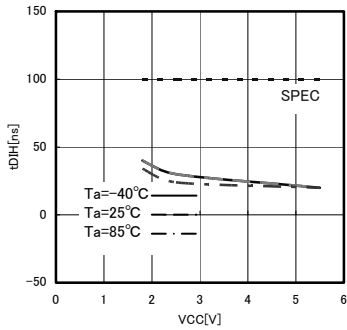

Fig.23 DI hold time tDIH

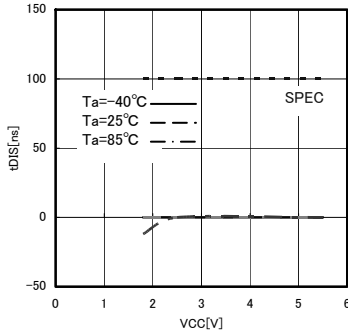

Fig.24 DI setup time tDIS

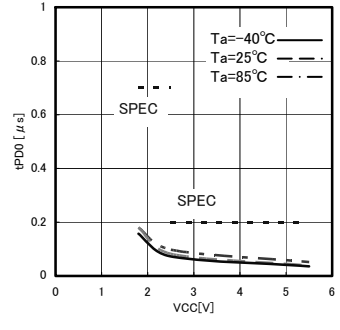

Fig.25 Data "0" output delay time tPD0

●BU9891GUL-W Characteristic data (The following characteristic data are Typ. values.)

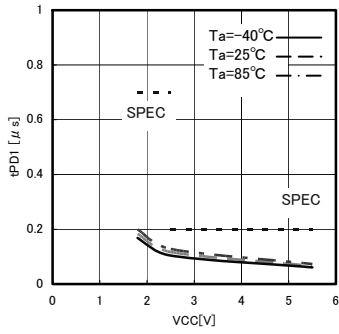

Fig.26 Output data "1" delay time tPD1

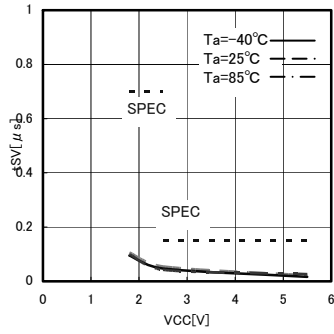

Fig.27 Time from CS to output establishment tSV

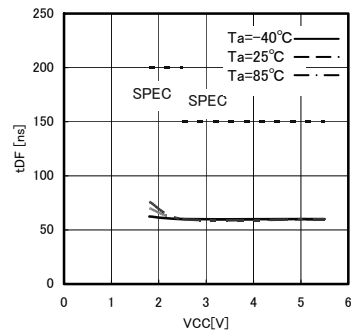

Fig.28 Time from CS to High-Z tDF

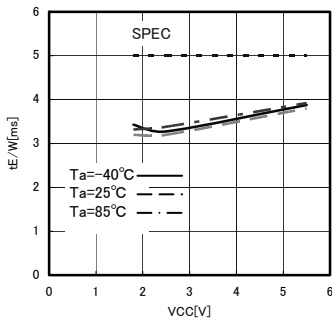

Fig.29 Write cycle time tE/W

●Block diagram

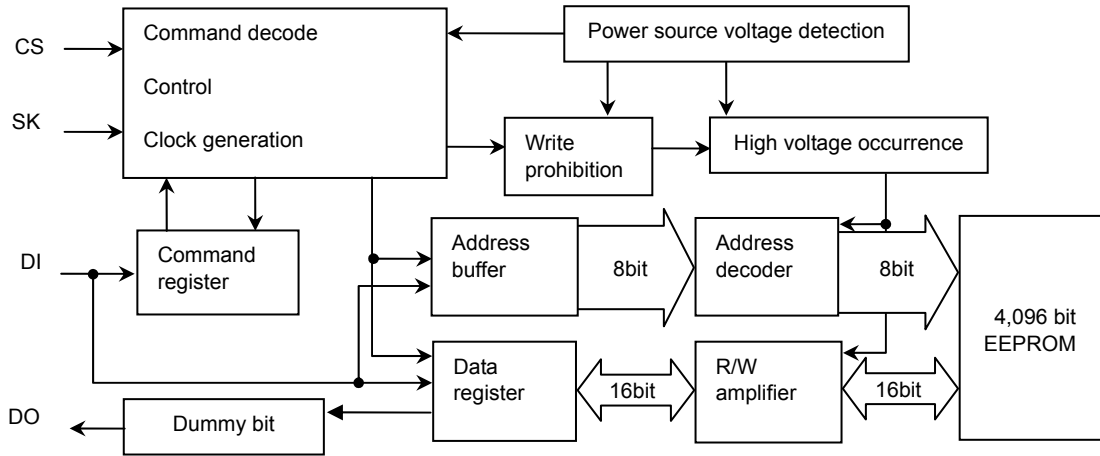

Fig.30 Block diagram

●Pin assignment and function

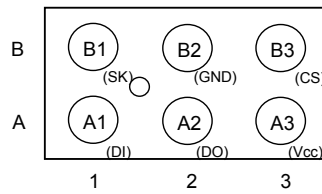

Fig.31 Pin assignment diagram

| Land No. | Pin Name | I / O | Function |
|----------|----------|--------|--|
| A1 | DI | INPUT | Start Bit, Op.code, Address, Serial Data Input |
| A2 | DO | OUTPUT | Serial Data Output, Ready/Busy Status Output |
| A3 | Vcc | - | Power Supply |
| B1 | SK | INPUT | Serial Data Clock Input |
| B2 | GND | - | Grand (0V) |
| B3 | CS | INPUT | Chip Select |

●Description of operations

Communications of the Microwire Bus are carried out by SK (serial clock), DI (serial data input),DO (serial data output) ,and CS (chip select) for device selection.

When to connect one EEPROM to a microcontroller, connect it as shown in Fig.32(a) or Fig.32(b). When to use the input and output common I/O port of the microcontroller, connect DI and DO via a resistor as shown in Fig.32(b), and connection by 3 lines is available.

In the case of plural connections, refer to Fig. 32 (c).

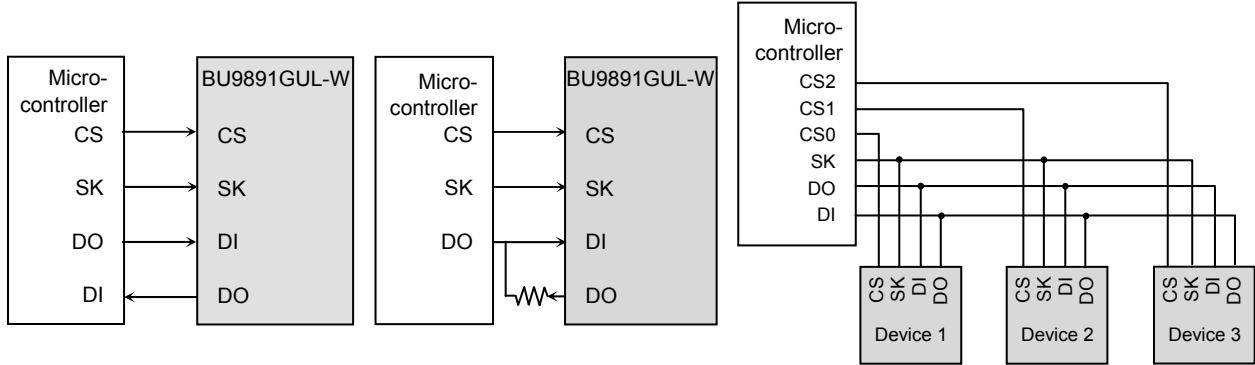

Fig.32-(a) Connection by 4 lines

Fig.32-(b) Connection by 3 lines

Fig.32-(c) Connection example of plural devices

Fig.32 Connection method with microcontroller

Communications of the Microwire Bus are started by the first “1” input after the rise of CS. This input is called a start bit. After input of the start bit, inputs ope code, address and data. Address and data are input all in MSB first manners.

“0” input after the rise of CS to the start bit input is all ignored. Therefore, when there is limitation in the bit width of PIO of the microcontroller, input “0” before the start bit input, to control the bit width.

●Command mode

| Command | Start bit | Ope code | Address | Data |
|-----------------------------|-----------|----------|-------------------------|--------------------|
| Read (READ) ^{*1} | 1 | 10 | A7,A6,A5,A4,A3,A2,A1,A0 | D15~D0(READ DATA) |
| Write enable (WEN) | 1 | 00 | 1 1 * * * * * * | |
| Write (WRITE) ^{*2} | 1 | 01 | A7,A6,A5,A4,A3,A2,A1,A0 | D15~D0(WRITE DATA) |
| Write disable (WDS) | 1 | 00 | 0 0 * * * * * * | |

- Input the address and the data in MSB first manners.
- As for *, input either VIH or VIL.

*Start bit

Acceptance of all the commands of this IC starts at recognition of the start bit.
The start bit means the first “1” input after the rise of CS.

*1 As for read, by continuous SK clock input after setting the read command, data output of the set address starts, and address data in significant order are sequentially output continuously. (Auto increment function)

*2 When the read and the write all commands are executed, data written in the selected memory cell is automatically deleted, and input data is written.

●Timing chart

1) Read cycle (READ)

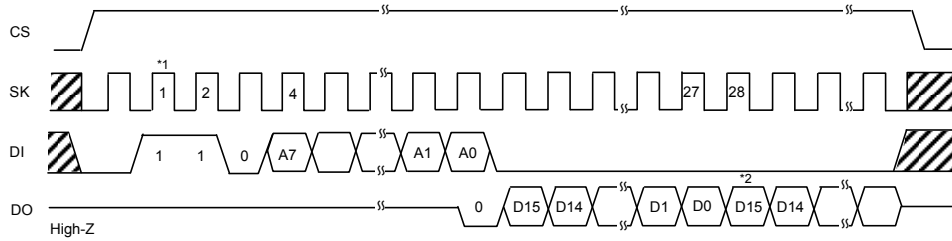

*1 Start bit

When data "1" is input for the first time after the rise of CS, this is recognized as a start bit. And when "1" is input after plural "0" are input, it is recognized as a start bit, and the following operation is started. This is common to all the commands to be described hereafter.

Fig. 33 Read cycle

○When the read command is recognized, input address data (16bit) is output to serial. And at that moment, at taking A0, in sync with the rise of SK, "0" (dummy bit) is output. And, the following data is output in sync with the rise of SK. This IC has an address auto increment function valid only at read command. This is the function where after the above read execution, by continuously inputting SK clock, the above address data is read sequentially. And, during the auto increment, keep CS at "H".

2) Write cycle (WRITE)

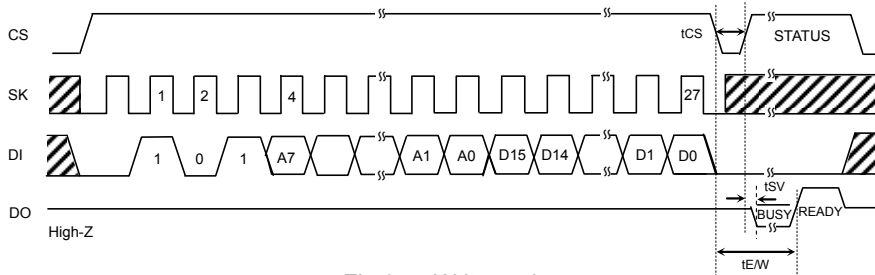

Fig.34 Write cycle

○In this command, input 16bit data (D15~D0) are written to designated addresses (Am~A0). The actual write starts by the fall of CS of D0 taken SK clock. When STATUS is not detected, (CS="L" fixed) Max. 5ms in conformity with tE/W, and when STATUS is detected (CS="H"), all commands are not accepted for areas where "L" (BUSY) is output from D0, therefore, do not input any command.

3) Write enable (WEN) / disable (WDS) cycle

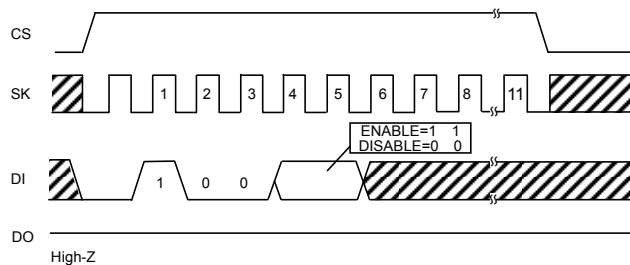

Fig.35 Write enable (WEN) / disable (WDS) cycle

○At power on, this IC is in write disable status by the internal RESET circuit. Before executing the write command, it is necessary to execute the write enable command. And, once this command is executed, it is valid until the write disable command is executed or the power is turned off. However, the read command is valid irrespective of write enable / disable command. Input to SK after 6 clocks of this command is available by either "H" or "L", but be sure to input it.
 ○When the write enable command is executed after power on, write enable status gets in. When the write disable command is executed thereafter in software manner, the IC gets in write disable status as same as at power on, and then the write command is canceled thereafter in software manner. However, the read command is executable. In write enable status, even when the write command is input by mistake, write is started. To prevent such a mistake, it is recommended to execute the write disable command after completion of write.

●Application

1) Method to cancel each command

○READ

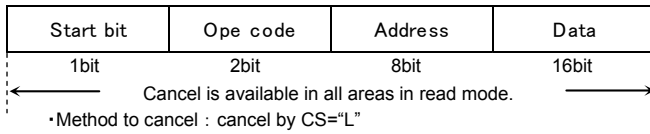
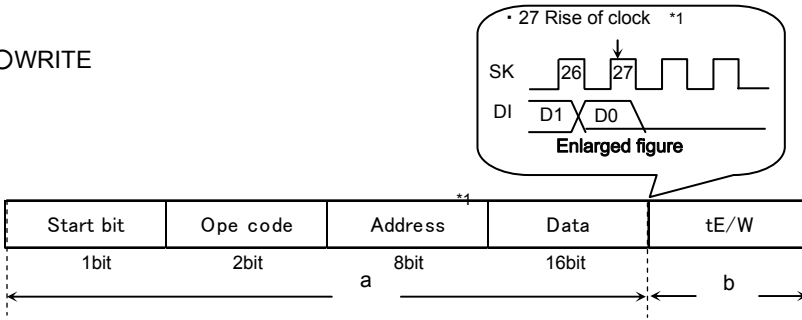

Fig.36 READ cancel available timing

○WRITE



a : From start bit to 27 clock rise*1
 Cancel by CS="L"

b : 27 clock rise and after*1
 Cancellation is not available by any means. If Vcc is made OFF in this area, designated address data is not guaranteed, therefore write once again.
 And when SK clock is input continuously, cancellation is not available.

Note 1) If Vcc is made OFF in this area, designated address data is not guaranteed, therefore write once again.

Note 2) If CS is started at the same timing as that of the SK rise, write execution/cancel becomes unstable, therefore, it is recommended to fail in SK="L" area.
 As for SK rise, necessary timing of tCSS/tCSH or higher.

Fig.37 WRITE cancel available timing

2) At standby

○Standby current

When CS is "L", SK input is "L", DI input is "H", and even with middle electric potential, current does not increase.

○Timing

As shown in Fig.38, when SK at standby is "H", if CS is started, DI status may be read at the rise edge. At standby and at power ON/OFF, when to start CS, set SK input or DI input to "L" status.

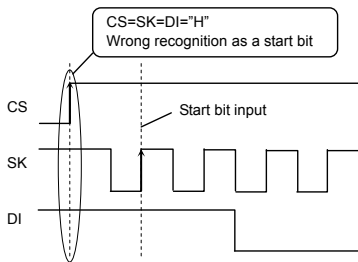

Fig.38 Wrong action timing

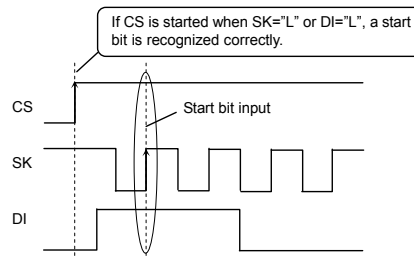

Fig.39 Normal action timing

3)Equivalent circuit

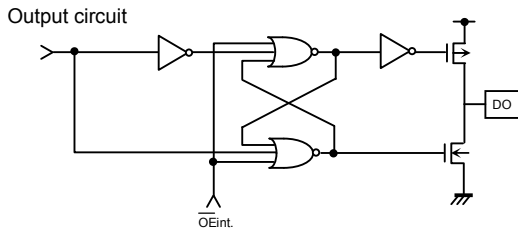

Fig.40 Output circuit (DO)

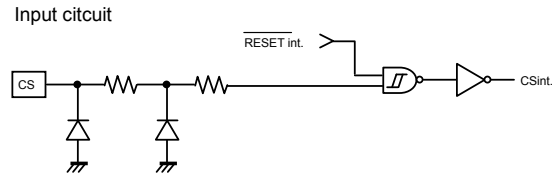

Fig.41 Input circuit (CS)

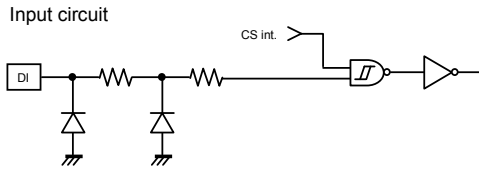

Fig.42 Input circuit (DI)

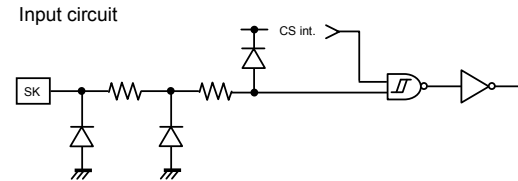

Fig.43 Input circuit (SK)

4) I/O peripheral circuit

4-1) Pull down CS.

By making CS="L" at power ON/OFF, mistake in operation and mistake write are prevented.

○ Pull down resistance Rpd of CS pin

To prevent mistake in operation and mistake write at power ON/OFF, CS pull down resistance is necessary. Select an appropriate value to this resistance value from microcontroller VOH, IOH, and VIL characteristics of this IC.

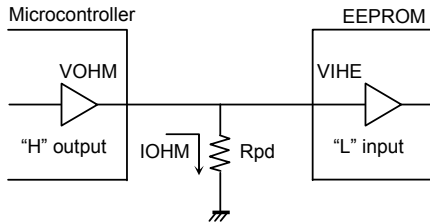

Fig.44 CS pull down resistance

$$R_{pd} \geq \frac{VO_{HM}}{IO_{HM}} \quad \dots \textcircled{1}$$

$$VO_{HM} \geq VI_{HE} \quad \dots \textcircled{2}$$

Example) When $V_{CC} = 5V$, $VI_{HE} = 2V$, $VO_{HM} = 2.4V$, $IO_{HM} = 2mA$, from the equation ①,

$$R_{pd} \geq \frac{2.4}{2 \times 10^{-3}}$$

$$\therefore R_{pd} \geq 1.2 [k\Omega]$$

With the value of Rpd to satisfy the above equation, VOHM becomes 2.4V or higher, and VIHE (=2.0V), the equation ② is also satisfied.

- VIHE : EEPROM VIH specifications
- VOHM : Microcontroller VOH specifications
- IOHM : Microcontroller IOH specifications

4-2) DO is available in both pull up and pull down.

Do output become "High-Z" in other READY / BUSY output timing than after data output at read command and write command. When malfunction occurs at "High-Z" input of the microcontroller port connected to DO, it is necessary to pull down and pull up DO. When there is no influence upon the microcontroller actions, DO may be OPEN.

If DO is OPEN, and at timing to output status READY, at timing of CS="H", SK="H", DI="H", EEPROM recognizes this as a start bit, resets READY output, and DO="High-Z", therefore, READY signal cannot be detected. To avoid such output, pull up DO pin for improvement.

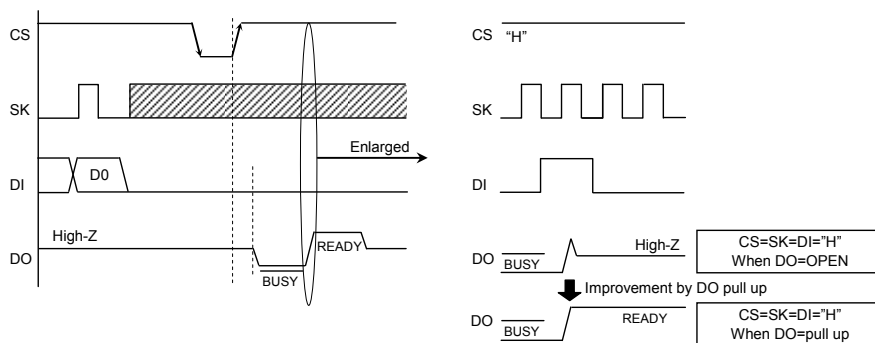

Fig.45 READY output timing at DO=OPEN

○ Pull up resistance R_{pu} and pull down resistance R_{pd} of DO pin

As for pull up and pull down resistance value, select an appropriate value to this resistance value from microcontroller V_{IH} , V_{IL} , and V_{OH} , I_{OH} , V_{OL} , I_{OL} characteristics of this IC.

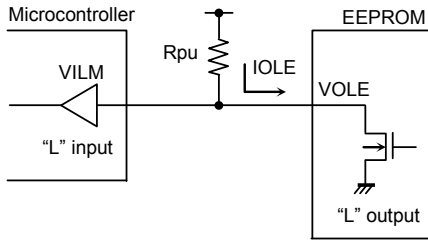

Fig.46 DO pull up resistance

$$R_{pu} \geq \frac{V_{CC} - V_{OLE}}{I_{OLE}} \dots \textcircled{3}$$

$$V_{OLE} \leq V_{ILM} \dots \textcircled{4}$$

Example) When $V_{CC} = 5V$, $V_{OLE} = 0.4V$, $I_{OLE} = 2.1mA$, $V_{ILM} = 0.8V$, from the equation $\textcircled{3}$,

$$R_{pu} \geq \frac{5 - 0.4}{2.1 \times 10^{-3}}$$

$$\therefore R_{pu} \geq 2.2 [k\Omega]$$

With the value of R_{pu} to satisfy the above equation, V_{OLE} becomes 0.4V or below, and with $V_{ILM} (= 0.8V)$, the equation $\textcircled{4}$ is also satisfied.

- V_{OLE} : EEPROM V_{OL} specifications
- I_{OLE} : EEPROM I_{OL} specifications
- V_{ILM} : Microcontroller V_{IL} specifications

$$R_{pd} \geq \frac{V_{OHE}}{I_{OHE}} \dots \textcircled{5}$$

$$V_{OHE} \geq V_{IHM} \dots \textcircled{6}$$

Example) When $V_{CC} = 5V$, $V_{OHE} = V_{CC} - 0.2V$, $I_{OHE} = 0.1mA$, $V_{IHM} = V_{CC} \times 0.7V$ from the equation $\textcircled{5}$,

$$R_{pd} \geq \frac{5 - 0.2}{0.1 \times 10^{-3}}$$

$$\therefore R_{pd} \geq 48 [k\Omega]$$

With the value of R_{pd} to satisfy the above equation, V_{OHE} becomes 2.4V or below, and with $V_{IHM} (= 3.5V)$, the equation $\textcircled{6}$ is also satisfied.

- V_{OHE} : EEPROM V_{OH} specifications
- I_{OHE} : EEPROM I_{OH} specifications
- V_{IHM} : Microcontroller V_{IH} specifications

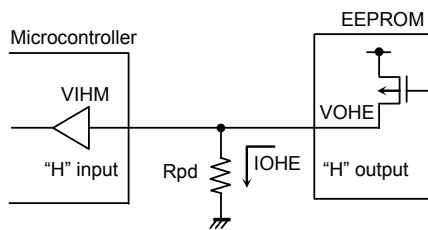

Fig.47 DO pull down resistance

5) \overline{READY} / \overline{BUSY} status display (DO terminal)

This display outputs the internal status signal. When CS is started after t_{CS} (Min.200ns) from CS fall after write command input, "H" or "L" is output.

R/\overline{B} display = "L" (\overline{BUSY}) = write under execution

(DO status) After the timer circuit in the IC works and creates the period of $t_{E/W}$, this time circuit completes automatically. And write to the memory cell is made in the period of $t_{E/W}$, and during this period, other command is not accepted.

R/\overline{B} display = "H" (READY) = command wait status

(DO status) Even after $t_{E/W}$ (max.5ms) from write of the memory cell, the following command is accepted. Therefore, CS="H" in the period of $t_{E/W}$, and when input is in SK, DI, malfunction may occur, therefore, DI="L" in the area CS="H". (Especially, in the case of shared input port, attention is required.)

*Do not input any command while status signal is output. Command input in \overline{BUSY} area is cancelled, but command input in READY area is accepted. Therefore, status READY output is cancelled, and malfunction and mistake write may be made.

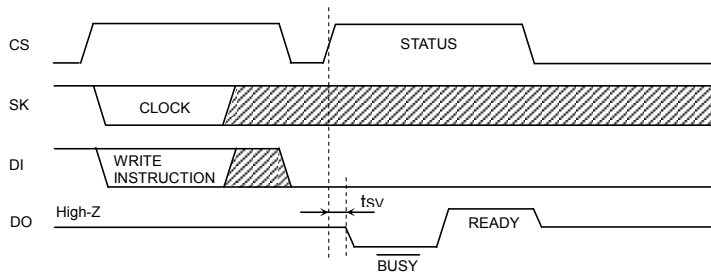

Fig.48 R/\overline{B} status output timing chart

6) When to directly connect DI and DO

This IC has independent input terminal DI and output terminal DO, and separate signals are handled on timing chart, meanwhile, by inserting a resistance R between these DI and DO terminals, it is possible to carry out control by 1 control line.

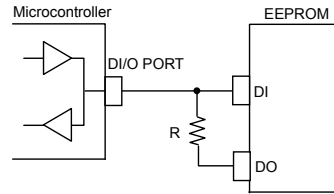

Fig.49 DI, DO control line common connection

○Data collision of microcontroller DI/O output and DO output and feedback of DO output to DI input.

Drive from the microcontroller DI/O output to DI input on I/O timing, and signal output from DO output occur at the same time in the following points.

- (1) 1 clock cycle to take in A0 address data at read command

Dummy bit "0" is output to DO terminal.

→When address data A0 = "1" input, through current route occurs.

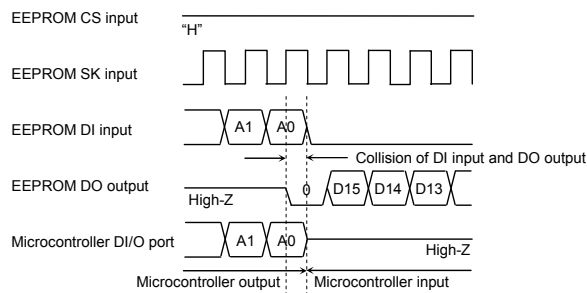

Fig.50 Collision timing at read data output at DI, DO direct connection

- (2) Timing of CS = "H" after write command. DO terminal in READY / $\overline{\text{BUSY}}$ function output.

When the next start bit input is recognized, "HIGH-Z" gets in.

→Especially, at command input after write, when CS input is started with microcontroller DI/O output "L", READY output "H" is output from DO terminal, and through current route occurs.

Feedback input at timing of these (1) and (2) does not cause disorder in basic operations, if resistance R is inserted.

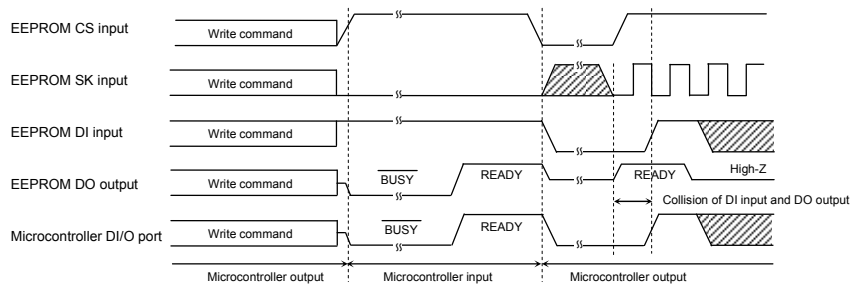

Fig.51 Collision timing at DI, DO direct connection

Note) As for the case (2), attention must be paid to the following.

When status READY is output, DO and DI are shared, DI="H" and the microcontroller DI/O="High-Z" or the microcontroller DI/O="H", if SK clock is input, DO output is input to DI and is recognized as a start bit, and malfunction may occur. As a method to avoid malfunction, at status READY output, set SK="L", or start CS within 4 clocks after "H" of READY signal is output.

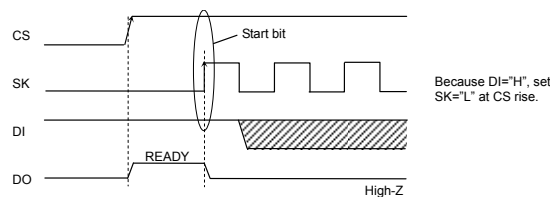
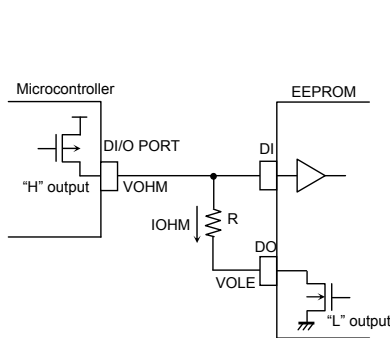

Fig.52 Start bit input timing at DI, DO direct connection

○ Selection of resistance value R

The resistance R becomes through current limit resistance at data collision. When through current flows, noises of power source line and instantaneous stop of power source may occur. When allowable through current is defined as I, the following relation should be satisfied. Determine allowable current amount in consideration of impedance and so forth of power source line in set. And insert resistance R, and set the value R to satisfy EEPROM input level VIH/VIL even under influence of voltage decline owing to leak current and so forth. Insertion of R will not cause any influence upon basic operations.

- (1) Address data A0 = "1" input, dummy bit "0" output timing
 (When microcontroller DI/O output is "H", EEPROM DO outputs "L", and "H" is input to DI)
- Make the through current to EEPROM 10mA or below.
 - See to it that the level VIH of EEPROM should satisfy the following.



Conditions

$$VOHM \leq VIHE$$

$$VOHM \leq IOHM \times R + VOLE$$

At this moment, if $VOLE=0V$,

$$VOHM \leq IOHM \times R$$

$$\therefore R \geq \frac{VOHM}{IOHM} \dots \textcircled{7}$$

- VIHE : EEPROM VIH specifications
- VOLE : EEPROM VOL specifications
- VOHM : Microcontroller VOH specifications
- IOHM : Microcontroller IOH specifications

Fig. 53 Circuit at DI, DO direct connection (Microcontroller DI/O "H" output, EEPROM "L" output)

- (2) DO status READY output timing
 (When the microcontroller DI/O is "L", EEPROM DO output "H", and "L" is input to DI)
- Set the EEPROM input level VIL so as to satisfy the following.

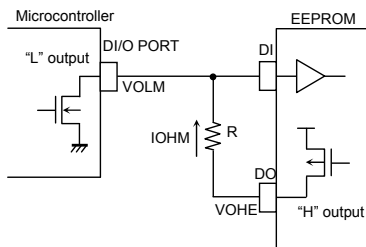

Conditions

$$VOLM \geq VILE$$

$$VOLM \geq VOHE - IOLM \times R$$

As this moment, $VOHE=Vcc$

$$VOLM \geq Vcc - IOLM \times R$$

$$\therefore R \geq \frac{Vcc - VOLM}{IOLM} \dots \textcircled{8}$$

- VILE : EEPROM VIL specifications
- VOHE : EEPROM VOH specifications
- VOLM : Microcontroller VOL specifications
- IOLM : Microcontroller IOL specifications

Example) When $Vcc=5V$, $VOHM=5V$, $IOHM=0.4mA$, $VOLM=5V$, $IOLM=0.4mA$,

From the equation $\textcircled{7}$,

$$R \geq \frac{VOHM}{IOHM}$$

$$R \geq \frac{5}{0.4 \times 10^{-3}}$$

$$\therefore R \geq 12.5 \text{ [k}\Omega\text{]} \dots \textcircled{9}$$

From the equation $\textcircled{8}$,

$$R \geq \frac{Vcc - VOLM}{IOLM}$$

$$R \geq \frac{5 - 0.4}{2.1 \times 10^{-3}}$$

$$\therefore R \geq 2.2 \text{ [k}\Omega\text{]} \dots \textcircled{10}$$

Therefore, from the equations $\textcircled{9}$ and $\textcircled{10}$,

$$\therefore R \geq 12.5 \text{ [k}\Omega\text{]}$$

Fig. 54 Circuit at DI, DO direct connection (Microcontroller DI/O "L" output, EEPROM "H" output)

7)Notes on power ON/OFF

- At power ON/OFF, set CS "L".

When CS is "H", this IC gets in input accept status (active). If power is turned on in this status, noises and the likes may cause malfunction, mistake write or so. To prevent these, at power ON, set CS "L". (When CS is in "L" status, all inputs are cancelled.) And at power decline, owing to power line capacity and so forth, low power status may continue long. At this case too, owing to the same reason, malfunction, mistake write may occur, therefore, at power OFF too, set CS "L".

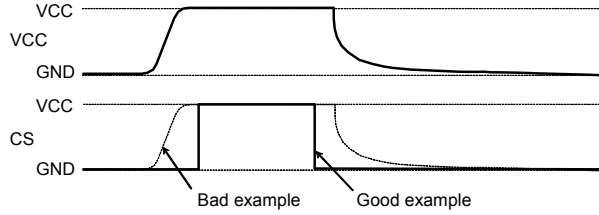

Fig.55 Timing at power ON/OFF

(Bad example)CS pin is pulled up to Vcc.

In this case, CS becomes "H" (active status), and EEPROM may have malfunction, mistake write owing to noise and the likes. Even when CS input is High-Z, the status becomes like this case, which please note.

(Good example)It is "L" at power ON/OFF.

Set 10ms or higher to recharge at power OFF. When power is turned on without observing this condition, IC internal circuit may not be reset, which please note.

OPOR circuit

This IC has a POR (Power On Reset) circuit as a mistake write countermeasure. After POR action, it gets in write disable status. The POR circuit is valid only when power is ON, and does not work when power is OFF. However, if CS is "H" at power ON/OFF, it may become write enable status owing to noises and the likes. For secure actions, observe the following conditions.

- Set CS="L"
- Turn on power so as to satisfy the recommended conditions of t_R , t_{OFF} , V_{bot} for POR circuit action.

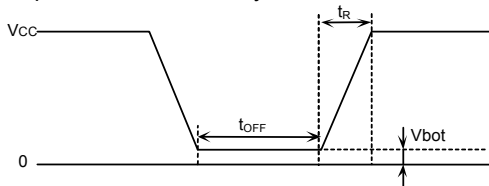

Recommended conditions of t_R , t_{OFF} , V_{bot}

| t_R | t_{OFF} | V_{bot} |
|----------------|----------------|---------------|
| 10ms or below | 10ms or higher | 0.3V or below |
| 100ms or below | 10ms or higher | 0.2V or below |

Fig.56 Rise waveform diagram

OLVCC circuit

LVCC (VCC-Lockout) circuit prevents data rewrite action at low power, and prevents wrong write. At LVCC voltage (Typ.=1.2V) or below, it prevent data rewrite.

8)Noise countermeasures

OVCC noise (bypass capacitor)

When noise or surge gets in the power source line, malfunction may occur, therefore, for removing these, it is recommended to attach a by pass capacitor (0.1 μF) between IC VCC and GND, At that moment, attach it as close to IC as possible.And, it is also recommended to attach a bypass capacitor between board VCC and GND.

OSK noise

When the rise time (t_R) of SK is long, and a certain degree or more of noise exists, malfunction may occur owing to clock bit displacement. To avoid this, a Schmitt trigger circuit is built in SK input. The hysteresis width of this circuit is set about 0.2V, if noises exist at SK input, set the noise amplitude 0.2Vp-p or below. And it is recommended to set the rise time (t_R) of SK 100ns or below. In the case when the rise time is 100ns or higher, take sufficient noise countermeasures. Make the clock rise, fall time as small as possible.

●Notes for use

- (1) Described numeric values and data are design representative values, and the values are not guaranteed.
- (2) We believe that application circuit examples are recommendable, however, in actual use, confirm characteristics further sufficiently. In the case of use by changing the fixed number of external parts, make your decision with sufficient margin in consideration of static characteristics and transition characteristics and fluctuations of external parts and our LSI.
- (3) Absolute Maximum Ratings
If the absolute maximum ratings such as impressed voltage and action temperature range and so forth are exceeded, LSI may be destructed. Do not impress voltage and temperature exceeding the absolute maximum ratings. In the case of fear exceeding the absolute maximum ratings, take physical safety countermeasures such as fuses, and see to it that conditions exceeding the absolute maximum ratings should not be impressed to LSI.
- (4) GND electric potential
Set the voltage of GND terminal lowest at any action condition. Make sure that each terminal voltage is not lower than that of GND terminal in consideration of transition status.
- (5) Heat design
In consideration of allowable loss in actual use condition, carry out heat design with sufficient margin.
- (6) Terminal to terminal shortcircuit and wrong packaging
When to package LSI onto a board, pay sufficient attention to LSI direction and displacement. Wrong packaging may destruct LSI. And in the case of shortcircuit between LSI terminals and terminals and power source, terminal and GND owing to foreign matter, LSI may be destructed.
- (7) Use in a strong electromagnetic field may cause malfunction, therefore, evaluate design sufficiently

●Ordering part number

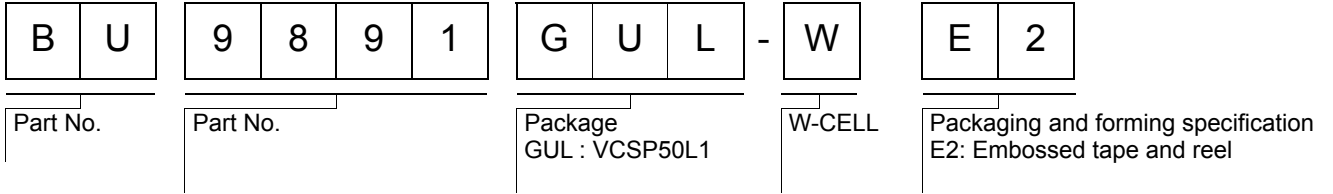

VCSP50L1(BU9891GUL-W)

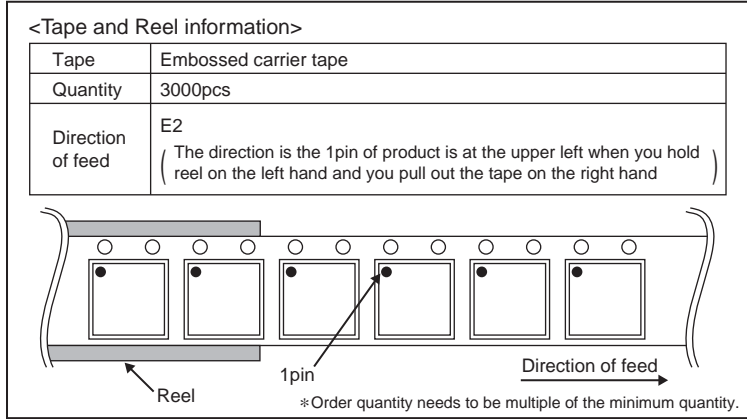
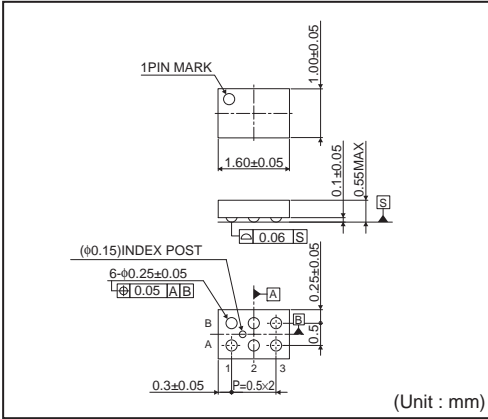

Notes

No copying or reproduction of this document, in part or in whole, is permitted without the consent of ROHM Co.,Ltd.

The content specified herein is subject to change for improvement without notice.

The content specified herein is for the purpose of introducing ROHM's products (hereinafter "Products"). If you wish to use any such Product, please be sure to refer to the specifications, which can be obtained from ROHM upon request.

Examples of application circuits, circuit constants and any other information contained herein illustrate the standard usage and operations of the Products. The peripheral conditions must be taken into account when designing circuits for mass production.

Great care was taken in ensuring the accuracy of the information specified in this document. However, should you incur any damage arising from any inaccuracy or misprint of such information, ROHM shall bear no responsibility for such damage.

The technical information specified herein is intended only to show the typical functions of and examples of application circuits for the Products. ROHM does not grant you, explicitly or implicitly, any license to use or exercise intellectual property or other rights held by ROHM and other parties. ROHM shall bear no responsibility whatsoever for any dispute arising from the use of such technical information.

The Products specified in this document are intended to be used with general-use electronic equipment or devices (such as audio visual equipment, office-automation equipment, communication devices, electronic appliances and amusement devices).

The Products specified in this document are not designed to be radiation tolerant.

While ROHM always makes efforts to enhance the quality and reliability of its Products, a Product may fail or malfunction for a variety of reasons.

Please be sure to implement in your equipment using the Products safety measures to guard against the possibility of physical injury, fire or any other damage caused in the event of the failure of any Product, such as derating, redundancy, fire control and fail-safe designs. ROHM shall bear no responsibility whatsoever for your use of any Product outside of the prescribed scope or not in accordance with the instruction manual.

The Products are not designed or manufactured to be used with any equipment, device or system which requires an extremely high level of reliability the failure or malfunction of which may result in a direct threat to human life or create a risk of human injury (such as a medical instrument, transportation equipment, aerospace machinery, nuclear-reactor controller, fuel-controller or other safety device). ROHM shall bear no responsibility in any way for use of any of the Products for the above special purposes. If a Product is intended to be used for any such special purpose, please contact a ROHM sales representative before purchasing.

If you intend to export or ship overseas any Product or technology specified herein that may be controlled under the Foreign Exchange and the Foreign Trade Law, you will be required to obtain a license or permit under the Law.



Thank you for your accessing to ROHM product informations.
More detail product informations and catalogs are available, please contact us.

ROHM Customer Support System

<http://www.rohm.com/contact/>