

# INTERNATIONAL RECTIFIER

## 1N3879, 1N3889, 6FL, 12FL, 16FL SERIES

### 6A, 12A and 16A Fast Recovery Rectifiers

#### Major Ratings and Characteristics

	1N3879 -1N3883	1N3889 -1N3893	6FL...	12FL...	16FL...	Unit	
$I_F(AV)^{\dagger}$	6*	12*	6	12	16	A	
$I_{FSM}$	50Hz	72	145	110	145	180	A
	60Hz	75*	150*	115	150	190	A
$I^2t$	50Hz	26	103	60	103	160	A <sup>2</sup> s
	60Hz	23	94	55	94	150	A <sup>2</sup> s
$I_R$	363	1452	855	1452	2290	A $\sqrt{s}$	
$t_{rr}$ range	see table					ns	
$V_{RRM}$ range	50 - 400*		50 - 1000			V	
$T_J$ range	-65 to 150					°C	

\*JEDEC registered values.

$\dagger$  At max.  $T_C = 100^\circ\text{C}$ .

#### Description

This range of fast recovery diodes is designed for applications in DC power supplies, inverters, converters, choppers, ultrasonic systems and for use as free wheel diodes.

#### Features

- Short reverse recovery time
- Low stored charge
- Wide current range
- Excellent surge capabilities
- Standard JEDEC types
- Stud cathode and stud anode versions
- Types up to 1000V  $V_{RRM}$
- Fully characterised reverse recovery conditions

#### CASE STYLE AND DIMENSIONS

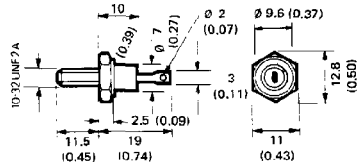
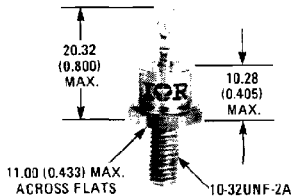

Conforms to JEDEC: DO-203AA (DO-4)  
 EIC 191-2, A3U  
 BS 3934: SO-10A  
 DIN 41885: 101 C 2

All dimensions in millimetres (inches)

REVERSE VOLTAGE RATINGS

Part Number ① ②	VRRM – Max. Repetitive Peak Reverse Voltage		VRRM – Max. Non-Repetitive Peak Reverse Voltage $t_p \leq 5\text{ms}$		IR – Max. Reverse Current At Rated VR		
	V		V		T <sub>J</sub> = 25°C	T <sub>J</sub> = 100°C	T <sub>J</sub> = 150°C
	mA		mA		mA	mA	mA
1N3879	50	75	0.015*	1.0*	3.0*		
1N3880	100	160	0.015*	1.0*	3.0*		
1N3881	200	250	0.015*	1.0*	3.0*		③
1N3882	300	350	0.015*	1.0*	3.0*		
1N3883	400	450	0.015*	1.0*	3.0*		
1N3890	50	75	0.025*	3.0*	5.0*		
1N3890	100	150	0.025*	3.0*	5.0*		
1N3891	200	250	0.025*	3.0*	5.0*		③
1N3892	300	350	0.025*	3.0*	5.0*		
1N3893	400	450	0.025*	3.0*	5.0*		
**6FL6S02	6FL6S05	6FL6S10	50	75	0.050	—	6.0
6FL10S02	6FL10S05	6FL10S10	100	150	0.050	—	6.0
6FL20S02	6FL20S05	6FL20S10	200	275	0.050	—	6.0
6FL40S02	6FL40S05	6FL40S10	400	500	0.050	—	6.0
6FL60S02	6FL60S05	6FL60S10	600	725	0.050	—	6.0
—	6FL80S05	6FL80S10	800	950	0.050	—	6.0
—	6FL100S05	6FL100S10	1000	1250	0.050	—	6.0
**12FL5S02	12FL5S05	12FL5S10	50	75	0.050	—	6.0
12FL10S02	12FL10S05	12FL10S10	100	150	0.050	—	6.0
12FL20S02	12FL20S05	12FL20S10	200	275	0.050	—	6.0
12FL40S02	12FL40S05	12FL40S10	400	500	0.050	—	6.0
12FL60S02	12FL60S05	12FL60S10	600	725	0.050	—	6.0
—	12FL80S05	12FL80S10	800	950	0.050	—	6.0
—	12FL100S05	12FL100S10	1000	1250	0.050	—	6.0
**16FL5S02	16FL5S05	16FL5S10	50	75	0.050	—	6.0
16FL10S02	16FL10S05	16FL10S10	100	150	0.050	—	6.0
16FL20S02	16FL20S05	16FL20S10	200	275	0.050	—	6.0
16FL40S02	16FL40S05	16FL40S10	400	500	0.050	—	6.0
16FL60S02	16FL60S05	16FL60S10	600	725	0.050	—	6.0
—	16FL80S05	16FL80S10	800	950	0.050	—	6.0
—	16FL100S05	16FL100S10	1000	1250	0.050	—	6.0

REVERSE RECOVERY CHARACTERISTICS

t <sub>rr</sub>	Max. reverse recovery time	1N3879–1N3883		6FL...			12FL...			16FL...			Unit	Conditions
		S02	S05	S10	S02	S05	S10	S02	S05	S10				
t <sub>rr</sub>	Max. reverse recovery time	150	150	110	285	490	100	250	430	90	225	390	ns	T <sub>J</sub> = 25°C, I <sub>F</sub> = 1A to V <sub>R</sub> = 30V dI <sub>F</sub> /dt = 100 A/μs
		300*	300*	200	500	1000	200	500	1000	200	500	1000	ns	T <sub>J</sub> = 25°C, dI <sub>F</sub> /dt = 25 A/μs
I <sub>RM(REC)</sub>	Max. peak reverse current	4*	5*	—	—	—	—	—	—	—	—	—	nA	I <sub>FM</sub> = π × rated I <sub>F</sub> (AV)
Q <sub>RR</sub>	Max. reverse recovered charge	400	350	230	1700	5000	200	1300	3800	150	1100	3000	nC	T <sub>J</sub> = 25°C, I <sub>F</sub> = 1A to V <sub>R</sub> = 30V dI <sub>F</sub> /dt = 100 A/μs
		400	400	200	1200	5000	200	1200	5000	200	1200	5000	nC	T <sub>J</sub> = 25°C, dI <sub>F</sub> /dt = 25 A/μs I <sub>FM</sub> = π × rated I <sub>F</sub> (AV)

ELECTRICAL SPECIFICATIONS

	1N3879–1N3883	6FL...	1N3889–1N3893	12FL...	16FL...	Unit	Conditions
<b>FORWARD CONDUCTION</b>							
I <sub>F(AV)</sub>	Max. average forward current	5*	6	12*	16	A	180° conduction, half sine wave, T <sub>C</sub> = 100°C
I <sub>F(RMS)</sub>	Max. r.m.s. forward current	9.5	9.5	19	25	A	
I <sub>FSM</sub>	Max. peak one-cycle non-repetitive forward current	72	110	145	180	A	t = 10 ms With rated V <sub>RRM</sub>
		75*	115	150*	190		t = 8.3 ms
		95	130	170	215		t = 10 ms V <sub>RRM</sub> = 0
		90	135	180	225		t = 8.3 ms
i <sub>2t</sub>	Max. i <sub>2t</sub> for fusing	26	60	103	160	A <sup>2</sup>	t = 10 ms With rated V <sub>RRM</sub>
		22	55	94	150		t = 8.3 ms
		36	86	145	230		t = 10 ms V <sub>RRM</sub> = 0
		33	78	130	210		t = 8.3 ms
i <sub>2√t</sub>	Max. i <sub>2√t</sub> for individual device fusing ①	363	856	1452	220	i <sub>2√s</sub>	t = 0.1 to 10 ms
V <sub>FM</sub>	Max. peak forward voltage	1.4*	1.4	1.4*	1.4	V	T <sub>J</sub> = 25°C, I <sub>F</sub> = rated I <sub>F</sub> (AV) (D.C.)
		1.5*	1.5	1.5*	1.5		T <sub>C</sub> = 100°C, I <sub>FM</sub> = π × rated I <sub>F</sub> (AV)

\* JEDEC registered value

\*\* Suffix "S02" may be omitted, i.e., 12FL10 implies 12FL10S02, 12FL160 implies 12FL160S02.

① I<sub>R(AV)</sub> @ rated I<sub>F</sub>(AV) and V<sub>RRM</sub>, and T<sub>C</sub> = 100°C.

② I<sub>RM</sub> @ rated V<sub>RRM</sub> and T<sub>J</sub> = 150°C.

③ i<sub>2t</sub> for time t<sub>x</sub> = i<sub>2√t</sub> × √x

④ When these devices are ordered without a suffix, e.g., 40HFL, the order will be filled with devices that meet the S02 specification.

① Types listed are cathode to case; for anode-to-case include "R" in code, i.e., 1N3879R, 6FLR20S10, 16FLR40S02.

**Thermal and mechanical specifications**

	1N3879 1N3883 6FL...	1N3889 1N3893 12FL...	16FL...	Units	Conditions
$T_J$	Junction operating temperature range			-65 to 150	°C
$T_{stg}$	Storage temperature range			-65 to 175	°C
$R_{thJC}$	2.5	2.0	1.6	deg C/W	DC operation
$R_{thCS}$	Maximum thermal resistance, case to heatsink			0.5	deg C/W
T	Mounting torque	to nut	10.5	lb·in	Lubricated threads (Non-lubricated threads)
			0.12	kgf·m	
	to device		1.2	Nm	
			11.5 (13.5)	lb·in	
			0.13 (0.155)	kgf·m	
wt	Approximate weight			7	g
				0.25	oz
	Case style			DO-203AA (DC-4)	JEDEC

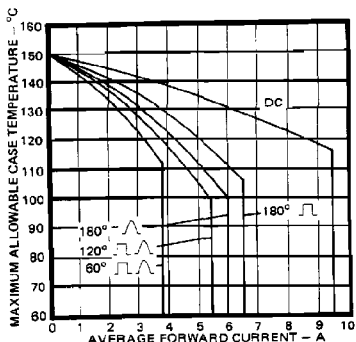

**Fig. 1 – Average Forward Current Vs. Maximum Allowable Case Temperature, 1N3879 and 6FL Series**

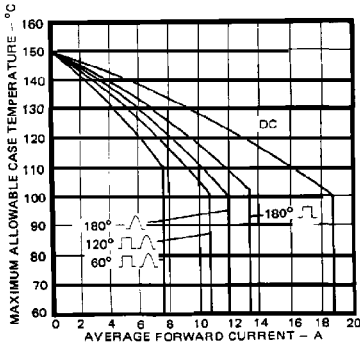

**Fig. 2 – Average Forward Current Vs. Maximum Allowable Case Temperature, 1N3889 and 12FL Series**

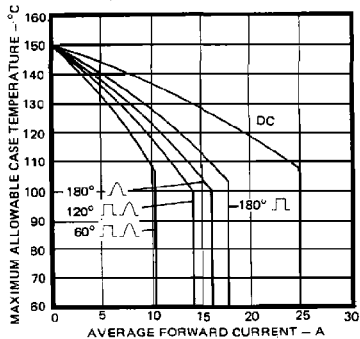

**Fig. 3 – Average Forward Current Vs. Maximum Allowable Case Temperature, 16FL Series**

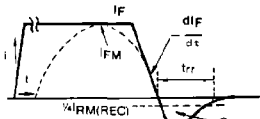

- $I_F, I_{FM}$  = Peak forward current prior to commutation
- $-di_F/dt$  = Rate of fall of forward current
- $I_{RM(REC)}$  = Peak reverse recovery current
- $t_{rr}$  = Reverse recovery time
- $Q_{RR}$  = Reverse recovered charge

**Fig. 4 – Reverse Recovery Time Test Waveform**

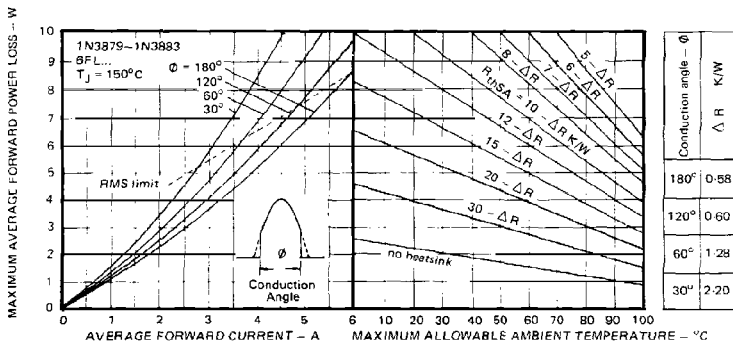

Fig. 5 - Current Rating Nomogram (Sinusoidal Waveforms), 1N3879 and 6FL Series

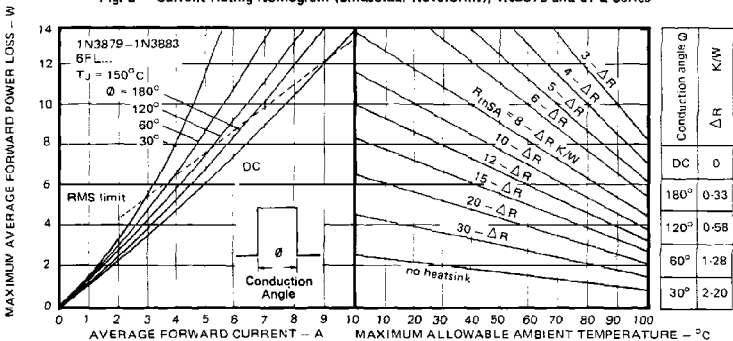

Fig. 6 - Current Rating Nomogram (Rectangular Waveforms), 1N3879 and 6FL Series

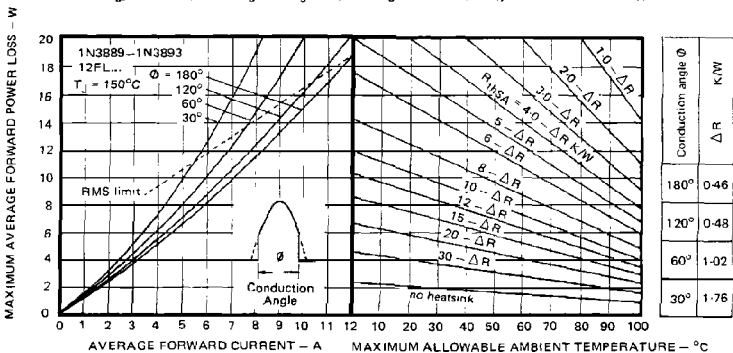

Fig. 7 - Current Rating Nomogram (Sinusoidal Waveforms), 1N3889 and 12FL Series

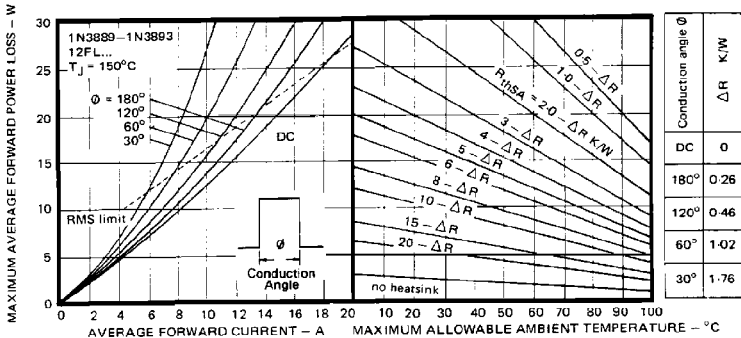

Fig. 8 - Current Rating Nomogram (Rectangular Waveforms), 1N3889 and 12FL Series

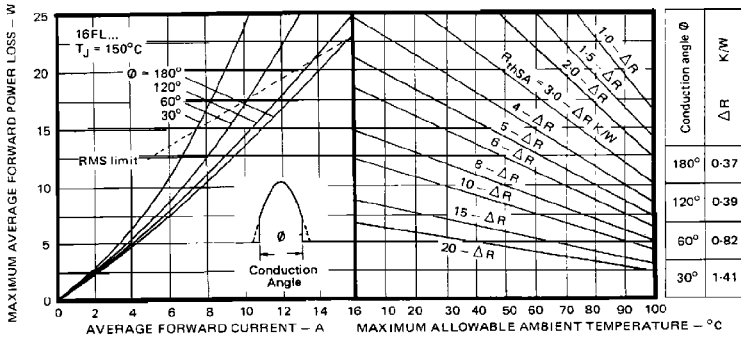

Fig. 9 - Current Rating Nomogram (Sinusoidal Waveforms), 16FL Series

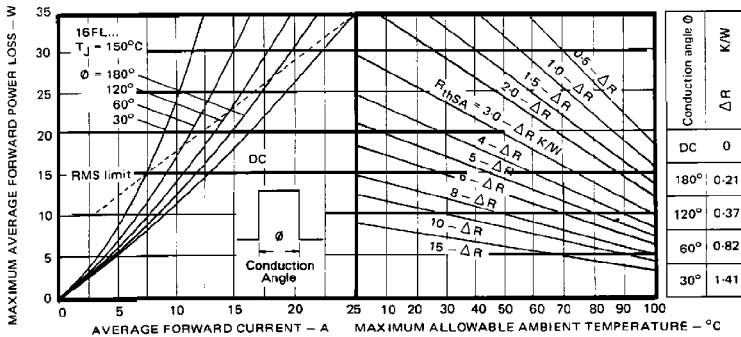

Fig. 10 - Current Rating Nomogram (Rectangular Waveforms), 16FL Series

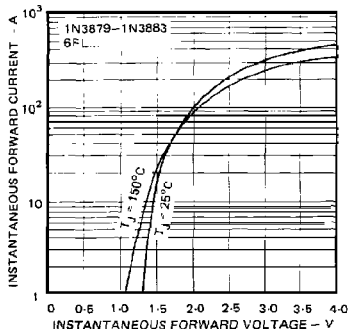

Fig. 11 - Maximum Forward Voltage Vs. Forward Current, 1N3879 and 6FL Series

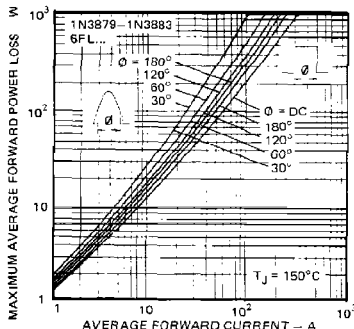

Fig. 12 - Maximum High Level Forward Power Loss Vs. Average Forward Current, 1N3879 and 6FL Series

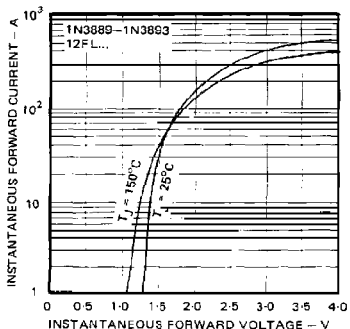

Fig. 13 - Maximum Forward Voltage Vs. Forward Current, 1N3889 and 12FL Series

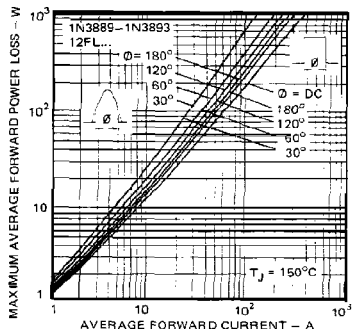

Fig. 14 - Maximum High Level Forward Power Loss Vs. Average Forward Current, 1N3889 and 12FL Series

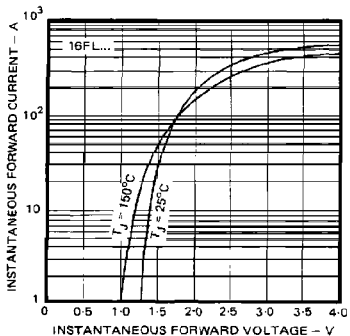

Fig. 15 - Maximum Forward Voltage Vs. Forward Current, 16FL Series

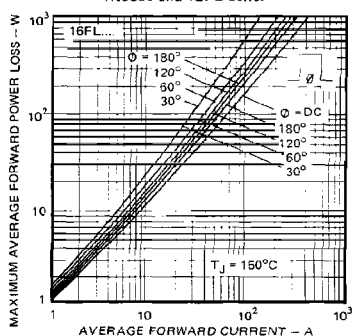

Fig. 16 - Maximum High Level Forward Power Loss Vs. Average Forward Current, 16FL Series

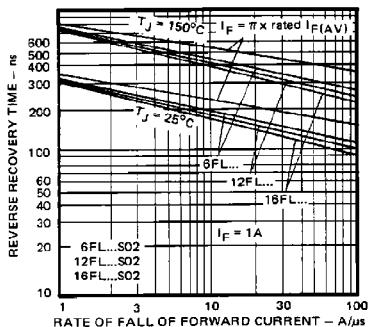

Fig. 17A — Maximum Reverse Recovery Time Vs. Rate of Fall of Forward Current, All Series \_\_S02

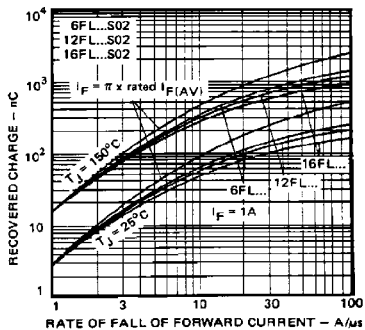

Fig. 17B — Maximum Recovered Charge Vs. Rate of Fall of Forward Current, All Series \_\_S02

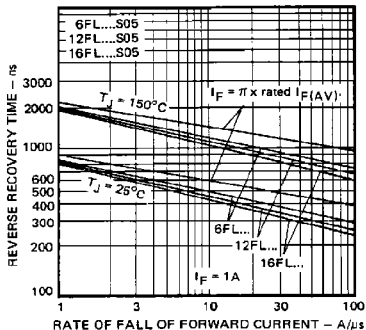

Fig. 18A — Maximum Reverse Recovery Time Vs. Rate of Fall of Forward Current, All Series \_\_S05

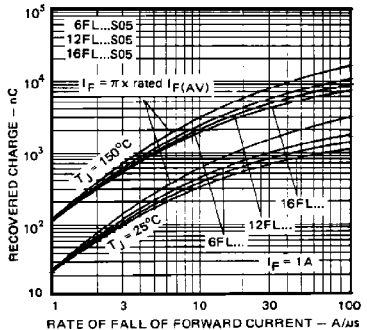

Fig. 18B — Maximum Recovered Charge Vs. Rate of Fall of Forward Current, All Series \_\_S05

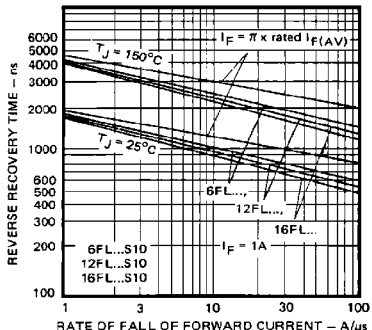

Fig. 19A — Maximum Reverse Recovery Time Vs. Rate of Fall of Forward Current, All Series \_\_S10

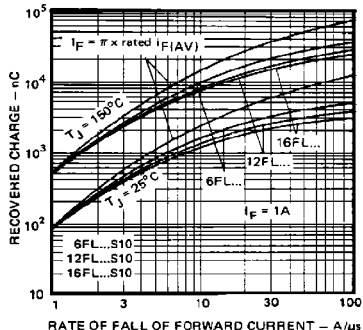

Fig. 19B — Maximum Recovered Charge Vs. Rate of Fall of Forward Current, All Series \_\_S10

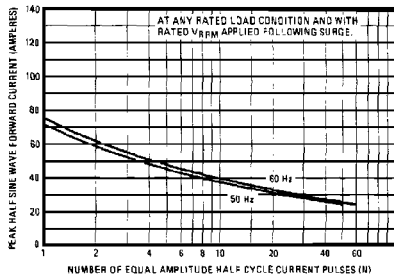

Fig. 20 — Maximum Non-Repetitive Surge Current Vs. Number of Current Pulses, 1N3879 Series

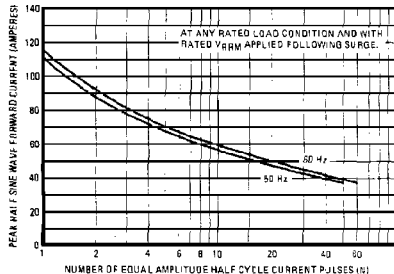

Fig. 21 — Maximum Non-Repetitive Surge Current Vs. Number of Current Pulses, 6FL Series

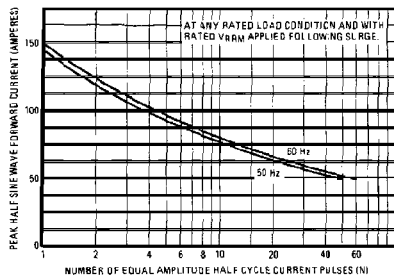

Fig. 22 — Maximum Non-Repetitive Surge Current Vs. Number of Current Pulses, 1N3889 and 12FL Series

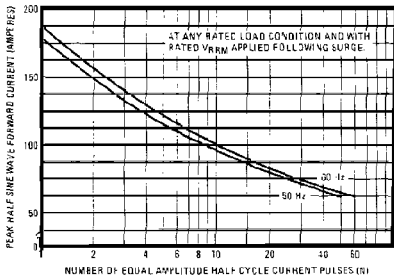

Fig. 23 — Maximum Non-Repetitive Surge Current Vs. Number of Current Pulses, 16FL Series

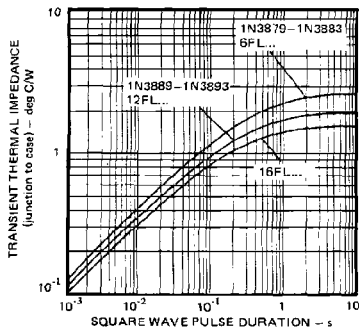

Fig. 24 — Maximum Transient Thermal Impedance, Junction-to-Case Vs. Pulse Duration, All Series.