



SPE6V8UN

Ultra Low Capacitance 2-Line ESD Protection Array

DESCRIPTION

The SPE6V8UN is 2-channel very low capacitance ESD transient voltage suppressor which provides a very high level of protection for sensitive electronic components that may be subjected to electrostatic discharge. It is particularly well-suited to protect systems with high speed communication lines from ESD, EFT, and lightning.

The SPE6V8UN consists of two low capacitance steering diodes and a TVS diode in SOT-353 package. Each channel of SPE6V8UN could safely dissipate ESD strikes of $\pm 15\text{kV}$ air discharge as well as $\pm 8\text{kV}$ contact discharge, meeting the requirement of the IEC 61000-4-2 international standard. Using the MIL-STD-883 (Method 3015) specification for Human Body Model (HBM) ESD, the device provides protection for contact discharges to greater than $\pm 15\text{kV}$.

FEATURES

- ◆ Transient protection for data lines to

IEC 61000-4-2 (ESD)
 $\pm 15\text{kV}$ (air)
 $\pm 8\text{kV}$ (contact)

www.DataSheet4U.com IEC 61000-4-4 (EFT)
 40A (5/50ns)

- ◆ Protects five bidirectional I/O lines
- ◆ Working voltage: 5V
- ◆ Low leakage current
- ◆ Low operating and clamping voltages
- ◆ Low capacitance: 0.7 pF typical

APPLICATIONS

- ◆ Cellular Handsets and Accessories
- ◆ Cordless Phone
- ◆ PDA
- ◆ Notebooks and Handhelds
- ◆ Portable Instrumentation
- ◆ Digital Cameras
- ◆ MP3 Player High Definition Multi-Media Interface Protection
- ◆ USB 2.0 Power and Data Line
- ◆ Monitors and Notebook Computers
- ◆ HDSL, IDSL Secondary IC Side Protection
- ◆ 10/100/1000 Ethernet

PIN CONFIGURATION (SOT-353)

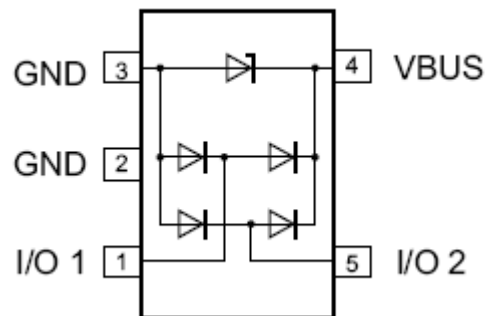

PART MARKING

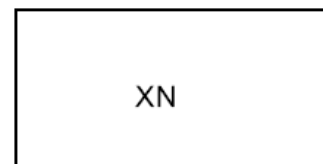

X =Date Code

N=Specific Device Code



SPE6V8UN

Ultra Low Capacitance 2-Line ESD Protection Array

ORDERING INFORMATION

Part Number	Package	Part Marking
SPE6V8UNS35RGB	SOT-353	6V8U YYWW

※ SPE6V8UNS35RGB : Tape Reel ; Pb – Free ; Halogen - Free

ABSOLUTE MAXIMUM RATINGS

(TA=25°C Unless otherwise noted)

Parameter	Symbol	Typical	Unit
Peak Pulse Power (tp = 8/20 μs)	Ppk	180	W
Maximum Peak Pulse Current (tp = 8/20 μs)	Ipp	7	A
ESD per ICE 61000 – 4 – 2 (Air)	Vpp	±15	KV
ESD per ICE 61000 – 4 – 2 (Contact)	Vpp	±8	KV
Operating Junction Temperature	Tj	-55 ~ 150	°C
Storage Temperature Range	TSTG	-55 ~ 150	°C
Lead Soldering Temperature	TL	260 (10sec)	°C

ELECTRICAL CHARACTERISTICS

(TA=25°C Unless otherwise noted)

Parameter	Symbol	Conditions	Min.	Typ	Max.	Unit
Reverse Stand – Off Voltage	VRWM				5	V
Forward Voltage @ IF	VF	IF = 10mA	0.4	0.8	1.5	V
Reverse Breakdown Voltage	VBR	It = 1mA	6.0	7.0		V
Reverse Leakage Current	IR	VRWM = 5V , T=25°C		0.01	1	μA
Reverse Leakage Current	IR	VRWM = 3V , T=25°C		0.01	0.5	μA
Clamping Voltage	VC	Ipp = 1A , tp = 8/20 μs			12	V
Junction Capacitance	Cj	VR = 0V, f = 1MHz Any I/O pin to Ground		1.4	1.5	pF
		VR = 0V, f = 1MHz Between I/O pins		0.7		



SPE6V8UN

Ultra Low Capacitance 2-Line ESD Protection Array

TYPICAL CHARACTERISTICS

Non-Repetitive Peak Pulse Power vs. Pulse Time

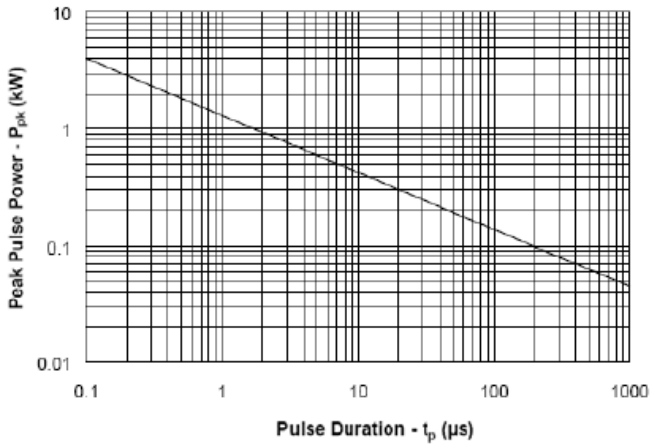

Power Derating Curve

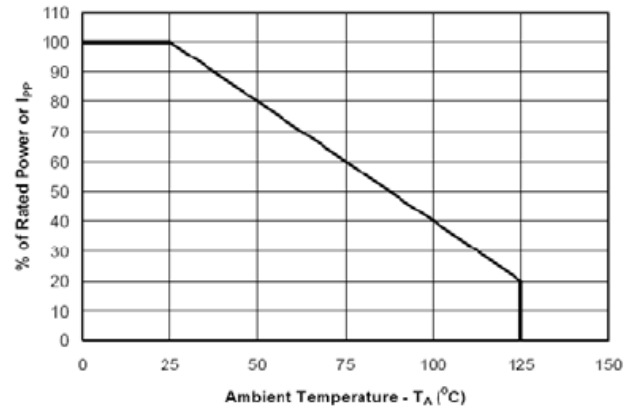

Clamping Voltage vs. Peak Pulse Current

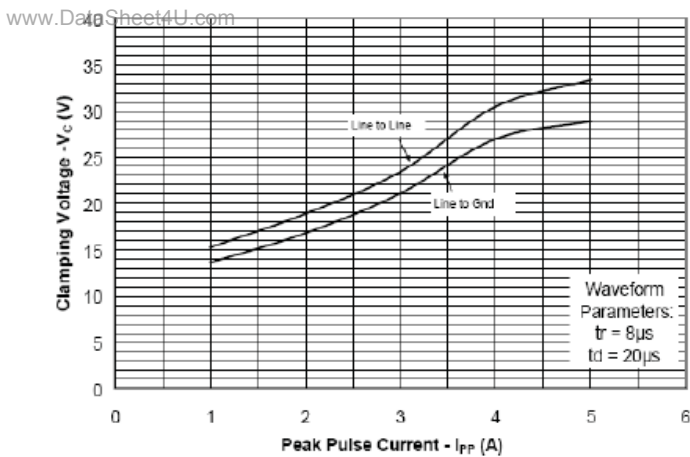

Forward Voltage vs. Forward Current

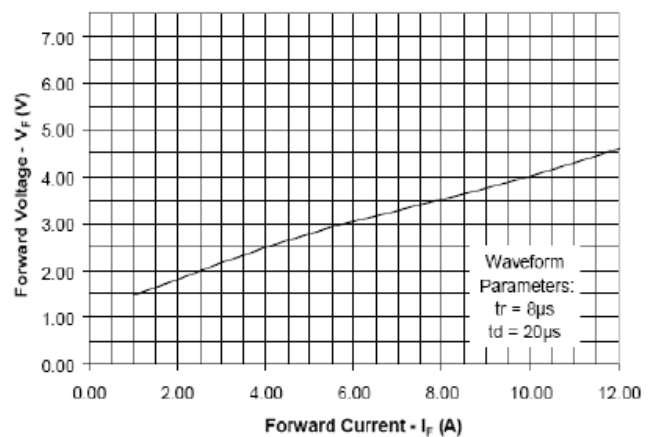



SPE6V8UN

Ultra Low Capacitance 2-Line ESD Protection Array

SOT-353 PACKAGE OUTLINE

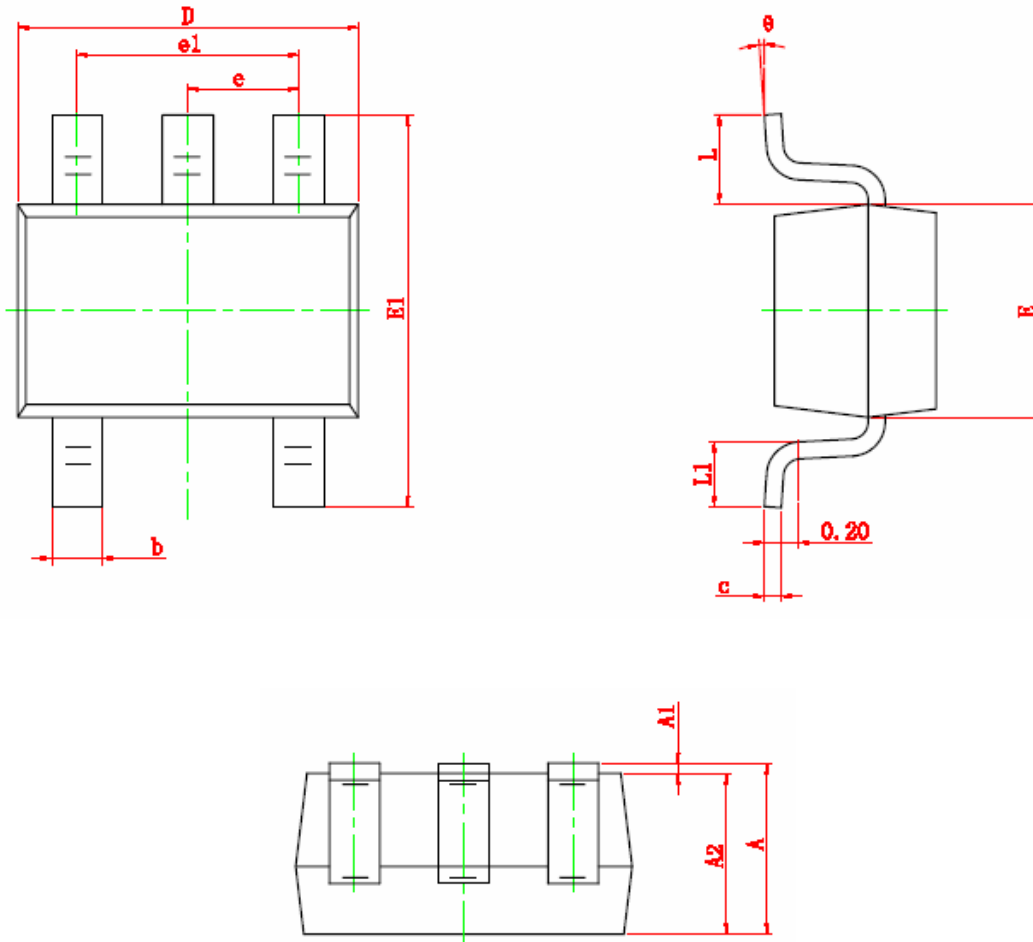

www.DataSheet4U.com

Symbol	Dimensions In Millimeters		Dimensions In Inches	
	Min	Max	Min	Max
A	0.900	1.100	0.035	0.043
A1	0.000	0.100	0.000	0.004
A2	0.900	1.000	0.035	0.039
b	0.150	0.350	0.006	0.014
c	0.080	0.150	0.003	0.006
D	2.000	2.200	0.079	0.087
E	1.150	1.350	0.045	0.053
E1	2.150	2.450	0.085	0.096
e	0.650 TYP		0.026 TYP	
e1	1.200	1.400	0.047	0.055
L	0.525 REF		0.021 REF	
L1	0.260	0.460	0.010	0.018
theta	0°	8°	0°	8°



SPE6V8UN

Ultra Low Capacitance 2-Line ESD Protection Array

www.DataSheet4U.com

Information provided is alleged to be exact and consistent. SYNC Power Corporation presumes no responsibility for the penalties of use of such information or for any violation of patents or other rights of third parties which may result from its use. No license is granted by allegation or otherwise under any patent or patent rights of SYNC Power Corporation. Conditions mentioned in this publication are subject to change without notice. This publication surpasses and replaces all information previously supplied. SYNC Power Corporation products are not authorized for use as critical components in life support devices or systems without express written approval of SYNC Power Corporation.

©The SYNC Power logo is a registered trademark of SYNC Power Corporation

©2004 SYNC Power Corporation – Printed in Taiwan – All Rights Reserved

SYNC Power Corporation

7F-2, No.3-1, Park Street

NanKang District (NKSP), Taipei, Taiwan, 115, R.O.C

Phone: 886-2-2655-8178

Fax: 886-2-2655-8468

©<http://www.syncpower.com>