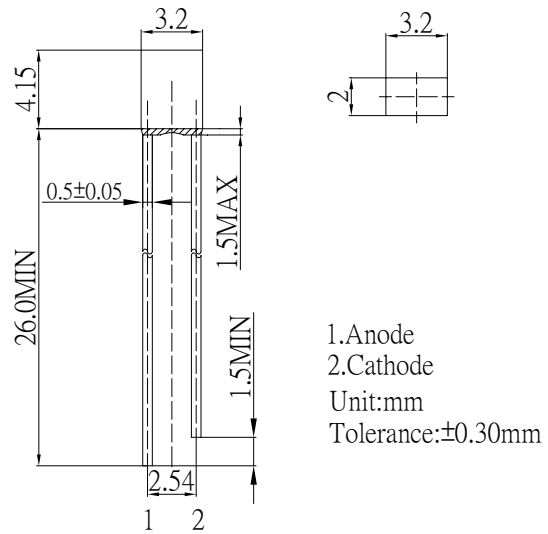

■ Features

- High Luminous LEDs
- 2x3x4mm Rectangular Standard Directivity
- Superior Weather-resistance
- UV Resistant Epoxy
- Water Clear Type

■ Applications

- Traffic Signal
- Backlighting
- Signal and channel letter
- Other Lighting

■ Outline Dimension

■ Absolute Maximum Rating

(Ta=25°C)

Item	Symbol	Value	Unit
DC Forward Current	I_F	50	mA
Pulse Forward Current*	I_{FP}	120	mA
Reverse Voltage	V_R	5	V
Power Dissipation	P_D	130	mW
Operating Temperature	T_{opr}	-30 ~ +85	°C
Storage Temperature	T_{stg}	-40 ~ +100	°C
Lead Soldering Temperature	T_{sol}	260°C / 5sec	-

*Pulse width Max.10ms Duty ratio max 1/10

■ Electrical -Optical Characteristics

(Ta=25°C)

Item	Symbol	Condition	Min.	Typ.	Max.	Unit
DC Forward Voltage	V_F	$I_F=20mA$	1.8	2.1	2.6	V
DC Reverse Current	I_R	$V_R=5V$	-	-	10	μA
Domi. Wavelength*	λ_D	$I_F=20mA$	620	625	630	nm
Luminous Intensity*	I_v	$I_F=20mA$	750	1200	-	mcd
50% Power Angle	$2\theta_{1/2}$	$I_F=20mA$	-	100	-	deg

*1 Tolerance of dominant wavelength is ±1nm

*2 Tolerance of luminous intensity is ±15%

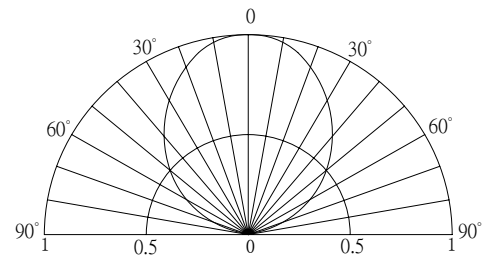
■ Directivity

■ Maximum Forward Current

 Maximum Permissible Forward Current $T_J=115^\circ C$
